

Curs 7

2025/2026

Programarea aplicațiilor web

PAW

- Programarea aplicațiilor web
 - An V RC
 - 1.5C/1L/1P

Program

- An V
 - Saptamana 1
 - Luni 17-20 Curs (Intro/HTML/CSS)
 - Saptamanile **2-8**
 - Luni 16:30-18 Curs
 - Luni **18-20 Laborator**
 - Saptamanile **9-14**
 - Luni 16:30-18 Curs
 - Luni **18-20 Proiect**

Orar

- <https://orar.etti.tuiasi.ro/> : C->16:30-18, L/P -> 18

Grupa: 55RC Profesor: Alege un profesor Sala: Alege o sala



FACULTATEA DE ELECTRONICA, TELECOMUNICATII SI TEHNOLOGIA INFORMATIEI

55RC

11111111

	1	2	3	4	5	6	7	8	9	10	11	12
	8:00 - 8:50	9:00 - 9:50	10:00 - 10:50	11:00 - 11:50	12:00 - 12:50	13:00 - 13:50	14:00 - 14:50	15:00 - 15:50	16:00 - 16:50	17:00 - 17:50	18:00 - 18:50	19:00 - 19:50
L										PAW (C) 2.13 TC (R)	Damian R. PAW (P) 2.13 TC (R)	Damian R. PAW (L) 2.13 TC (R)
Ma								RCALSC (C) 2.13 TC (R)	Scripcariu L. RCALSC (L) 2.13 TC (R)		Mocanu F. RCALSC (L) 2.13 TC (R)	
Mi									Bozomitu R. SRDS (L) 3.20 Antene			
J						Iov C. Etic (C) Amf. C1 (Corp C)					Trifina L. TEFO (L) 3.25 TTI (L)	Trifina L. TEFO (L) 3.25 TTI (L)
V									Trifina L. TEFO (C) P8 (Amf.)	Bozomitu R. SRDS P8 (Amf.)	Iov C. Etic (S) P7 (Amf.)	
Sâ												

Nota

- An V
 - 33% E
 - 66% Aplicatii
 - 33% L
 - 33% P

Documentatie

- <https://rf-opto.etti.tuiasi.ro> + WWW

The screenshot shows a web browser window with the URL `rf-opto.etti.tuiasi.ro/master_it.php`. The page has a dark blue navigation bar with links for Main, Courses, Master (highlighted), Staff, Research, Students, and Admin. Below this is a secondary navigation bar with links for Radiocommunication Systems, Microwave IC, Satellite Comm., Web Design (highlighted), and Ethics. The main content area features a list of links for exam materials: Online Exam manual (pdf, 2.56 MB, en), Manual examen on-line (pdf, 2.65 MB, ro), Simulare Examen (video) (mp4, 65.12 MB, ro), and Exam Simulation (video) (mp4, 41.96 MB, en). The main heading is **Web Applications Design**, followed by **Course: PAW (2024-2025)**. The course coordinator is Assoc.P. Dr. Radu-Florin Damian, with code RC.IA.108. The discipline type is DIMS, required, synthesis, with 5 credits. Enrollment is for year 5, semester 10. The activities section lists the instructor as Assoc.P. Dr. Radu-Florin Damian, 1.5 hours/week, specialization section, with a timetable. The evaluation section lists the type as Exam, with a breakdown: A: 33.33% (Test/Colloquium), B: 33.33% (Seminary/Laboratory/Project Activity), and D: 33.33% (Homework/Specialty papers). The previous years section shows a table with buttons for 2023-2024, 2022-2023, 2021-2022, 2020-2021, 2019-2020, and More years...

Acces

- Personalizat (parola), Generic (email)



A student profile page with a blue header. On the left is a blurred student photo. To the right, under the heading "Date:", is a table with student details. Below the table is a link "Acceseaza ca acest student" circled in red. At the bottom is a table titled "Note obtinute" showing exam results for "Tehnologii Web".

Date:

Grupa	5304 (2015/2016)
Specializarea	Tehnologii si sisteme de telecomunicatii
Marca	5184

[Acceseaza ca acest student](#)

Note obtinute

Disciplina	Tip	Data	Descriere	Nota	Puncte	Obs.
TW			Tehnologii Web			
N		17/01/2014	Nota finala	10	-	
A		17/01/2014	Colocviu Tehnologii Web 2013/2014	10	7.55	
B		17/01/2014	Laborator Tehnologii Web 2013/2014	9	-	
D		17/01/2014	Tema Tehnologii Web 2013/2014	9	-	

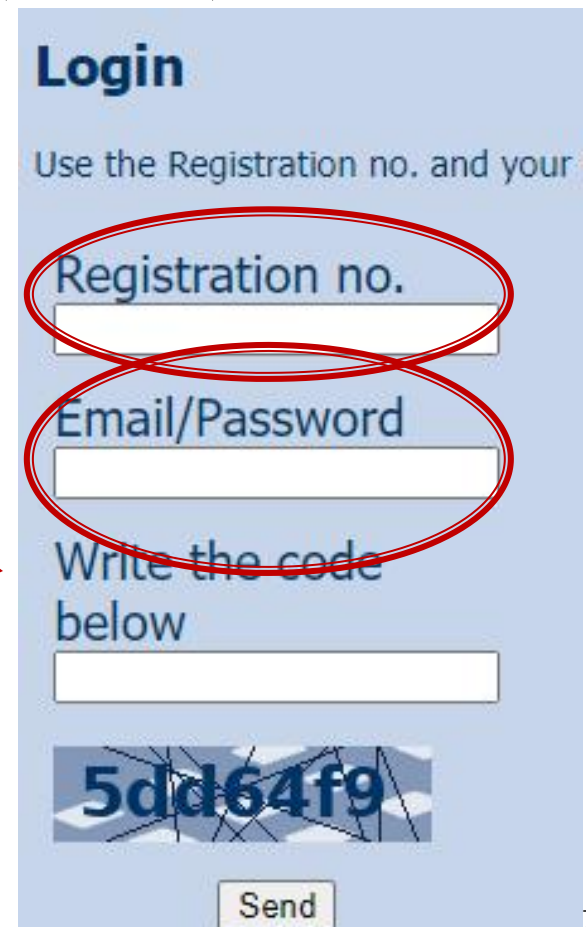

A login form with a blue header. It contains fields for "Registration no.", "Email/Password", and a CAPTCHA. A "Send" button is at the bottom. Red circles highlight the "Registration no." and "Email/Password" fields, and a red arrow points from the link in the previous image to the "Registration no." field.

Login

Use the Registration no. and your

Registration no.

Email/Password

Write the code below

5dd64f9

Send

Online – Numar matricol (marca)

- accesul la **examene** necesita **parola** primita prin email

The password is communicated during the lectures. It is necessary t

Password

Registration no.

Name of the student

Proposed email 1

Proposed email 2

Write the code below

6fb6953

 **RF-OPTO** 

English | Romana |

[Main](#) [Courses](#) [Master](#) [Staff](#) [Research](#) [Students](#)

[Login](#) [Tutoring](#)

Login

Use the Registration no. and your email or the password received by email

Registration no.

Email/Password

Write the code below

5dd64f9

Parola

■ primita prin email

Important message from RF-OPTO

Inbox x



Radu-Florin Damian

to me, POPESCU

Romanian > English Translate message



Laboratorul de Microunde si Optoelectronica
Facultatea de Electronica, Telecomunicatii si Tehnologia Informatiei
Universitatea Tehnica "Gh. Asachi" Iasi

In atentie: POPESCU GOPO ION

Parola pentru a accesa examenele pe server-ul rf-opto este
Parola: [REDACTED]

Identificati-va pe [server](#), cu parola, cat mai rapid, pentru confirmare.

Memorati acest mesaj intr-un loc sigur, pentru utilizare ulterioara

Attention: POPESCU GOPO ION

The password to access the exams on the rf-opto server is
Password: [REDACTED]

Login to the [server](#), with this password, as soon as possible, for confirmation.

Save this message in a safe place for later use

Reply

Reply all

Forward

Subject: Important message from RF-OPTO

Validation of MD/CR exam from 02/05/2020

From: Me <rdamian@etti.tuiasi.ro>

Subject: Important message from RF-OPTO

To: [REDACTED]

Cc: Me <rdamian@etti.tuiasi.ro>



Laboratorul de Microunde si Optoelectronica
Facultatea de Electronica, Telecomunicatii si Tehnologia Informatiei
Universitatea Tehnica "Gh. Asachi" Iasi

In atentie: POPESCU GOPO ION

Parola pentru a accesa examenele pe server-ul rf-opto este
Parola: [REDACTED]

Identificati-va pe [server](#), cu parola, cat mai rapid, pentru confirmare.

Memorati acest mesaj intr-un loc sigur, pentru utilizare ulterioara

Attention: POPESCU GOPO ION

The password to access the exams on the rf-opto server is
Password: [REDACTED]

Login to the [server](#), with this password, as soon as possible, for confirmation.

Save this message in a safe place for later use

Manual examen online

- Aplicatia de examen online utilizata la:
 - ~~curs (prezenta)~~
 - laborator -> Activitate suplimentara
 - proiect -> Alocare/predare proiect
 - ~~examen~~

Materials

Other data

[Manual examen on-line](#) (pdf, 2.65 MB, ro, 🇷🇴)

[Simulare Examen](#) (video). (mp4, 65.12 MB, ro, 🇷🇴)

Microwave Devices and Circuits (Englis

Examen online

- intotdeauna **contratimp**
 - perioada lunga (proiect, activitate suplimentara)
 - ~~perioada scurta (teste: 15min, examen: 2h)~~

The screenshot shows a web interface for an online exam system. At the top, there is a navigation menu with the following items: Start, Didactic, Master, Colectiv, Cercetare, and **Studenti**. Below this, there is a sub-menu with: Note, Lista Studenti, **Examene**, and Fotografii. A horizontal timeline of exam stages is displayed, with the first stage, 'Anunț 17:28 (29/04/2020)', highlighted with a red circle. The other stages are: 'Material suport 17:30 (29/04/2020)', 'Subiecte 17:32 (29/04/2020)', 'Rezultate 17:35 (29/04/2020)', 'Finalizare 17:45 (29/04/2020)', and 'Confirmare 17:45 (30/04/2020)'. To the right of this timeline, a red circle highlights a message: 'Urmatorul interval de timp in. 01 m 08 s Reincarca acum'. Below the timeline, the section 'Anunț' is visible, with the text 'In acest examen se verifica diverse actiuni ale studentilor pentru examen'. Underneath, the section 'Ora pe server' is shown, with the text 'Toate examenele sunt bazate pe fusul orar al server-ului (ar putea sa fie diferit de timpul local). Pentru referinta ora pe server este acum: 29/04/2020 17:28:51', where the timestamp is circled in red.

Anunț 17:28 (29/04/2020)	Material suport 17:30 (29/04/2020)	Subiecte 17:32 (29/04/2020)	Rezultate 17:35 (29/04/2020)	Finalizare 17:45 (29/04/2020)	Confirmare 17:45 (30/04/2020)
-----------------------------	---------------------------------------	--------------------------------	---------------------------------	----------------------------------	----------------------------------

Urmatorul interval de timp in.
01 m 08 s
[Reincarca acum](#)

Anunț

In acest examen se verifica diverse actiuni ale studentilor pentru examen

Ora pe server

Toate examenele sunt bazate pe fusul orar al server-ului (ar putea sa fie diferit de timpul local). Pentru referinta ora pe server este acum:
29/04/2020 17:28:51

Nota

- An V
 - 33% E
 - 33% L
 - 33% P
- Laborator - Prezenta
 - 1pz = 1p ($p > 5 \leftrightarrow$ Curs)
- Examen
 - Prezenta la curs: 3pz = 0.5p
 - Asemanator cu materia de **proiect**
- Activitate suplimentara
 - Dupa terminarea activitatii la laborator
 - +2p la E/L

Recapitulare

Tablou = Arbore

- In particular, una sau mai multe dintre din valori poate fi la randul ei tablou, ducand la **ramificarea** arborelui
- \$tabl = array(cheie1 => val_1, cheie2 => array(cheie2a => val_a, cheie2b => val_b, cheie2c => val_c), cheie3 => val_3)

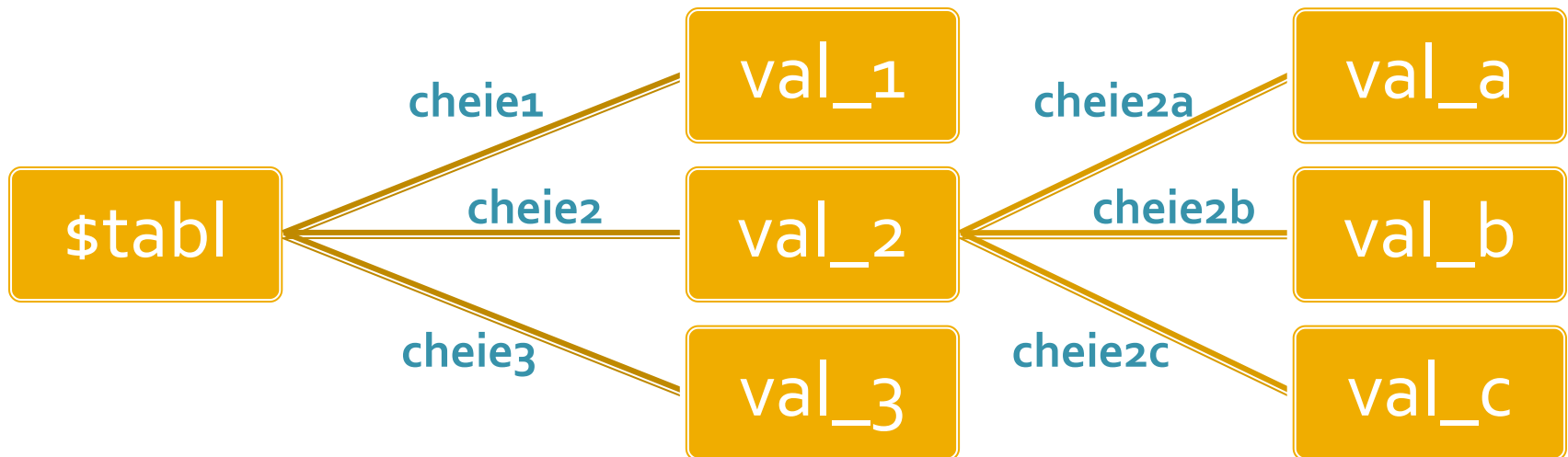

Elemente de control – foreach

- `foreach (array_expression as $key => $value) statement`
- `foreach (array_expression as $value) statement`
- iterarea prin **fiecare** element al tabloului
- la fiecare element variabila declarata in instructiune variabila locala **\$key** ofera acces la cheia curenta iar variabila locala **\$value** ofera acces la valoarea asociata
- `foreach()` lucreaza cu o **copie** a tabloului deci tabloul original nu va fi modificat prin schimbarea continutului variabilelor `$key` si `$value`

Variabile globale

Variabile globale

- Variabilele globale (predefinite)
 - accesibile script-urilor PHP prin conlucrarea cu server-ul
 - Exemple:
 - `$_SERVER` — Server and execution environment information
 - `$_GET` — HTTP GET variables
 - `$_POST` — HTTP POST variables
 - `$_FILES` — HTTP File Upload variables
 - `$_REQUEST` — HTTP Request variables
 - `$_SESSION` — Session variables
 - `$_ENV` — Environment variables
 - `$_COOKIE` — HTTP Cookies

Interactiunea cu utilizatorul

- Datele introduse de utilizator in forme se regasesc (in functie de metoda aleasa pentru forma) in una din variabilele:
 - `$_POST` – `method="post"`
 - `$_GET` – `method="get"`
 - `$_REQUEST` – ambele metode
- variabilele sunt **tablouri** cu **cheia** data de atributul **name** din forma HTML
 - `<input type="text" name="carti_cant" size="3" maxlength="3" />`
 - `$_POST['carti_cant']` contine valoarea introdusa de utilizator

Subdivizare \$_POST

- realizand atributul **name** ca tablou, se obtine in \$_POST un "subtablou" (ramificare locala a arborelui) care grupeaza elementele input
 - `<input type="text" name="cant[carti]" size="3" maxlength="3" />`
 - `$_POST ['cant'] ['carti']` contine valoarea introdusa
- Este necesar pentru a grupa elementele similare pe care sa le prelucram la receptie cu **foreach**
- \$_POST contine si alte elemente pe care le dorim eventual tratate separat
 - numele (name) si valoarea butonului "submit" apar in \$_POST de exemplu

Includerea / controlul formei in fisierile PHP - Template

Template

- Sablon
- controlul simultan al formei pentru toate paginile din site
- separarea aplicatiei de forma

Exemplu – design 2

- sectiunile repetabile pot fi mutate intr-un fisier separat si introduse cu require()
- se identifica zonele comune

```
<html>
<head>
<title>Magazin online Firma X SRL</title>
</head>
<body bgcolor="#CCFFFF">
<table width="600" border="0" align="center">
<tr><td></td></tr>
<tr><td height="600" valign="top"
bgcolor="#FFFFCC">
Continut
</td></tr>
</table>
</body>
</html>
```

Lista produse

antet.php

```
<html>
<head>
<title>Magazin online Firma X
SRL</title>
</head>
<body bgcolor="#CCFFFF"><?php
define('PRET_CARTE',100);
define('PRET_CALET',50);
define('PRET_PENAR',150);
define('PRET_STILOU',125);
define('PRET_CREION',25);
//orice cod comun PHP
?><table width="600" border="0"
align="center">
<tr><td></td></tr>
<tr><td height="600" valign="top"
bgcolor="#FFFFCC">
<h1>Magazin online Firma X SRL</h1>
```

subsol.php

```
</td></tr>
</table>
</body>
</html>
```

*.php

```
<?php require('antet.php');?>
<h2>Lista Produse</h2>
<table border="1">
...
</table>
<?php require('subsol.php');?>
```

Lista categorii

- Aparitia categoriilor aduce necesitatea transmiterii de catre utilizator a informatiei despre categoria selectata

Categorii Produse

Alegeti categoria:

Nr.	Categorie	Total Produse
1	Papetarie	3
2	Instrumente	3
3	Audio-video	3
4	Calculatoare	3
5	Jucarii	2

Total produse: 14

Magazin online Firma X SRL

Realizati comanda

Nr.	Produs	Pret	Cantitate
1	Carti	100	<input type="text" value="1"/>
2	Caiete	50	<input type="text" value="2"/>
3	Penare	150	<input type="text" value="1"/>
4	Stilouri	125	<input type="text" value="0"/>
5	Creioane	25	<input type="text" value="0"/>

Trimite

Metode de transmitere

- **post** datele sunt transmise in bloc
- **get** datele sunt atasate adresei documentului de procesare : `results.php?prob=81&an=2009`
- se poate simula realizarea unei forme (**get**) prin scrierea corespunzatoare a link-urilor

Transmitere prin GET

- in `lista_categ.php`
 - `<a href="lista_prod.php?categ=<?php echo $cat;?>"> <?php echo $cat;?> `
- are efect in `lista_prod.php`
 - `$_GET['categ']="valoarea $cat corespunzatoare"`

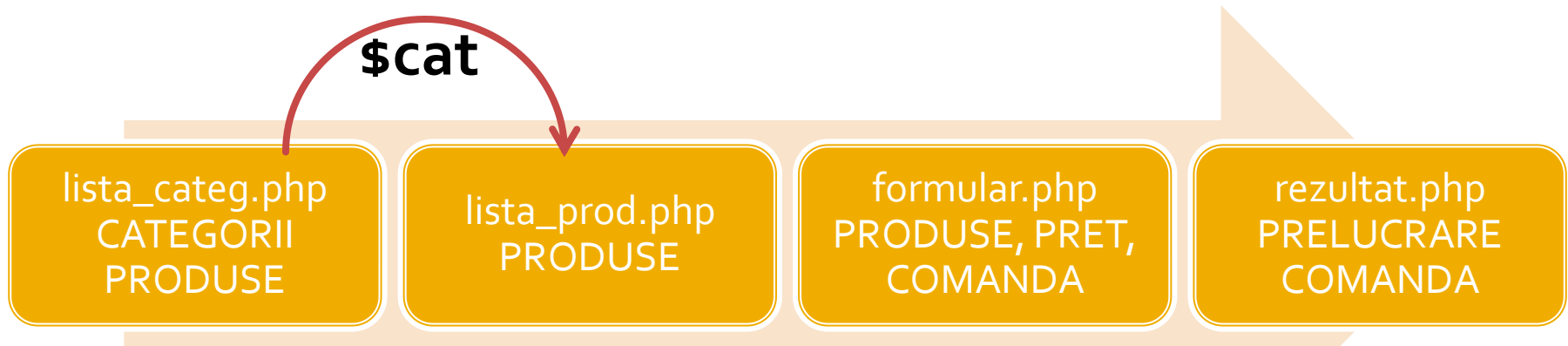

Memorarea datelor

Crearea fisierului

- crearea initiala se poate face prin modificarea o singura data a fisierului antet.php existent astfel incat sa scrie datele pe disc

```
$produse = array ( 'carte' => array ("descr" => "mai multe pagini scrise", "pret" => 100, "cant" => 0),  
                  'caiet' => array ("descr" => "mai multe pagini goale", "pret" => 50, "cant" => 0),  
                  'penar' => array ("descr" => "loc de depozitat instrumente", "pret" => 150, "cant" => 0),  
                  'stilou' => array ("descr" => "instrument de scris albastru", "pret" => 125, "cant" => 0),  
                  'creion' => array ("descr" => "instrument de scris gri", "pret" => 25, "cant" => 0)  
                );  
$handle = fopen("produse.txt", "wb");  
foreach ($produse as $prod => $detalii)  
    fwrite($handle,$prod."\t".$detalii['descr']."\t".$detalii['pret']."\t".$detalii['cant']."\r\n");
```

produse.txt

- se pot utiliza si alte caractere pentru separare
 - esential: sa nu apara in date
 - TAB are efect vizual si in fisiere text

carte	mai multe pagini scrise legate	100	0	
caiet	mai multe pagini goale legate	75	0	
penar	loc de depozitat instrumente de scris	150	0	
stilou	instrument de scris albastru	125	0	
creion	instrument de scris gri	25	0	

Rezolvare

- modificarea fisierului text cu introducerea categoriei ca prim parametru in fisier

carte	mai multe pagini scrise legate	100	0	
caiet	mai multe pagini goale legate	75	0	
penar	loc de depozitat instrumente de scris	150	0	
stilou	instrument de scris albastru	125	0	
papetarie	carte	mai multe pagini scrise legate	100	0
papetarie	caiet	mai multe pagini goale legate	75	0
instrumente	penar	loc de depozitat instrumente de scris	150	0
instrumente	stilou	instrument de scris albastru	125	0

Adaugare categorii (lab 5)

- adaugare nivel in "arbore"

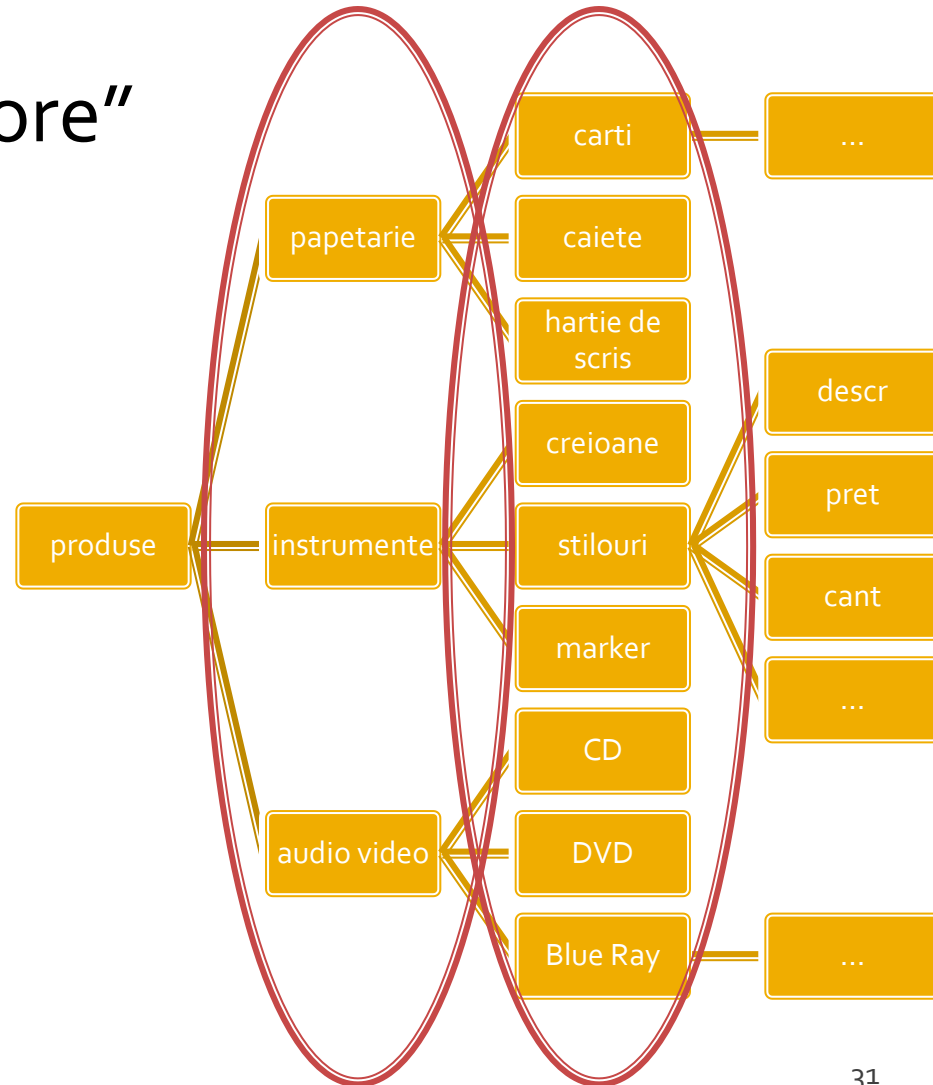
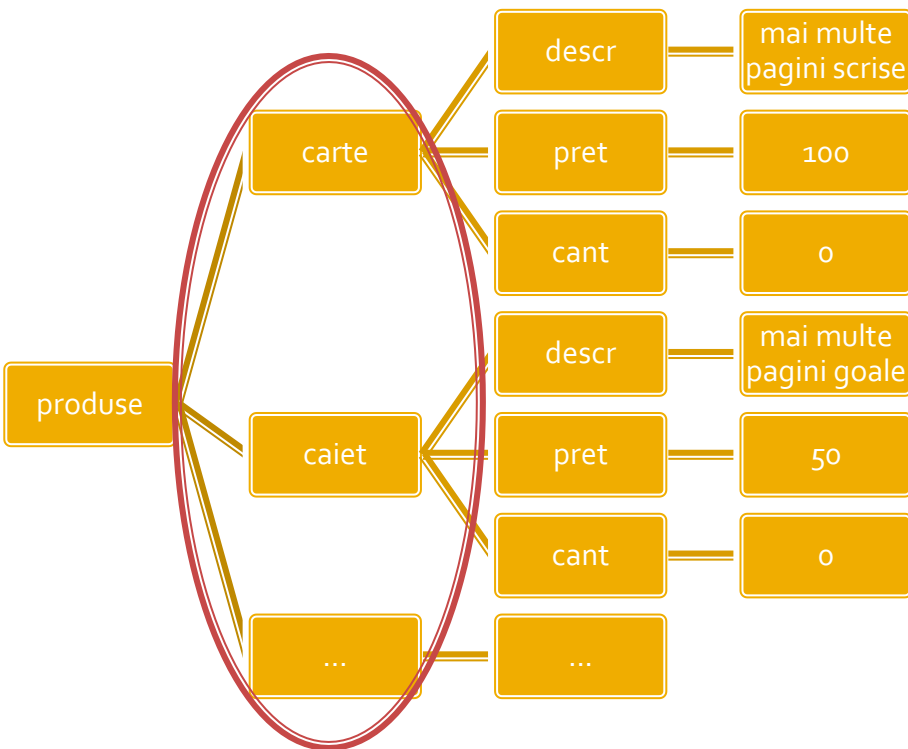

Cod

- Codul ramane in mare parte acelasi
- Cateva modificari sunt necesare

```
$vect=file("produse.txt");  
foreach ($vect as $linie)  
    {  
        $valori=explode("\t",$linie,4);  
        $produse[$valori[0]]=array ("descr" => $valori[1], "pret" => $valori[2], "cant" => $valori[3]);  
    }
```

```
$vect=file("produse.txt");  
foreach ($vect as $linie)  
    {  
        $valori=explode("\t",$linie,5);  
        $produse[$valori[0]] [$valori[1]]=array ("descr" => $valori[2], "pret" => $valori[3], "cant" =>  
$valori[4]);  
    }
```

Acces la date

- Utilizare, cu doua bucle foreach

```
$index=1;
foreach ($produse as $prod => $detalii) //primul indice in $produse imi da produsul
    {?>
<tr><td><?php echo $index;?></td><td><?php echo ucfirst(strtolower($prod));?></td><td><?php echo
$detalii['descr'];?></td><td align="center"><?php echo $detalii['pret'];?></td></tr>
<?php $index++;
    }
```



```
$index=1;
foreach ($produse as $categ => $lista_categ) //primul indice in $produse imi da categoria
    foreach ($lista_categ as $prod => $detalii) //al doilea indice in $produse imi da produsul
        //din categoria stabilita cu primul indice
        {?>
<tr><td><?php echo $index;?></td><td><?php echo $categ;?></td><td><?php echo
ucfirst(strtolower($prod));?></td><td><?php echo $detalii['descr'];?></td><td align="center"><?php
echo $detalii['pret'];?></td></tr>
<?php $index++;
        }
```

XML

- `<element1 atribut1 = "valoare" ... >`
 - `<element2 atribut2 = "valoare">`
 - `<element3>...</element3>`
 - ...
 - `</element2>`
 - ...
- `</element1>`
- ...
- `<element1>`
- `</element1>`

Continuare

! Important

- Laborator **asincron!**

- recomandat – 4 = Optim

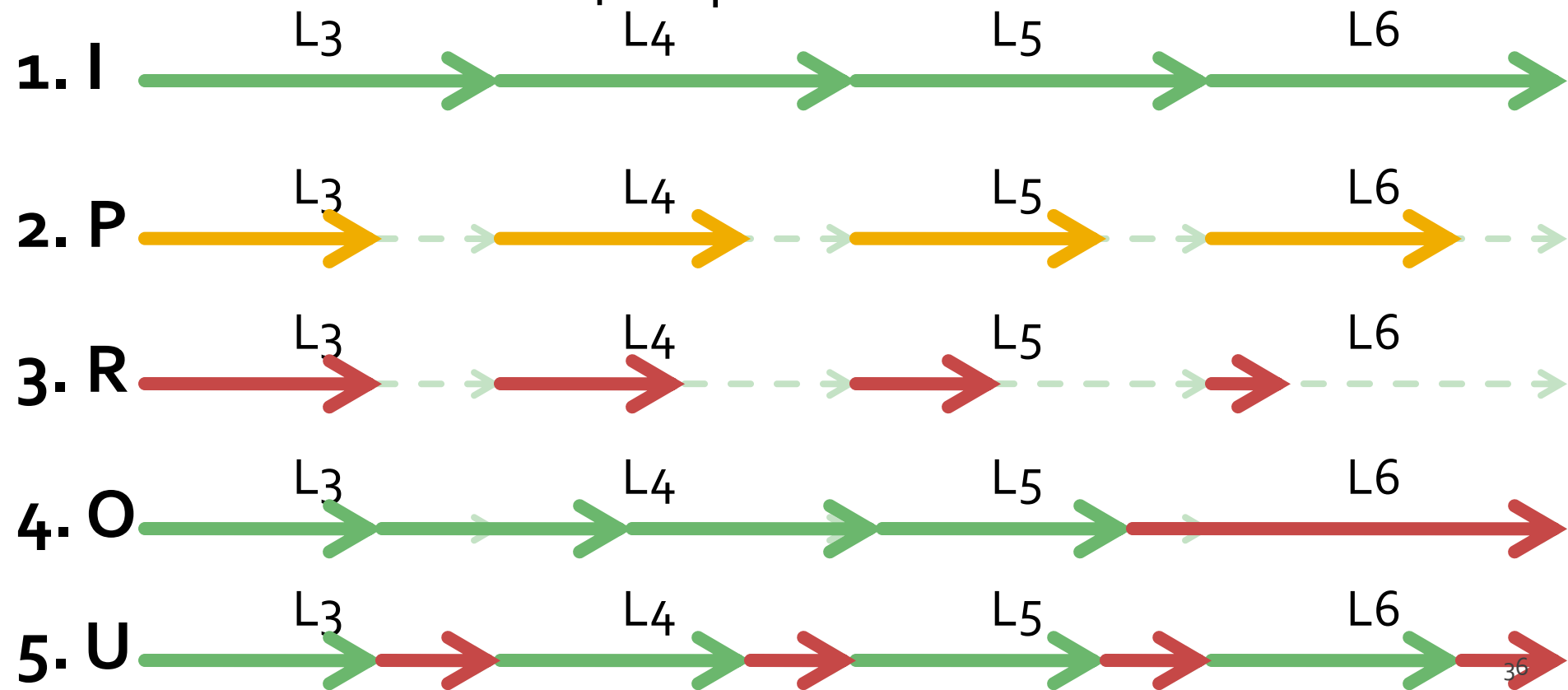

Laborator 5

- Sa se continue magazinul virtual cu:
 - produsele sunt grupate pe **categorii** de produse
 - sa prezinte utilizatorului o lista de categorii de produse pentru a alege
 - sa prezinte utilizatorului o lista de produse si preturi **in categoria** aleasa la pasul anterior
 - lista de produse si preturi se citeste dintr-un **fisier text**
 - se preia comanda si se calculeaza suma totala
- Optional
 - se creaza o pagina prin care vanzatorul poate **modifica** preturile si produsele
 - fisierul care contine date in format **XML**

Laborator – L5 – rezultat

Categorii Produse

Alegeti categoria:

Nr.	Categorie	Total Produse
1	Papetarie	3
2	Instrumente	3
3	Audio-video	3
4	Calculatoare	3
5	Jucarii	2

Total produse: 14

Magazin online Firma X SRL

Realizati comanda

Nr.	Produs	Pret	Cantitate
1	Carti	100	<input type="text" value="1"/>
2	Caiete	50	<input type="text" value="2"/>
3	Penare	150	<input type="text" value="1"/>
4	Stilouri	125	<input type="text" value="0"/>
5	Creioane	25	<input type="text" value="0"/>

Trimite

Magazin online Firma X SRL

Rezultate comanda

Pret total (fara TVA): 350

Pret total (cu TVA): 416.5

Comanda receptionata la data: 17/03/2010 ora 08:24

Laborator 6

Laborator 6

- Sa se continue magazinul virtual cu:
 - produsele sunt grupate pe categorii de produse
 - sa prezinte utilizatorului o lista de categorii de produse pentru a alege
 - sa prezinte utilizatorului o lista de produse si preturi in categoria aleasa
 - lista de produse si preturi se citeste dintr-o baza de date **MySQL**
 - se preia comanda si se calculeaza suma totala
 - **se creaza paginile prin care vanzatorul poate modifica preturile, produsele, categoriile**

Rezultat (comparator)

Categorii Produse

Alegeti categoria:

Nr.	Categorie	Total Produse
1	Papetarie	3
2	Instrumente	3
3	Audio-video	3
4	Calculatoare	3
5	Jucarii	2

Total produse: 14

Magazin online Firma X SRL

Finalizati comanda

Nr.	Produs	Pret	Cantitate
1	Carti	100	<input type="text" value="1"/>
2	Caiete	50	<input type="text" value="2"/>
3	Penare	150	<input type="text" value="1"/>
4	Stilouri	125	<input type="text" value="0"/>
5	Creioane	25	<input type="text" value="0"/>

Magazin online Firma X SRL

Rezultate comanda

Pret total (fara TVA): 350

Pret total (cu TVA): 416.5

Comanda receptionata la data: 17/03/2010 ora 08:24

 post
 get

Rezultat (vanzator)

Magazin Firma X

[Inceput](#) | [Inapoi](#)

Magazin online Firma X SRL

Alegeti:

- [Cumparator](#)
- [Vanzator](#)

Categorii Produse

Alegeti categoria:

Nr.	Categorie	Total Produse
1	Papetarie	3
2	Instrumente	3
3	Audio-video	3
4	Calculatoare	3
5	Jucarii	2

Total produse: 14

Categorie noua de produse:

Lista produse in categoria Calculatoare

Nr.	Produs	Descriere	Pret	Cantitate	Actiuni
1	Laptop	calculator mic	2000	2	modifica
2	Desktop	calculator mare	1000	5	modifica
3	Imprimanta	prn	200	2	modifica
-	Produs nou				adauga

Produs in categoria Calculatoare

Produs	<input type="text" value="laptop"/>
Descriere	<input type="text" value="calculator mic"/>
Pret	<input type="text" value="2000"/>
Cantitate	<input type="text" value="2"/>



Plan aplicatie (Proiect !!)

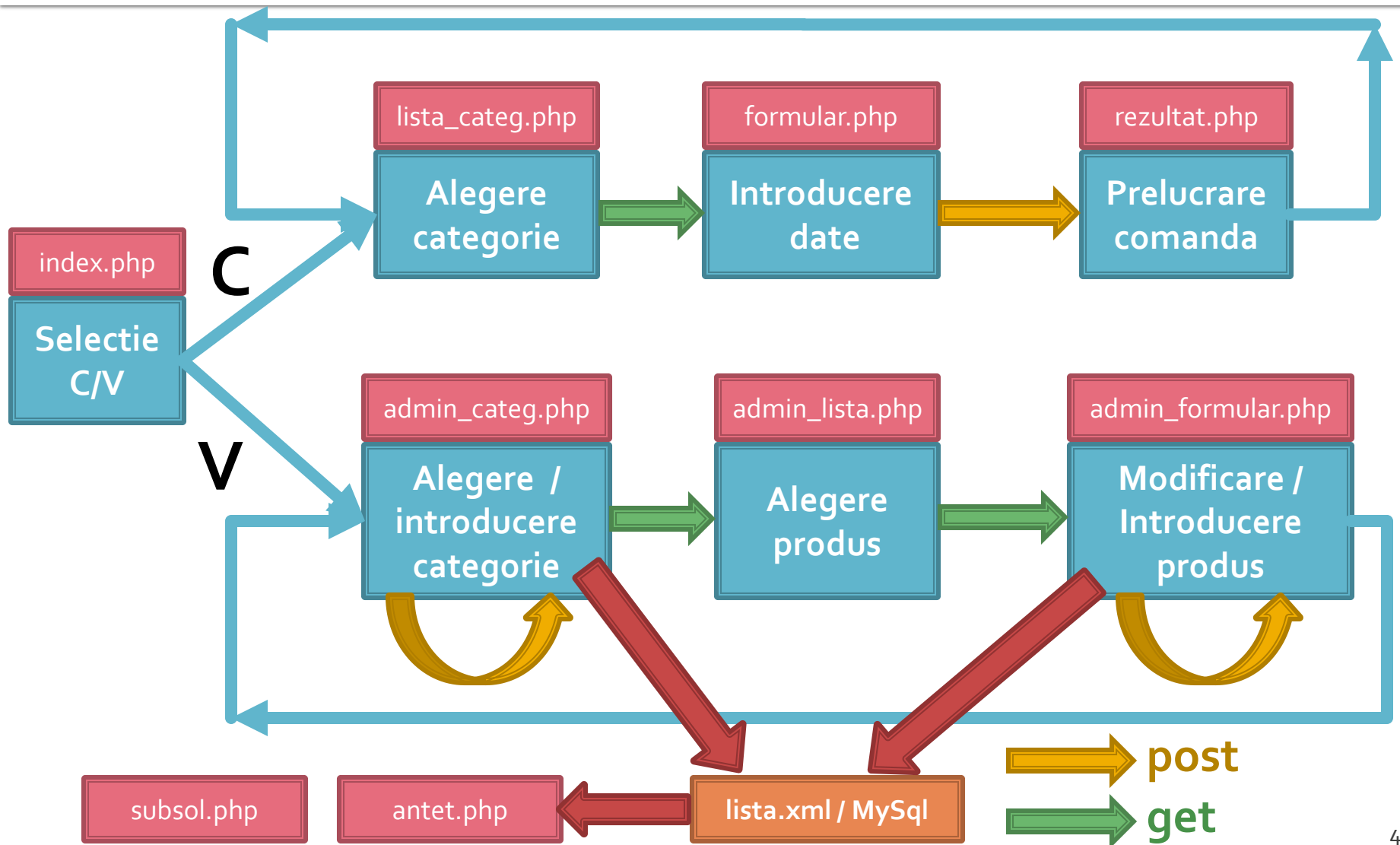

MySql

Accesul la metode externe de stocare eficiente a datelor

MySql

- Baza de date – instrument pentru stocarea si manipularea informatiei eficient si efectiv
 - datele sunt protejate de corupere sau pierderi accidentale
 - nu se utilizeaza mai multe resurse decat minimul necesar
 - datele pot fi accesate cu performanta acceptabila
- Baze de date relationale
 - model relational (matematic eficient) – Codd ~1970

DBMS, RDBMS

- DBMS – database management system aplicatii incluse in baza de date pentru accesul la informatii
- RDBMS – Relational DBMS. Majoritatea sistemelor de baze de date tind la aceasta titulatura
 - ~300 de reguli trebuie respectate
 - nici un sistem actual nu implementeaza total aceste reguli

Relatii

- Toate sistemele de baze de date sunt caracterizate de:
 - toate informatiile sunt reprezentate intr-o aranjare ordonata **bidimensionala** numita **relatie**
 - toate valorile (attribute) stocate sunt scalare (in orice celula din tabel se stocheaza **o singura** valoare)
 - toate operatiile se aplica asupra unei intregi relatii si rezulta o intreaga relatie
- Terminologii (**MySql**)
 - tabel – **table** / recordset / **result set**
 - linie – record / **row**
 - coloana – field / **column**

Relatii, chei

- toate informatiile sunt reprezentate intr-o aranjare bidimensionala numita relatie
 - aranzarile bidimensionale nu sunt ordonate implicit
 - datele trebuie stocate pentru a implementa o relatie in asa fel incat fiecare linie sa fie unica
- cheie candidata
 - exista cel putin o combinatie de attribute (coloane) care pot identifica in mod unic o linie
 - aceste combinatii de attribute se numesc chei candidate

Chei

- Din toate combinatiile de coloane care pot fi utilizate pentru identificarea unica a unei linii se alege **macar** una utilizata intern de RDBMS pentru ordonarea datelor – **cheie primara**
 - Celelalte chei candidate devin **chei alternative** si pot fi folosite pentru eficientizarea prelucrarilor (crearea de “index” dupa aceste chei)
- In cazul in care nu exista o combinatie de coloane utilizabila ca si cheie cu utilitate practica se introduce artificial o cheie, cu numere intregi incrementate automat de DBMS (autoincrement)
 - de multe ori este recomandata o astfel de actiune, numerele intregi fiind mult mai usor de controlat, ordonat, cautat decat alte tipuri de date
 - cheile de tip autoincrement nu e **nevoie** sa contina informatie

Normalizare

- Normalizarea asigura:
 - stocarea eficienta a datelor
 - prelucrarea eficienta a datelor
 - integritatea datelor
- Trei nivele de normalizare
- Eliminarea datelor redundante

OrderID	CustomerID	OrderDate	Items	OrderTotal
1	CACTU	1/1/1999	3 Zaanse koeken, 1 Tarte au sucre	\$89.70
2	BSBEV	1/5/1999	4 Mozzarella di Giovanni	\$139.20
3	SUPRD	5/2/1999	3 Ravioli Angelo, 6 Tofu	\$198.06

Eliminarea datelor redundante

Order ID	SalesPerson	Hire Date	Phone	Company Name	Product Name	Quantity
10871	Dodsworth, Anne	15-Nov-1994	452	Bon app'	Alice Mutton	16
10747	Suyama, Michael	17-Oct-1993	428	Piccolo und mehr	Gorgonzola Telino	8
10258	Davolio, Nancy	01-May-1992	5467	Ernst Handel	Chef Anton's Gumbo Mix	65
11007	Callahan, Laura	05-Mar-1994	2344	Princesa Isabel Vinhos	Thüringer Rostbratwurst	10
10421	Callahan, Laura	05-Mar-1994	2344	Que Delicia	Perth Pasties	15
10558	Davolio, Nancy	01-May-1992	5467	Around the Horn	Perth Pasties	18
10431	Peacock, Margaret	03-May-1993	5176	Bottom-Dollar Markets	Alice Mutton	50
10659	King, Robert	02-Jan-1994	465	Queen Cozinha	Gorgonzola Telino	20
10273	Leverling, Janet	01-Apr-1992	3355	QUICK-Stop	Gorgonzola Telino	15
10382	Peacock, Margaret	03-May-1993	5176	Ernst Handel	Chef Anton's Gumbo Mix	32
10949	Fuller, Andrew	14-Aug-1992	3457	Bottom-Dollar Markets	Alice Mutton	6
10285	Davolio, Nancy	01-May-1992	5467	QUICK-Stop	Perth Pasties	36
10867	Suyama, Michael	17-Oct-1993	428	Lonesome Pine Restaut	Perth Pasties	3
10691	Fuller, Andrew	14-Aug-1992	3457	QUICK-Stop	Thüringer Rostbratwurst	40
10354	Callahan, Laura	05-Mar-1994	2344	Pericles Comidas clásic	Thüringer Rostbratwurst	4
10698	Peacock, Margaret	03-May-1993	5176	Ernst Handel	Thüringer Rostbratwurst	12
10962	Callahan, Laura	05-Mar-1994	2344	QUICK-Stop	Perth Pasties	20
10465	Davolio, Nancy	01-May-1992	5467	Vaffeljernet	Thüringer Rostbratwurst	18
10549	Buchanan, Steven	17-Oct-1993	3453	QUICK-Stop	Gorgonzola Telino	55

Eliminarea datelor redundante

Customers Relation

Customer ID	Company Name	Phone
ALFKI	Alfreds Futterkiste	030-0074321
ANATR	Ana Trujillo Emparedados y helados	(5) 555-4729
ANTON	Antonio Moreno Taquería	(5) 555-3932
AROUT	Around the Horn	(171) 555-7788
BERGS	Berglunds snabbköp	0921-12 34 65
BLAUS	Blauer See Delikatessen	0621-08460
BLONP	Blondel père et fils	88.60.15.31
BOLID	Bólido Comidas preparadas	(91) 555 22 82
BONAP	Bon app'	91.24.45.40
BOTTM	Bottom-Dollar Markets	(604) 555-4729
BSBEV	B's Beverages	(171) 555-1212
CACTU	Cactus Comidas para llevar	(1) 135-5555
CENTC	Centro comercial Moctezuma	(5) 555-3392

Invoices Relation

Order ID	Company Name	Phone
10643	Alfreds Futterkiste	030-0074321
10692	Alfreds Futterkiste	030-0074321
10702	Alfreds Futterkiste	030-0074321
10835	Alfreds Futterkiste	030-0074321
10952	Alfreds Futterkiste	030-0074321
11011	Alfreds Futterkiste	030-0074321
10308	Ana Trujillo Emparedados y helados	(5) 555-4729
10625	Ana Trujillo Emparedados y helados	(5) 555-4729
10759	Ana Trujillo Emparedados y helados	(5) 555-4729
10926	Ana Trujillo Emparedados y helados	(5) 555-4729
10365	Antonio Moreno Taquería	(5) 555-3932
10507	Antonio Moreno Taquería	(5) 555-3932
10535	Antonio Moreno Taquería	(5) 555-3932
10573	Antonio Moreno Taquería	(5) 555-3932
10677	Antonio Moreno Taquería	(5) 555-3932

When was she hired?

Order ID	SalesPerson	Hire Date	Phone	Company Name	Product Name
10871	Dodsworth, Anne	15-Nov-1994	452	Bon app'	Alice Mutton
10747	Suyama, Michael	17-Oct-1993	428	Piccolo und mehr	Gorgonzola Telino
10258	Davolio, Nancy	01-May-1992	5467	Ernst Handel	Chef Anton's Gumbo Mix
11007	Callahan, Laura	05-Mar-1994	2344	Princesa Isabel Vinhos	Thüringer Rostbratwurst
10421	Callahan, Laura	05-Mar-1994	2344	Gue Delicia	Perth Pasties
10558	Davolio, Nancy	01-May-1992	5467	Around the Horn	Perth Pasties
10431	Peacock, Margaret	03-May-1993	5176	Bottom-Dollar Markets	Alice Mutton

Product ID	Product Name	Unit Price
1	Chai	\$18.00
2	Chang	\$19.00
3	Aniseed Syrup	\$10.00
4	Chef Anton's Cajun Seasoning	\$22.00
5	Chef Anton's Gumbo Mix	\$21.35
6	Grandma's Boysenberry Spread	\$25.00
7	Uncle Bob's Organic Dried Pears	\$30.00
8	Northwoods Cranberry Sauce	\$40.00
9	Mishi Kobe Niku	\$97.00
10	Ikura	\$31.00
11	Queso Cabrales	\$21.00
12	Queso Manchego La Pastora	\$38.00
13	Konbu	\$6.00
14	Tofu	\$23.25

These are not the same value

Order ID	Product Name	Unit Price	Quantity	Unit Price
10248	Mozzarella di Giovanni	\$34.80	5	\$174.00
10248	Queso Cabrales	\$21.00	12	\$168.00
10248	Singaporean Hokkien Fried Mee	\$14.00	10	\$98.00
10249	Manjimup Dried Apples	\$53.00	40	\$1,696.00
10249	Tofu	\$23.25	9	\$167.40

Prima forma normala

- toate valorile sunt scalare

OrderID	CustomerID	OrderDate	Items	OrderTotal
1	CACTU	1/1/1999	3 Zaanse koeken, 1 Tarte au sucre	\$89.70
2	BSBEV	1/5/1999	4 Mozzarella di Giovanni	\$139.20
3	SUPRD	5/2/1999	3 Ravioli Angelo, 6 Tofu	\$198.06

- nu toate rezolvarile sunt eficiente

OrderID	CustomerID	Item1	Qty1	Item2	Qty2	Item3	Qty3
1	ANTON	Queso Cabrales	4	Tofu	3	Ravioli Angelo	1
2	BLAUS	Chai	2		0		

Product	Year	TargetJan	ActualJan	TargetFeb	ActualFeb
Aniseed Syrup	2004	\$1,000.00	\$1,300.00	\$0.00	\$0.00
Chai	2004	\$4,000.00	\$2,000.00	\$0.00	\$0.00
Chang	2004	\$3,000.00	\$8,022.00	\$0.00	\$0.00

A doua forma normala

- O relatie este in a **doua** forma normala cand este in **prima** forma normala si suplimentar attributele (valorile de pe coloana) depind de **intreaga cheie** candidata aleasa

 Product Name	 SupplierName	Category Name	SupplierPhoneNumber	
Chai	Exotic Liquids	Beverages	(171) 555-2222	
Chang	Exotic Liquids	Beverages	(171) 555-2222	
Guaraná Fantástica	Refrescos Americanas LTDA	Beverages	(11) 555 4640	
Sasquatch Ale	Bigfoot Breweries	Beverages	(503) 555-9931	
Steeleye Stout	Bigfoot Breweries	Beverages	(503) 555-9931	
Côte de Blaye	Aux joyeux ecclésiastiques	Beverages	(1) 03.83.00.68	
Chartreuse verte	Aux joyeux ecclésiastiques	Beverages	(1) 03.83.00.68	
Ipoh Coffee	Leka Trading	Beverages	555-8787	
Laughing Lumberjack Lager	Bigfoot Breweries	Beverages	(503) 555-9931	
Outback Lager	Paylova, Ltd.	Beverages	(03) 444-2343	

A doua forma normala

Product ID	Product Name	Category
1	Chai	Beverages
2	Chang	Beverages
3	Aniseed Syrup	Condiments
4	Chef Anton's Cajun Seasoning	Condiments
5	Chef Anton's Gumbo Mix	Condiments
6	Grandma's Boysenberry Spread	Condiments
7	Uncle Bob's Organic Dried Pears	Produce

Supplier ID	SupplierName	SupplierPhoneNumber
1	Exotic Liquids	(171) 555-2222
2	New Orleans Cajun Delights	(100) 555-4822
3	Grandma Kelly's Homestead	(313) 555-5735
4	Tokyo Traders	(03) 3555-5011
5	Cooperativa de Quesos 'Las Cabras'	(98) 598 76 54
6	Mayumi's	(06) 431-7877
7	Pavlova, Ltd.	(03) 444-2343
8	Specialty Biscuits, Ltd.	(161) 555-4448
9	PB Knäckebröd AB	031-987 65 43

A treia forma normala

- O relatie este in a **treia** forma normala cand este in a **doua** forma normala si suplimentar attributele (valorile de pe coloana) care nu fac parte din cheie sunt **mutual independente**

	 Company Name	Address	City 	Region 	Postal Code 
	Exotic Liquids	49 Gilbert St.	London		EC1 4SD
	New Orleans Cajun Delights	P.O. Box 78934	New Orleans	LA	70117
	Grandma Kelly's Homestead	707 Oxford Rd.	Ann Arbor	MI	48104
	Tokyo Traders	9-8 Sekimai	Tokyo		100
	Cooperativa de Quesos 'Las Cabras'	Calle del Rosal 4	Oviedo	Asturias	33007
	Mayumi's	92 Setsuko	Osaka		545
	Pavlova, Ltd.	74 Rose St.	Melbourne	Victoria	3058

A treia forma normala

Company Name	Address	City
Exotic Liquids	49 Gilbert St.	London
New Orleans Cajun Delights	P.O. Box 78934	New Orleans
Grandma Kelly's Homestead	707 Oxford Rd.	Ann Arbor
Tokyo Traders	9-8 Sekimai	Tokyo
Cooperativa de Quesos 'Las Cabras'	Calle del Rosal 4	Oviedo
Mayumi's	92 Setsuko	Osaka
Pavlova, Ltd.	74 Rose St.	Melbourne

City	Region	Postal Code
Melbourne	Victoria	3058
Ste-Hyacinthe	Québec	J2S 7S8
Montréal	Québec	H1J 1C3
Bend	OR	97101
Sydney	NSW	2042
Ann Arbor	MI	48104
Boston	MA	02134
New Orleans	LA	70117
Oviedo	Asturias	33007

Normalizare suplimentara

- Se tine cont si de eliminarea datelor redundante. Anumite redundante pot fi eliminate prin introducerea de relatii suplimentare
- Forma normala Boyce/Codd cere sa nu existe dependenta functionala intre cheile candidate



Supplier ID	SupplierName	Product	Quantity	Unit Price
5	Cooperativa de Quesos 'Las Cabras'	Queso Cabrales	12	\$14.00
20	Leka Trading	Singaporean Hokkien Fried Mee	10	\$9.80
14	Formaggi Fortini s.r.l.	Mozzarella di Giovanni	5	\$34.80
24	G'day, Mate	Manjimup Dried Apples	40	\$42.40
6	Mayumi's	Tofu	9	\$18.60
24	G'day, Mate	Manjimup Dried Apples	35	\$42.40
19	New England Seafood Cannery	Jack's New England Clam Chowder	10	\$7.70
2	New Orleans Cajun Delights	Louisiana Fiery Hot Pepper Sauce	15	\$16.80

Normalizare suplimentara

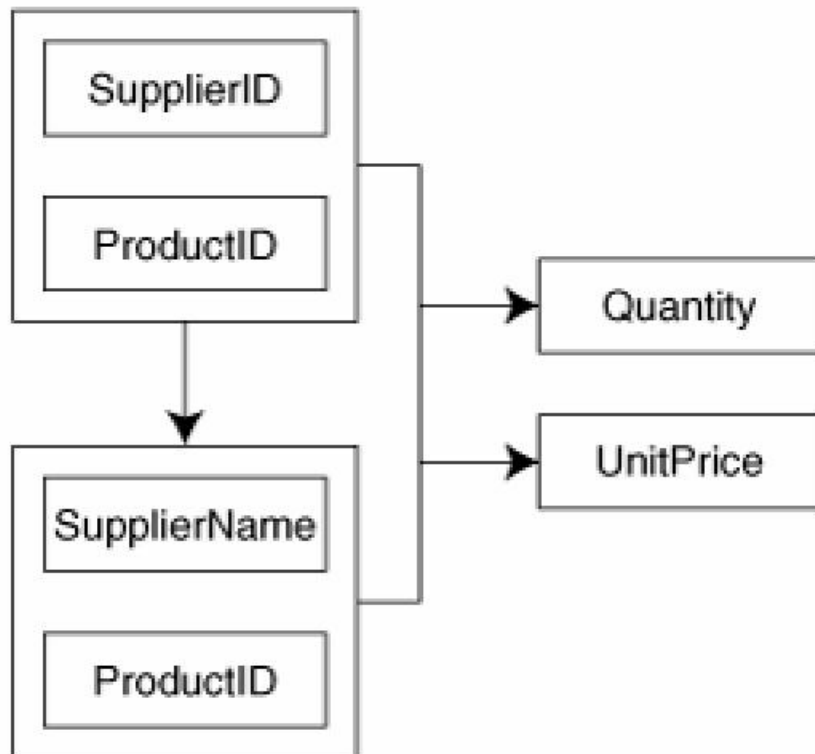

Supplier ID	SupplierName
1	Exotic Liquids
2	New Orleans Cajun Delights
3	Grandma Kelly's Homestead
4	Tokyo Traders
5	Cooperativa de Quesos 'Las Cabras'
6	Mayumi's

SupplierID	ProductID	Quantity	UnitPrice
2	65	15	\$21.05
24	53	15	\$32.80
8	20	40	\$81.00
22	47	16	\$9.50
6	14	9	\$23.25
28	59	30	\$55.00
28	60	40	\$34.00
21	46	15	\$12.00

MySql

Relatii in Bazele de date

Relatii in Bazele de date

- Legaturile intre tabele pot fi
 - One to One
 - One to Many
 - Many to Many
 - Unare (auto referinta)

One to One

- Fiecare tabel poate avea corespondenta **o singura linie (row) sau nici una** de cealalta parte a relatiei
- echivalent cu o relatie “bijectiva”
- analogie cu casatorie:
 - o persoana poate fi casatorita sau nu
 - daca este casatorita va fi casatorita cu o singura persoana din tabelul cu persoane de sex opus
 - persoana respectiva va fi caracterizata de aceeasi relatie “one to one” – primeste simultan un singur corespondent in tabelul initial

One to One

- de multe ori legaturile "one to one" se bazeaza pe reguli externe
- de obicei se poate realiza usor si eficient gruparea ambelor tabele in unul singur

CUSTOMERS		
customer_id	customer_name	address_id
101	John Doe	301
102	Bruce Wayne	302

ADDRESSES	
address_id	address
301	12 Main St., Houston TX 77001
302	1007 Mountain Dr., Gotham NY 10286

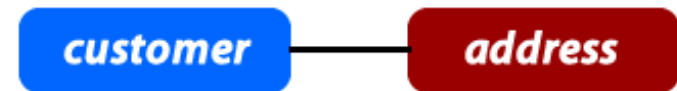
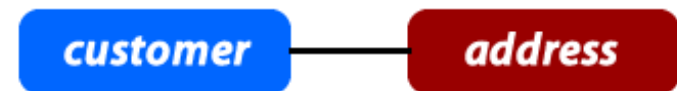

CUSTOMERS		
customer_id	customer_name	customer_address
101	John Doe	12 Main St., Houston TX 77001
102	Bruce Wayne	1007 Mountain Dr., Gotham NY 10286

One to Many

- O linie dintr-un tabel (row), identificata prin cheia primara, poate avea: **nici una, una sau mai multe linii corespondente** in celalalt tabel. In acesta o linie poate fi legata cu o **singura** linie din tabelul primar.
- Analogie cu relatii parinte/copil:
 - fiecare om are o singura mama
 - fiecare femeie poate avea nici unul, unul sau mai multi copii

One to Many, Many to One

- de obicei aceste legaturi se implementeaza prin introducerea cheii primare din tabelul **One** in calitate de coloana in tabelul **Many** (cheie externa – foreign key)

↓

CUSTOMERS	
customer_id	customer_name
101	John Doe
102	Bruce Wayne

↓

ORDERS			
order_id	customer_id	order_date	amount
555	101	12/24/09	\$156.78
556	102	12/25/09	\$99.99
557	101	12/26/09	\$75.00

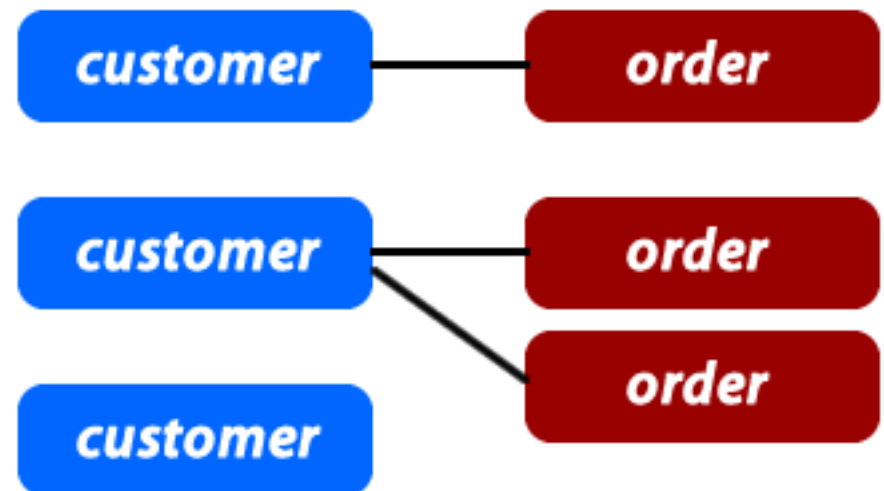

Many to Many

- Fiecare linie (row) din **ambele tabele** implicate in legatura poate fi legat cu **oricate (niciuna, una sau mai multe) linii** din tabelul corespondent.
- Analogie cu relatii de rudenie (veri de exemplu), tabel 1 – barbati, tabel 2 – femei :
 - fiecare barbat poate fi ruda cu una sau mai multe femei
 - la randul ei fiecare femeie poate fi ruda cu unul sau mai multi barbati

Many to Many

- de obicei aceste legaturi se implementeaza prin introducerea unui tabel **suplimentar** (numit tabel **asociat** sau de **legatura**) care sa memoreze legaturile

ORDERS				
order_id	customer_id	order_date	amount	
555	101	12/24/09	\$156.78	
556	102	12/25/09	\$99.99	

ITEMS		
item_id	item_name	item_description
201	Tickle Me Elmo	It wants to be tickled
202	District 9 DVD	Awesome sci-fi movie
203	Batarang	It is very sharp

ITEMS_ORDERS	
order_id	item_id
555	201
555	202
556	202
556	203

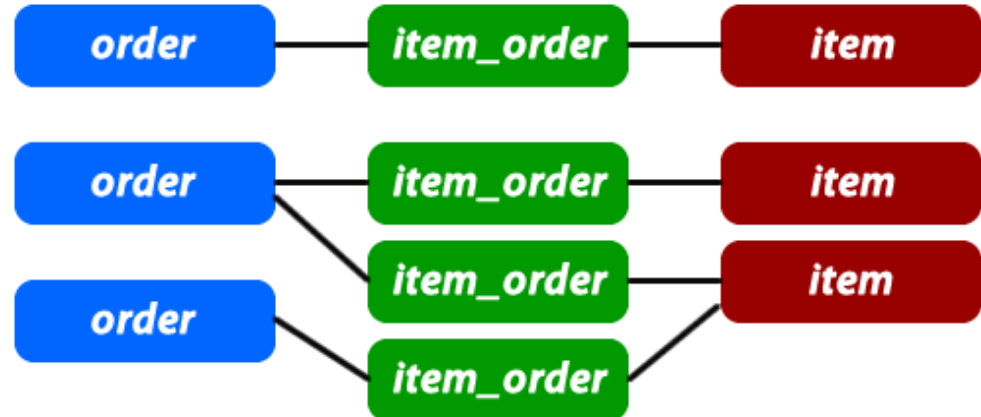

Self Referencing (unare)

- Un caz particular de legatura "one to many" in care legatura e in interiorul aceluiasi tabel
- rezolvarea este similara, introducerea unei coloane suplimentara, cu referinta la cheia primara din tabel
- analogie cu relatii parinte copil cand ambele persoane se regasesc in acelasi tabel

CUSTOMERS		
customer_id	customer_name	referrer_customer_id
101	John Doe	0
102	Bruce Wayne	101
103	James Smith	101

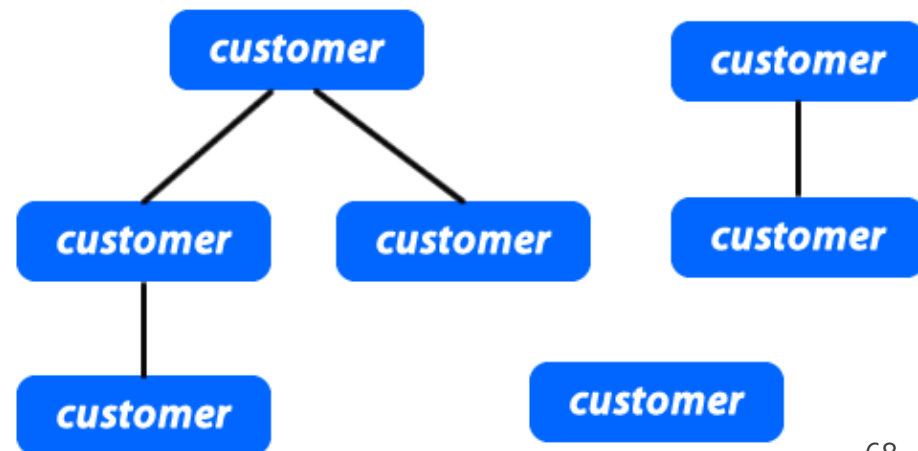

Relatii in Bazele de date

- Respectarea formelor normale ale bazelor de date aduce nenumarate avantaje
- Efectul secundar este dat de necesitatea separarii datelor intre mai multe tabele
- In exemplul utilizat avem doua concepte diferite din punct de vedere logic
 - produs
 - categorie de produs

Relatii in Bazele de date

- In exemplul utilizat avem doua concepte diferite din punct de vedere logic
 - produs
 - categorie de produs
- Cele doua tabele nu sunt independente
- Intre ele exista o legatura data de functionalitatea dorita pentru aplicatie: **un produs va apartine unei anumite categorii de produse**

Relatii in Bazele de date

- Legaturile implementata
 - One to Many
 - in tabelul "produse" apare cheia externa (foreign key): "id_categ"

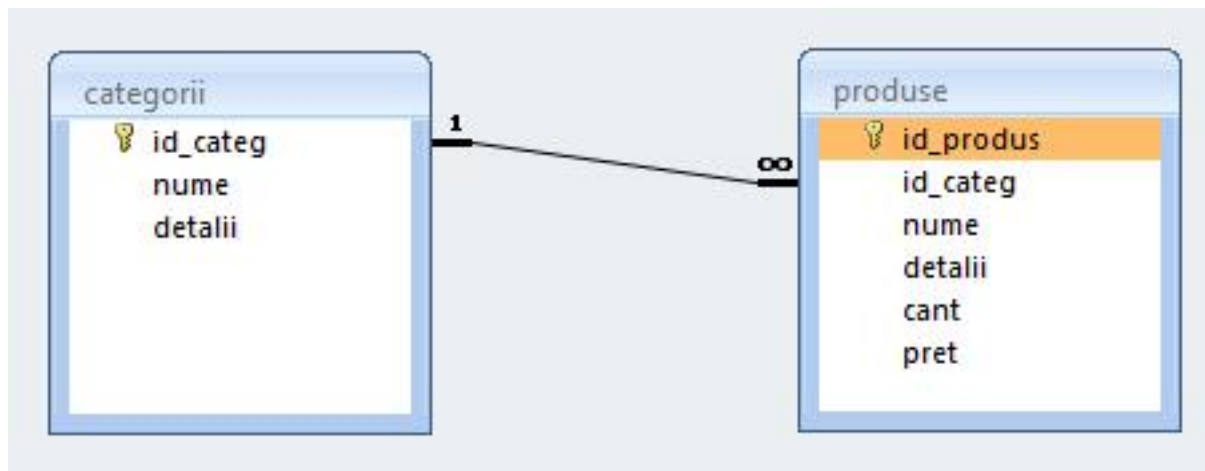

Relatii in Bazele de date

- Daca se doreste o situatie cand un produs poate apartine **mai multor categorii** (o carte cu CD poate fi inclusa si in "papetarie" si in "audio-video")
 - relatia devine de tipul **Many to Many**
 - e necesara introducerea unui tabel de legatura cu coloanele "id_leg" (cheie primara), "id_categorie" si "id_produs" (chei externe)

Relatii in Bazele de date

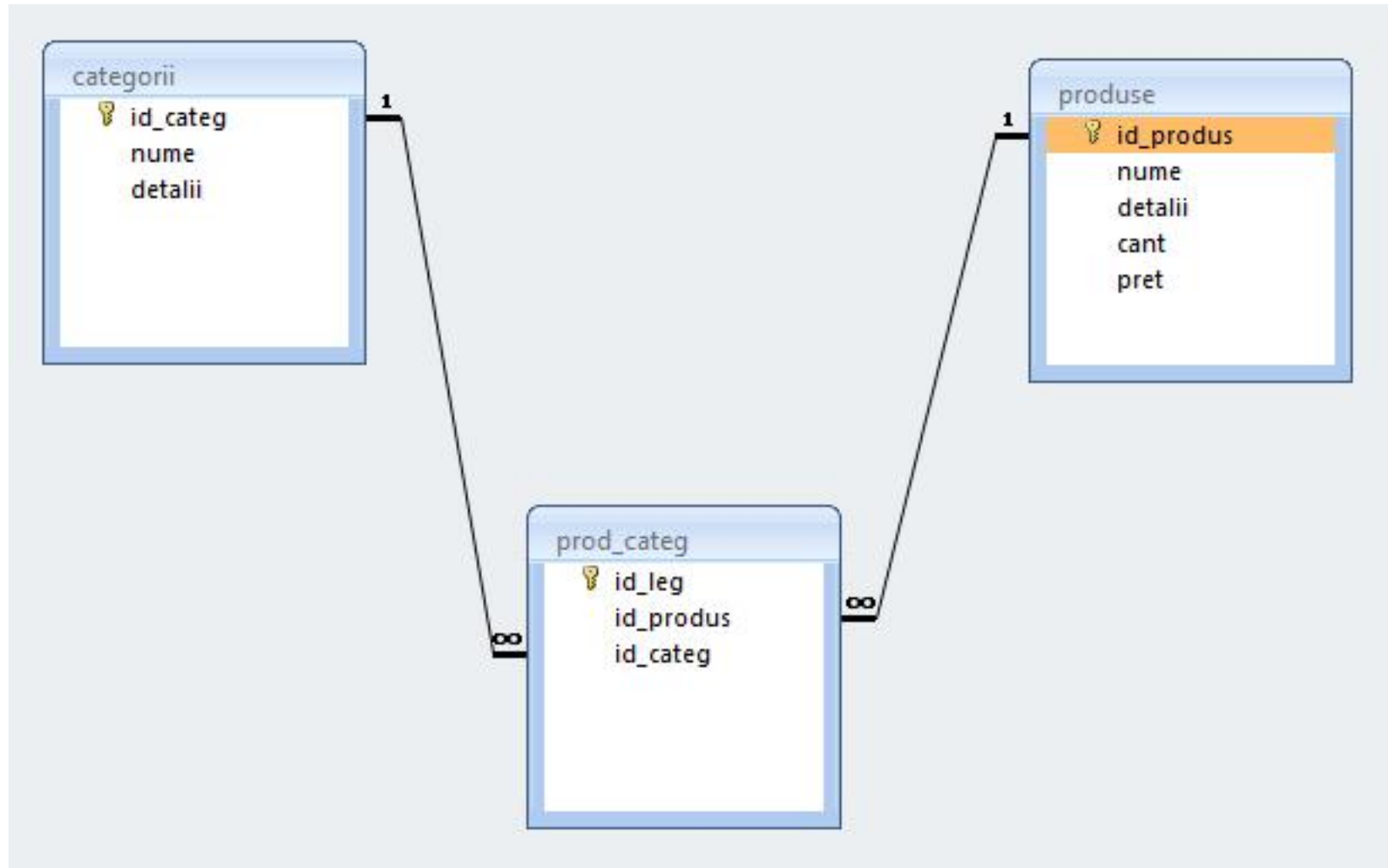

Relatii

- **Nu** trebuie evitate relatiile
 - Many to Many
 - One to Many
- Prelucrarea cade in sarcina server-ului de baze de date (**RDBMS**)
 - JOIN – **esential** in aplicatii cu baze de date

MySQL – eficienta

- eficienta unei aplicatii web
 - 100% - **toate prelucrarile "mutate" in RDBMS**
 - PHP **doar** afisarea datelor
- eficienta unei aplicatii MySQL
 - 25% **alegerea corecta a tipurilor de date**
 - 25% **crearea indecsilor necesari in aplicatii**
 - 25% **normalizarea corecta a bazei de date**
 - 20% **cresterea complexitatii interogarilor pentru a "muta" prelucrarile pe server-ul de baze de date**
 - 5% **scrierea corecta a interogarilor**

MySql

Tipuri de date

MySql – tipuri de date

- numeric
 - intregi
 - BIT (implicit 1 bit)
 - TINYINT (implicit 8 biti)
 - SMALLINT (implicit 16 biti)
 - INTEGER (implicit 32biti)
 - BIGINT (implicit 64biti)
 - real
 - FLOAT
 - DOUBLE
 - DECIMAL – fixed point

MySql – tipuri de date

- data/timp
 - DATE ('YYYY-MM-DD')
 - '1000-01-01' pana la '9999-12-31'
 - DATETIME ('YYYY-MM-DD HH:MM:SS')
 - '1000-01-01 00:00:00' pana la '9999-12-31 23:59:59'
 - TIMESTAMP ('YYYY-MM-DD HH:MM:SS')
 - '1970-01-01 00:00:00' pana la partial 2037

MySQL – tipuri de date

- sir
 - CHAR (M)
 - sir de lungime constanta M, $M < 255$
 - VARCHAR (M)
 - sir de lungime variabila, maxim M, $M < 255$ ($M < 65535$)
- cantitati mari de date
 - TEXT
 - au alocat un set de caractere, operatiile tin cont de acesta
 - BLOB
 - sir de octeti, operatiile tin cont de valoarea numerica
 - TINYBLOB/TINYTEXT, BLOB/TEXT, MEDIUMBLOB/MEDIUMTEXT, LARGEBLOB/LARGETEXT
 - date 2^8-1 , $2^{16}-1$, $2^{24}-1$, $2^{32}-1 = 4\text{GB}$

MySQL – tipuri de date

- enumerare

- ENUM('val₁', 'val₂', ...)

- una singura din cele maxim 65535 valori distincte posibile

- SET('val₁', 'val₂', ...)

- niciuna sau mai multe din cele maxim 64 valori distincte
- echivalent cu "setare de biti" într-un întreg pe 64 biti cu tabela asociată

Metode de stocare

Metode de stocare

- Metoda de stocare a datelor nu e o caracteristica a server-ului ci a fiecarui tabel in parte
- Exemplu ulterior CREATE: "ENGINE = InnoDB"
- MySql suporta diferite metode de stocare, fiecare cu avantajele/dezavantajele sale
- Implicit se foloseste metoda MyISAM, dar la instalarea server-ului (laborator 1) o anumita selectie poate schimba valoarea implicita in InnoDB
- **Alegerea metodei de stocare potrivita are implicatii majore asupra performantei aplicatiei**

Metode de stocare

- MyISAM
- InnoDB
- Memory
- Merge
- Archive
- Federated
- NDBCLUSTER
- CSV
- Blackhole
- Example

Metode de stocare

■ MyISAM

- metoda de stocare implicita in MySql (<5.5)
- performanta ridicata (resurse ocupate si viteza)
- posibilitatea cautarii in intregul text (index FULLTEXT)
- blocare acces la nivel de tabel
- nu accepta tranzactii
- nu accepta FOREIGN KEY
 - probleme relative la integritatea datelor

■ InnoDB

■ Memory

Metode de stocare

- **MyISAM**
- **InnoDB**
 - devine metoda de stocare implicita in MySql daca la instalare se alege model tranzactional (**sau >5.5**)
 - performanta medie (resurse ocupate si viteza)
 - blocare acces la nivel de linie
 - **nu** accepta index FULLTEXT
 - incepand cu MySql 5.6.4 este introdus index FULLTEXT
 - **accepta** tranzactii
 - **accepta** FOREIGN KEY
 - probleme mai putine la integritatea datelor prin constrangeri intre tabele
- **Memory**

Metode de stocare

- MyISAM
- InnoDB
- **Memory**
 - metoda de stocare recomandata pentru tabele temporare
 - performanta maxima (viteza – datele sunt stocate in RAM)
 - **la oprirea server-ului datele se pierde**, tabelul este pastrat dar va fi fara nici o linie
 - **nu** accepta tipuri de date mari (BLOB, TEXT) – maxim 255 octeti
 - **nu** accepta index FULLTEXT
 - **nu** accepta tranzactii
 - **nu** accepta FOREIGN KEY
 - probleme relative la integritatea datelor

Limbas SQL

Referinta relativa

- Referinta la elementele unei baze de date se face prin utilizarea numelui elementului respectiv daca nu exista dubii (referinta relativa)
 - daca baza de date este selectata se poate utiliza numele tabelului pentru a identifica un tabel
 - `USE db_name;`
`SELECT * FROM tbl_name;`
 - daca tabelul este identificat in instructiune se poate utiliza numele coloanei pentru a identifica coloana implicata
 - `SELECT col_name FROM tbl_name;`

Referinta absoluta

- In cazul in care apare ambiguitate in identificarea unui element se poate indica descendenta sa pâna la disparitia ambiguitatii
- Astfel, o anumita coloana, `col_name`, care apartine tabelului `tbl_name` din baza de date (schema) `db_name` poate fi identificata in functie de necesitati ca:
 - `col_name`
 - `tbl_name.col_name`
 - `db_name.tbl_name.col_name`

Nume de identificatori permise

- Numele de identificatori pot avea o lungime de reprezentare de maxim 64 octeti cu excepția Alias care poate avea o lungime de 255 octeti
- Nu sunt permise:
 - caracterul NULL (ASCII 0x00) sau 255 (0xFF)
 - caracterul "/"
 - caracterul "\"
 - caracterul "."
- Numele nu se pot termina cu caracterul spațiu

Nume de identificatori permise

- Numele de baze de date nu pot contine decat caractere permise in numele de directoare
- Numele de tabele nu pot contine decat caractere permise in numele de fisiere
- Anumite caractere utilizate vor impune necesitatea trecerii intre apostroafe a numelui
- Apostroful utilizat pentru nume de identificatori e apostroful invers (**backtick**) “`”
 - pentru a nu aparea confuzie cu variabilele sir
 - nu necesita aparitia apostrofului caracterele alfanumerice normale, “_”, “\$”
- numele rezervate trebuie de asemenea cuprinse intre apostroafe pentru a fi utilizate

Alias

- Orice identificator poate primi un nume asociat
 - **Alias**
 - pentru a elimina ambiguitati
 - pentru a usura scrierea
 - pentru a modifica numele coloanelor in rezultate
- Definirea unui alias se face in interiorul unei interogari SQL si are efect in aceeasi interogare
 - `SELECT `t`.* FROM `tbl_name` AS t;`
 - `SELECT `t`.* FROM `tbl_name` t;`

Alias

- Desi utilizarea cuvintului cheie AS nu este obligatorie, obisnuinta utilizarii lui este recomandata, pentru a evita/identifica alocari eronate
 - `SELECT id, nume FROM produse;` ← doua coloane
 - `SELECT id nume FROM produse;` ← Alias "nume" creat pentru coloana "id"

Alias

- Usurinta scrierii
 - `SELECT * FROM un_tabel_cu_nume_lung AS t WHERE t.col1 = 5 AND t.col2 = 'ceva'`
- Modificarea numelui de coloana, sau crearea unui nume pentru o coloana calculata in rezultate
 - `SELECT CONCAT(nume, ' ', prenume) AS nume_intreg FROM studenti AS s;`
 - `SELECT `n1` AS `Nume`, `n2` AS `Nota`, `n3` AS `Numar matricol` FROM elevi AS e;`

Alias

- Eliminarea ambiguitatilor
 - intalnita frecvent la relatii "many to many"
 - `SELECT p.*, c.`nume` AS `nume_categ` FROM `produse` AS p LEFT JOIN `categorii` AS c ON (c.`id_categ` = p.`id_categ`)"`;
 - tabelele c si p contin ambele coloanele "nume" si "id_categ"
 - modificarea denumirii coloanei "nume" din categorii pentru evitarea confuziei cu coloana "nume" din produse
 - eventual se pot da nume diferite coloanelor "id_categ" pentru a evita ambiguitatea in interiorul clauzei ON (desi si referinta absoluta rezolva aceasta problema)

Interrogari SQL

Interogari

- Interogariile SQL pot fi
 - Pentru definirea datelor, crearea programatica de baze de date, tabele, coloane etc.
 - mai putin utilizate in majoritatea aplicatiilor
 - ALTER, CREATE, DROP, RENAME
 - Pentru manipularea datelor
 - SELECT, INSERT, UPDATE, REPLACE etc.
 - Pentru control/administrare tranzactii/server
- De cele mai multe ori aplicatiile doar manipuleaza datele. Structura este definita in avans de asemenea si administrarea este mai facila cu programe specializate
- Urmatoarele definitii sunt cele valabile pentru **MySql 5.0**

ALTER DATABASE

- ALTER {DATABASE | SCHEMA} [db_name] alter_specification ...
 - alter_specification:
 - [DEFAULT] CHARACTER SET [=] charset_name
 - [DEFAULT] COLLATE [=] collation_name
- Modifica caracteristicile generale ale unei baze de date
- E necesar dreptul de acces (privilegiu) ALTER asupra respectivei baze de date

ALTER TABLE

- ALTER TABLE {table_option [, table_option] ... | partitioning_specification}
 - table_option:
 - ADD [COLUMN] col_name column_definition [FIRST | AFTER col_name]
 - ADD {INDEX|KEY} [index_name] [index_type] (index_col_name,...) [index_option] ...
 - ADD [CONSTRAINT [symbol]] PRIMARY KEY [index_type] (index_col_name,...) [index_option]
 - ...
 - CHANGE [COLUMN] old_col_name new_col_name column_definition [FIRST|AFTER col_name]
 - MODIFY [COLUMN] col_name column_definition [FIRST | AFTER col_name]
 - DROP [COLUMN] col_name
 - DROP PRIMARY KEY
 - DROP {INDEX|KEY} index_name
 - DISABLE KEYS
 - ENABLE KEYS
 - RENAME [TO] new_tbl_name
- permite modificarea unui tabel existent

CREATE DATABASE

- CREATE {DATABASE | SCHEMA} [IF NOT EXISTS] db_name [create_specification...]
 - create_specification:
 - [DEFAULT] CHARACTER SET charset_name
 - [DEFAULT] COLLATE collation_name
- Crearea unei noi baze de date
- Necesara la instalarea unei aplicatii
- Fisierile SQL "backup" contin succesiunea DROP..., CREATE... pentru a inlocui datele in intregime

CREATE INDEX

- CREATE [UNIQUE|FULLTEXT|SPATIAL] INDEX index_name [USING index_type] ON tbl_name (index_col_name,...)
 - index_col_name:
 - col_name [(length)] [ASC | DESC]
- Crearea unui index se face de obicei la crearea tabelului
- Interogarea CREATE INDEX ... se transpune in interogare ALTER TABLE ...

CREATE TABLE

- CREATE [TEMPORARY] TABLE [IF NOT EXISTS] tbl_name [(create_definition,...)] [table_options] [select_statement]
- CREATE [TEMPORARY] TABLE [IF NOT EXISTS] tbl_name [() LIKE old_tbl_name ()]
- Interogarea de creare a tabelului este memorata intern de server-ul MySql pentru utilizari ulterioare (in general in ALTER TABLE sa fie cunoscute specificatiile initiale)

CREATE TABLE

- create_definition – coloana impreuna cu eventualele caracteristici (in special chei - indecsi):
 - column_definition
 - | [CONSTRAINT [symbol]] PRIMARY KEY [index_type] (index_col_name,...)
 - | KEY [index_name] [index_type] (index_col_name,...)
 - | INDEX [index_name] [index_type] (index_col_name,...)
 - | [CONSTRAINT [symbol]] UNIQUE [INDEX] [index_name] [index_type] (index_col_name,...)
 - | [FULLTEXT|SPATIAL] [INDEX] [index_name] (index_col_name,...)
 - | [CONSTRAINT [symbol]] FOREIGN KEY [index_name] (index_col_name,...) [reference_definition]
 - | CHECK (expr)
- column_definition – nume si tipul de date (curs 7-8):
 - col_name type [NOT NULL | NULL] [DEFAULT default_value] [AUTO_INCREMENT] [UNIQUE [KEY] | [PRIMARY] KEY] [COMMENT 'string'] [reference_definition]

CREATE TABLE

- Exemple
 - CREATE TABLE test (a INT NOT NULL AUTO_INCREMENT, PRIMARY KEY (a), KEY(b)) SELECT b,c FROM test2;
 - CREATE TABLE IF NOT EXISTS `schema`.`Employee` (
`idEmployee` VARCHAR(45) NOT NULL,
`Name` VARCHAR(255) NULL,
`idAddresses` VARCHAR(45) NULL,
PRIMARY KEY (`idEmployee`),
CONSTRAINT `fkEmployee_Addresses`
FOREIGN KEY `fkEmployee_Addresses` (`idAddresses`)
REFERENCES `schema`.`Addresses` (`idAddresses`)
ON DELETE NO ACTION
ON UPDATE NO ACTION)
ENGINE = InnoDB
DEFAULT CHARACTER SET = utf8
COLLATE = utf8_bin

CREATE TABLE

- `CREATE ... LIKE ...` creaza un tabel fara date pe baza modelului unui tabel existent. Se pastreaza definitiile coloanelor si eventualele chei (index) definite in tabelul anterior
- `CREATE ... SELECT ...` creaza un tabel cu date pe baza modelului si datelor obtinute dintr-un alt tabel existent. Sunt obtinute anumite coloane (`SELECT`) cu tipul lor, dar fara crearea indecsilor
- `CREATE TEMPORARY TABLE` creaza un tabel temporar. Utilizat in cazul interogarilor complexe sau cu numar mare de rezultate

DROP

- DROP {DATABASE | SCHEMA} [IF EXISTS]
db_name
- DROP INDEX index_name ON tbl_name
- DROP [TEMPORARY] TABLE [IF EXISTS]
tbl_name [, tbl_name] ...
- Trebuie utilizate cu foarte mare atentie aceste interogari, stergerea datelor este ireversibila
- Fisierile SQL "backup" contin succesiunea DROP..., CREATE... pentru a inlocui datele in intregime

Interrogari SQL

Interogari

- Interogari SQL pot fi
 - Pentru definirea datelor, crearea programatica de baze de date, tabele, coloane etc.
 - mai putin utilizate in majoritatea aplicatiilor
 - ALTER, CREATE, DROP, RENAME
 - **Pentru manipularea datelor**
 - SELECT, INSERT, UPDATE, REPLACE, DELETE etc.
 - Pentru control/administrare tranzactii/server
- De cele mai multe ori aplicatiile doar manipuleaza datele. Structura este definita in avans de asemenea si administrarea este mai facila cu programe specializate
- Urmatoarele definitii sunt cele valabile pentru **MySql 5.0**

DELETE

- `DELETE [LOW_PRIORITY] [QUICK] [IGNORE]
FROM table_name [WHERE where_condition]
[ORDER BY ...] [LIMIT row_count]`
- Sterge linii din tabelul mentionat si returneaza
numarul de linii sterse
- `[LOW_PRIORITY] [QUICK] [IGNORE]` sunt
optiuni care instruiesc server-ul sa reactioneze
diferit de varianta standard
- Exemplu:
 - `DELETE FROM somelog WHERE user = 'jcole'
ORDER BY timestamp_column LIMIT 1;`

DELETE

- [WHERE where_condition] – folosit pentru a selecta liniile care trebuie sterse
 - In absenta conditiei se sterg **toate liniile** din tabel
- [LIMIT row_count] sterge numai *row_count* linii dupa care se opreste
 - In general pentru a limita ocuparea server-ului (recrearea indecsilor se face “on the fly”)
 - Operatia se poate repeta pana valoarea returnata e mai mica decat row_count
- [ORDER BY ...] precizeaza ordinea in care se sterg liniile identificate prin conditie

INSERT

- INSERT [LOW_PRIORITY | DELAYED | HIGH_PRIORITY] [IGNORE] [INTO] tbl_name [(col_name,...)] VALUES ({expr | DEFAULT},...),(...),... [ON DUPLICATE KEY UPDATE col_name=expr, ...]
- INSERT [LOW_PRIORITY | DELAYED | HIGH_PRIORITY] [IGNORE] [INTO] tbl_name SET col_name={expr | DEFAULT}, ... [ON DUPLICATE KEY UPDATE col_name=expr, ...]
- INSERT [LOW_PRIORITY | HIGH_PRIORITY] [IGNORE] [INTO] tbl_name [(col_name,...)] SELECT ... [ON DUPLICATE KEY UPDATE col_name=expr, ...]

INSERT

- Introduce linii noi intr-un tabel
- Primele doua forme introduc valori exprimate explicit
 - INSERT ... VALUES ...
 - INSERT ... SET ...
- INSERT ... SELECT ... introduce valori rezultate obtinute printr-o interogare SQL
- DELAYED – interogarea primeste raspuns de la server imediat, dar inserarea datelor se face efectiv cand tabelul implicat nu este folosit
 - valabil pentru metodele de stocare MyISAM, Memory, Archive

INSERT

- Exemple
 - `INSERT INTO tbl_name (a,b,c) VALUES (1,2,3), (4,5,6), (7,8,9);`
 - `INSERT INTO tbl_name (col1,col2) VALUES (15,col1*2);`
 - `INSERT INTO table1 (field1,field3,field9) SELECT field3,field1,field4 FROM table2;`

INSERT

- INSERT ... ON DUPLICATE KEY UPDATE ...
- Daca inserarea unei noi linii ar conduce la duplicarea unei chei primare sau unice, in loc sa se introduca o noua linie se modifica linia anterioara
- Exemple
 - INSERT INTO table (a,b,c) VALUES (1,2,3) ON DUPLICATE KEY UPDATE c=c+1;
 - INSERT INTO table (a,b,c) VALUES (1,2,3),(4,5,6) ON DUPLICATE KEY UPDATE c=VALUES(a)+VALUES(b);

REPLACE

- REPLACE [LOW_PRIORITY | DELAYED] [INTO] tbl_name [(col_name,...)] VALUES ({expr | DEFAULT},...),(...),...
- REPLACE [LOW_PRIORITY | DELAYED] [INTO] tbl_name SET col_name={expr | DEFAULT}, ...
- REPLACE [LOW_PRIORITY | DELAYED] [INTO] tbl_name [(col_name,...)] SELECT ...
- REPLACE functioneaza similar cu INSERT
 - daca noua linie nu realizeaza duplicarea unei chei primare sau unice se realizeaza insertie
 - daca noua linie realizeaza duplicarea unei chei primare sau unice se sterge linia anterioara dupa care se insereaza noua linie
- REPLACE e extensie MySql a limbajului SQL standard

UPDATE

- UPDATE [LOW_PRIORITY] [IGNORE] tbl_name SET col_name1=expr1 [, col_name2=expr2 ...] [WHERE where_condition] [ORDER BY ...] [LIMIT row_count]
- Modificarea valorilor stocate intr-o linie
- Exemple
 - UPDATE persondata SET age=15 WHERE id=6;
 - UPDATE persondata SET age=age+1;

SELECT

- SELECT [ALL | DISTINCT | DISTINCTROW]
[HIGH_PRIORITY] [STRAIGHT_JOIN]
select_expr, ... [FROM table_references
 - [WHERE where_condition]
 - [GROUP BY {col_name | expr | position} [ASC | DESC],
... [WITH ROLLUP]]
 - [HAVING where_condition]
 - [ORDER BY {col_name | expr | position} [ASC | DESC],
...]
 - [LIMIT {[offset,] row_count | row_count OFFSET
offset}]
-]

SELECT

- SELECT este **cea mai importanta** interogare SQL.
- Intelegerea setarilor si utilizarea inteligenta a indecsilor stau la baza eficientei unei aplicatii
- E absolut necesara realizarea interogarii in asa fel incat datele returnate sa fie exact cele dorite (prelucrarea sa se realizeze pe server-ul MySql)

SELECT

- `select_expr`: macar o expresie selectata trebuie sa apara
 - identifica ceea ce trebuie extras ca valori de iesire din baza de date
 - pot fi nume de coloana(e)
 - pot fi date de sinteza (rezultate din utilizarea unor functii MySql) – necesara atribuirea unui Alias
 - `SELECT CONCAT(last_name,', ',first_name) AS full_name FROM mytable ORDER BY full_name;`

SELECT

- WHERE where_condition, HAVING where_condition sunt utilizate pentru a introduce criterii de selectie
 - in general au comportare similara si sunt interschimbabile
 - WHERE accepta orice operatori mai putin functii aggregate – de “sumare” (COUNT, MAX)
 - HAVING accepta functii aggregate, dar se aplica la sfarsit, exact inainte de a fi trimise datele clientului, **fara nici o optimizare** – utilizarea este recomandata doar cand nu exista echivalent WHERE

SELECT

- ORDER BY {col_name | expr | position} [ASC | DESC]
 - ordoneaza datele returnate dupa anumite criterii (valoarea unei anumite coloane sau functii).
 - Implicit ordonarea este crescatoare ASC, dar se poate specifica ordine descrescatoare DESC
- GROUP BY {col_name | expr | position}
 - realizeaza gruparea liniilor returnate dupa anumite criterii
 - permite utilizarea functiilor agregate (de sumare)

SELECT

- GROUP BY – functii aggregate
 - AVG(expresie) – mediere valorilor
 - SELECT student_name, AVG(test_score) FROM student GROUP BY student_name;
 - COUNT(expresie), COUNT(*)
 - SELECT COUNT(*) FROM student;
 - SELECT COUNT(DISTINCT results) FROM student;
 - SELECT student.student_name, COUNT(*) FROM student, course WHERE student.student_id=course.student_id GROUP BY student_name;
 - SELECT columnname, COUNT(columnname) FROM tablename GROUP BY columnname HAVING COUNT(columnname)>1
- Cuvantul cheie DISTINCT este utilizat pentru a procesa doar liniile cu valori diferite
 - exemplu: 100 de note (rezultate) la examen
 - COUNT(results) va oferi raspunsul 100
 - COUNT(DISTINCT results) va oferi raspunsul 7 (notele diferite 4,5,6,7,8,9,10)

SELECT

- GROUP BY – functii aggregate
 - MIN(expresie), MAX(expresie) – minim si maxim
 - SELECT student_name, MIN(test_score), MAX(test_score) FROM student GROUP BY student_name;
 - SUM(expresie) – sumarea valorilor
 - SELECT year, SUM(profit) FROM sales GROUP BY year;
- WITH ROLLUP – operatii de sumare super-aggregate (un nivel suplimentar de agregare)

SELECT ... WITH ROLLUP

- SELECT year, SUM(profit) FROM sales GROUP BY year;
- SELECT year, SUM(profit) FROM sales GROUP BY year WITH ROLLUP;
 - se obtine un total general, linia "super-aggregate" este identificata dupa valoarea NULL a coloanei dupa care se face sumarea

year	SUM(profit)
2000	4525
2001	3010

year	SUM(profit)
2000	4525
2001	3010
NULL	7535

SELECT

- LIMIT [offset,] row_count | row_count
 - se limiteaza numarul de linii returnate
 - utilizat **frecvent** in aplicatiile web
 - LIMIT 15 – returneaza doar primele 15 linii (1÷15)
 - LIMIT 10,15 – returneaza 15 linii dupa primele 10 linii (11÷25)

JOIN

- Normalizarea si existenta relatiilor intre diversele tabele ale unei baze de date implica faptul ca pentru aflarea unor informatii utilizabile (complete), acestea trebuie extrase **simultan** din mai multe tabele
 - informatie inutilizabila: studentul cu id-ul 253 a luat nota 8 la examenul cu id-ul 35
- Uneori asamblarea informatiilor din mai multe tabele e necesara pentru obtinerea unor rapoarte complexe
 - Exemplu: tabel cu clienti, tabel cu comenzi, tabel cu produse; legatura produse-comenzi e implementata printr-un tabel suplimentar. Raspunsul la intrebarea cate produse x a cumparat clientul y cere tratarea unitara a celor 4 tabele implicate

JOIN

- In general in SQL se poate descrie o astfel de unificare de date intre doua tabele:
 - `left_table JOIN_type right_table criteriu_unificare`
- JOIN_type
 - JOIN – selecteaza toate liniile compuse in care criteriul este indeplinit pentru ambele tabele
 - LEFT JOIN – compune si selecteaza toate liniile din `left_table` chiar daca nu este gasit un corespondent in `right_table`
 - RIGHT JOIN – compune si selecteaza toate liniile din `right table` (similar)
 - FULL JOIN – compune si selecteaza toate liniile din `left_table` si `right_table` fie ca este indeplinit criteriul fie ca nu (nu este implementat in MySql, poate fi simulat)

JOIN

- Clauza JOIN e utilizata pentru a realiza o unificare temporara, dupa anumite criterii, din punct de vedere logic, a doua tabele in vederea extragerii informatiei "suma" dorite
 - left_table [INNER | CROSS] JOIN right_table [join_condition]
 - left_table STRAIGHT_JOIN right_table
 - left_table STRAIGHT_JOIN right_table ON condition
 - left_table LEFT [OUTER] JOIN right_table join_condition
 - left_table NATURAL [LEFT [OUTER]] JOIN right_table
 - left_table RIGHT [OUTER] JOIN right_table join_condition
 - left_table NATURAL [RIGHT [OUTER]] JOIN right_table
 - join_condition: ON conditional_expr | USING (column_list)

JOIN – Exemplu

- Tabel clienti
 - 4 clienti
- Tabel comenzi
 - client 1 – 2 comenzi
 - client 2 – 0 comenzi
 - client 3,4 – 1 comanda

```
CREATE TABLE `clienti` (  
  `id_client` int(10) unsigned NOT NULL auto_increment,  
  `nume` varchar(100) NOT NULL,  
  PRIMARY KEY (`id_client`)  
) ENGINE=InnoDB DEFAULT CHARSET=latin1;
```

```
INSERT INTO `clienti` (`id_client`,`nume`)VALUES  
(1,'Ionescu'),  
(2,'Popescu'),  
(3,'Vasilescu'),  
(4,'Georgescu');
```

```
CREATE TABLE `comenzi` (  
  `id_comanda` int(10) unsigned NOT NULL auto_increment,  
  `id_client` int(10) unsigned NOT NULL,  
  `suma` double NOT NULL,  
  PRIMARY KEY (`id_comanda`)  
) ENGINE=InnoDB DEFAULT CHARSET=latin1;
```

```
INSERT INTO `comenzi` (`id_comanda`,`id_client`,`suma`)VALUES  
(1,1,19.99),  
(2,1,35.15),  
(3,3,17.56),  
(4,4,12.34);
```

INNER JOIN

- INNER JOIN sunt unificarile implicite, in care criteriul (join_condition) trebuie indeplinit in ambele tabele (extensie a cuvintului cheie JOIN pentru evitarea ambiguitatii)
 - OUTER JOIN = {LEFT JOIN | RIGHT JOIN | FULL JOIN} – nu e obligatoriu sa fie indeplinit criteriul in ambele tabele
 - FULL JOIN nu e implementat in MySql, poate fi simulat ca UNION intre LEFT JOIN si RIGHT JOIN
- INNER JOIN sunt echivalente cu realizarea produsului cartezian intre cele doua tabele implicate urmata de verificarea criteriului, daca acesta exista

CROSS JOIN

- In MySql INNER JOIN si CROSS JOIN sunt echivalente in totalitate
 - In SQL standard INNER este folosit in prezenta unui criteriu, CROSS in absenta sa
- INNER (CROSS) JOIN si “,” sunt echivalente cu produsul cartezian intre cele doua tabele implicate in conditiile lipsei criteriului de selectie: fiecare linie a unui tabel este alaturata fiecarei linii din al doilea tabel
 - (un tabel cu M linii si A coloane) CROSS JOIN (un tabel cu N linii si B coloane) → (un tabel cu MxN linii si A+B coloane)

CROSS JOIN

SQL Query Area

```
1 SELECT * FROM clienti JOIN comenzi;  
2 SELECT * FROM clienti, comenzi;  
3 SELECT * FROM clienti INNER JOIN comenzi;  
4 SELECT * FROM clienti CROSS JOIN comenzi;
```

id_client	nume	id_comanda	id_client	suma
1	Ionescu	1	1	19.99
2	Popescu	1	1	19.99
3	Vasilescu	1	1	19.99
4	Georgescu	1	1	19.99
1	Ionescu	2	1	35.15
2	Popescu	2	1	35.15
3	Vasilescu	2	1	35.15
4	Georgescu	2	1	35.15
1	Ionescu	3	3	17.56
2	Popescu	3	3	17.56
3	Vasilescu	3	3	17.56
4	Georgescu	3	3	17.56
1	Ionescu	4	4	12.34
2	Popescu	4	4	12.34
3	Vasilescu	4	4	12.34
4	Georgescu	4	4	12.34

INNER JOIN – criterii

- USING – trebuie sa aiba o coloana cu nume identic in cele doua tabele
 - coloana comuna este afisata o singura data
- ON – accepta orice conditie conditionala
 - chiar daca numele coloanelor din conditie sunt identice, sunt tratate ca entitati diferite (id_client apare de doua ori provenind din cele doua tabele)

SQL Query Area				
1	<code>SELECT * FROM clienti INNER JOIN comenzi USING (id_client);</code>			
id_client	nume	id_comanda	suma	
1	Ionescu	1	19.99	
1	Ionescu	2	35.15	
3	Vasilescu	3	17.56	
4	Georgescu	4	12.34	
1	<code>SELECT * FROM clienti INNER JOIN comenzi ON (clienti.id_client=comenzi.id_client);</code>			
id_client	nume	id_comanda	id_client	suma
1	Ionescu	1	1	19.99
1	Ionescu	2	1	35.15
3	Vasilescu	3	3	17.56
4	Georgescu	4	4	12.34

NATURAL JOIN

- NATURAL JOIN e echivalent cu o unificare INNER JOIN cu o clauza USING(...) care utilizeaza toate coloanele cu nume comun intre cele doua tabele

SQL Query Area			
1	<code>SELECT * FROM clienti NATURAL JOIN comenzi;</code>		
id_client	nume	id_comanda	suma
1	Ionescu	1	19.99
1	Ionescu	2	35.15
3	Vasilescu	3	17.56
4	Georgescu	4	12.34

LEFT JOIN

- Unificare de tip OUTER JOIN
- Se returneaza linia din left_table chiar daca nu exista corespondent in right_table (se introduc valori NULL)
- Cuvantul cheie OUTER este optional

```
SQL Query Area
1 | SELECT * FROM clienti LEFT OUTER JOIN comenzi USING(id_client);
```

id_client	nume	id_comanda	suma
1	Ionescu	1	19.99
1	Ionescu	2	35.15
2	Popescu	NULL	NULL
3	Vasilescu	3	17.56
4	Georgescu	4	12.34

RIGHT JOIN

- Unificare de tip OUTER JOIN
- Se returneaza linia din right_table chiar daca nu exista corespondent in left_table
- Echivalent cu LEFT JOIN cu tabelele scrise in ordine inversa

SQL Query Area

```
1 SELECT * FROM clienti RIGHT OUTER JOIN comenzi USING(id_client);
```

id_client	id_comanda	suma	nume
1	1	19.99	Ionescu
1	2	35.15	Ionescu
3	3	17.56	Vasilescu
4	4	12.34	Georgescu

SQL Query Area

```
1 SELECT * FROM comenzi RIGHT OUTER JOIN clienti USING(id_client);
```

id_client	nume	id_comanda	suma
1	Ionescu	1	19.99
1	Ionescu	2	35.15
2	Popescu	NULL	NULL
3	Vasilescu	3	17.56
4	Georgescu	4	12.34

JOIN

- STRAIGHT_JOIN – forteaza citirea mai intai a valorilor din left_table si apoi a celor din right_table (in anumite cazuri citirea se realizeaza invers)
- USE_INDEX, IGNORE_INDEX, FORCE_INDEX controlul index-ului utilizat pentru gasirea si selectia liniilor, poate aduce spor de viteza

UNION

- Combina rezultatele mai multor interogari SELECT intr-un singur rezultat general
- SELECT ... UNION [ALL | DISTINCT]
SELECT ... [UNION [ALL | DISTINCT]
SELECT ...]
- Poate fi folosit pentru a realiza FULL JOIN

```
SQL Query Area
1 SELECT * FROM comenzi LEFT JOIN clienti ON (comenzi.id_client=clienti.id_client)
2 UNION
3 SELECT * FROM comenzi RIGHT JOIN clienti ON (comenzi.id_client=clienti.id_client)
4 WHERE comenzi.id_client IS NULL
```

id_comanda	id_client	suma	id_client	nume
1	1	19.99	1	Ionescu
2	1	35.15	1	Ionescu
3	3	17.56	3	Vasilescu
4	4	12.34	4	Georgescu
NULL	NULL	NULL	2	Popescu

Subquery

- O “subinterogare” este o interogare de tip SELECT utilizata ca operand intr-o alta interogare
- O “subinterogare” poate fi privit ca un tabel temporar si tratat ca atare (inclusiv cu JOIN) eventual cu atribuire de nume (Alias) daca este nevoie
- Exemple
 - `SELECT * FROM t1 WHERE column1 = (SELECT column1 FROM t2);`

Subquery

- Subquery – un instrument foarte puternic
- permite selectii in doua sau mai multe etape
 - o prima selectie **dupa un criteriu**
 - urmata de o doua selectie **dupa un alt criteriu** in **rezultatele primei selectii**
 - ... samd
- Exista restrictii asupra tabelelor implicate pentru evitarea prelucrarilor recursive (bucle potential infinite)
 - ex: UPDATE tabel₁ SET ... SELECT ... FROM tabel₁ nu este permis

Subquery

- Subquery – un instrument foarte puternic
- Permite evitarea multor prelucrari PHP si trimiterea lor spre server-ul MySql
 - `INSERT INTO tabel1 ... SELECT ... FROM tabel2` permite inserarea printr-o singura interogare a mai multor linii in tabel1 (in functie de numarul de linii rezultate din tabel2)

Acces la server-ul MySql din PHP

Acces la server-ul MySQL din PHP

- Bibliotecile corespunzatoare trebuie activate in php.ini – vezi laboratorul 1.
 - mysql
 - mysqli (improved accesul la functionalitati ulterioare MySQL 4.1)
- O baza de date existenta poate fi accesata daca exista un utilizator cunoscut in PHP cu drepturi de acces corespunzatoare – vezi laboratorul 1.
- O baza de date poate fi creata si din PHP dar nu e metoda recomandata daca nu e necesara
 - cod dificil de implementat pentru **o singura** utilizare
 - necesita existenta unui utilizatori cu drepturi mai mari pentru crearea bazei de date si alocarea de drepturi unui utilizator restrans

Funcții PHP de acces MySQL

- `mysql_connect`
 - realizarea unei conexiuni cu server-ul MySQL
 - resource `mysql_connect` (string server, string user, string password)
 - rezultatul
 - succes – resursa (conexiune, link_identifier)
 - esec – false
- `mysql_select_db`
 - selectează **baza de date** de pe server cu care se va lucra în continuare
 - bool `mysql_select_db` (string database [, resource link_identifier])

Funcții PHP de acces MySQL

- `mysql_query`
 - trimiterea unei interogari SQL spre server
 - resource `mysql_query` (string query [, resource link_identifier])
 - rezultatul
 - SELECT, SHOW, DESCRIBE sau EXPLAIN – resursa (tabel)
 - UPDATE, DELETE, DROP, etc – true/false
- `mysql_fetch_assoc`
 - returneaza o **matrice asociativa** corespunzatoare liniei de la indexul intern (indecsi de tip sir corespunzatori denumirii coloanelor – field – din tabelul de date) si incrementeaza indexul intern sau **false** daca nu mai sunt linii
 - array `mysql_fetch_assoc` (resource result)

Functii PHP de acces MySql

Parcurgerea resurselor rezultat

- `mysql_fetch_assoc`
 - returneaza o **matrice asociativa** corespunzatoare liniei de la indexul intern (indecsi de tip sir corespunzatori denumirii coloanelor – field – din tabelul de date) si incrementeaza indexul intern sau **false** daca nu mai sunt linii
 - array `mysql_fetch_assoc` (resource result)
- `mysql_fetch_row`
 - returneaza o matrice cu indecsi intregi
 - array `mysql_fetch_row` (resource result)

Funcții PHP de acces MySQL

Parcurgerea resurselor rezultat

- `mysql_fetch_array`
 - grupează funcționalitatea `mysql_fetch_assoc` și `mysql_fetch_row`
 - array `mysql_fetch_array` (resource result [, int result_type])
 - `MYSQL_ASSOC`, `MYSQL_NUM`, `MYSQL_BOTH` (implicit)
- `mysql_data_seek`
 - muta indexul intern la valoarea indicată
 - bool `mysql_data_seek` (resource result, int row_number)

Resurse MySQL

- Resursele reprezinta o combinatie intre
 - date structurate (valori + structura) rezultate in urma unor interogari SQL
 - functii de acces la aceste date/structuri
- Analogie cu POO
 - o "clasa speciala" creata in urma interogarii cu functii predefinite de acces la datele respective

Resurse MySQL

Structura

Index intern	Col 1 (tip date)	Col 2 (tip date)
1			
2			
...			

Date

Index intern	Col 1	Col 2
1	Val 11	Val 12	...
2	Val 21	Val 22	...
...

Functii de acces la structura



Functii de acces la date



Acces direct

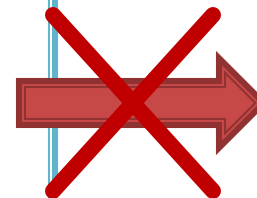

Resurse MySQL

- Functiile de acces la structura sunt rareori utilizate
 - majoritatea aplicatiilor sunt concepute pe structura fixa, si cunosc structura datelor primite
 - exceptie: aplicatii generale, ex.: PhpMyAdmin
- Majoritatea functiilor de acces la date sunt caracterizate de acces secvential
 - se citesc in intregime valorile stocate pe o linie
 - simultan se avanseaza indexul intern pe urmatoarea pozitie, pregatindu-se urmatoarea citire

Resurse MySQL

- Functiile sunt optimizate pentru utilizarea lor intr-o structura de control **do {} while()**, sau **while() {}** de control
 - returneaza FALSE cand "s-a ajuns la capat"
- tipic se realizeaza o citire (mysql_fetch_assoc) urmata de o bucla **do {} while()**
 - pentru a se putea introduce cod de detectie probleme rulat o singura data

Exemplu de utilizare

```
$hostname = "localhost";  
$database = "world";  
$username = "web";  
$password = "ceva";  
$conex= mysql_connect($hostname, $username, $password);  
mysql_select_db($database, $conex);
```

```
$query = "SELECT `Code`, `Name`, `Population` FROM `country` AS c ";  
$result = mysql_query($ query, $conex) or die(mysql_error());  
$row_result = mysql_fetch_assoc($ result );  
$totalRows_result = mysql_num_rows($ result );
```

Exemplu de utilizare

```
<?php
do {?>
<tr>
    <td><?php echo $index; ?>&nbsp;  </td>
    <td><?php echo $ row_result ['Code']; ?>&nbsp;  </td>
    <td><?php echo $ row_result ['Name']; ?>&nbsp;  </td>
    <td><?php echo $ row_result ['Population']; ?>&nbsp;  </td>
</tr>
<?php
    $index++;
}
while ($ row_result = mysql_fetch_assoc($ result )); ?>
```

Modificari laborator cu date stocate text

- Codul aplicatiei ramane in mare parte acelasi
- Se modifica doar citirea valorilor pentru popularea matricii \$produse ("antet.php")

```
$vect=file("produse.txt");  
foreach ($vect as $linie)  
    {  
        $valori=explode("\t",$linie,5);  
        $produse[$valori[0]] [$valori[1]]=array ("descr" => $valori[2], "pret" => $valori[3], "cant" =>  
$valori[4]);  
    }
```

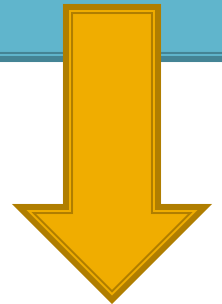

Modificari laborator cu date stocate XML

XML

```
$xml = simplexml_load_file("lista.xml");
if ($xml)
{
foreach ($xml->categorie as $categorie)
    {
    $produse[(string)$categorie["nume"]]=array();
    foreach ($categorie->produs as $prod_cur)
        {
        $produse[(string)$categorie["nume"]][(string)$prod_cur->nume]=array
("descr" => (string)$prod_cur->desc, "pret" => (string)$prod_cur->pret,
"cant" => (string)$prod_cur->cant);
        }
    }
}
```

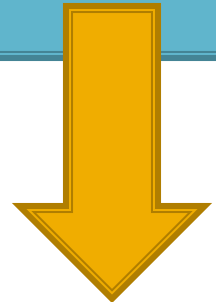

Modificari laborator cu date stocate

MySQL

```
$hostname = "localhost";
$database = "tmpaw";
$username = "web";
$password = "test";
$conex= mysql_connect($hostname, $username, $password);
mysql_select_db($database, $conex);
$query = "SELECT * FROM `categorii` AS c";
$result_c = mysql_query($query, $conex) or die(mysql_error());
$row_result_c = mysql_fetch_assoc($result_c);
$totalRows_result = mysql_num_rows($result_c);
do {
    $query = "SELECT * FROM `produse` AS p WHERE `id_categ` = ".$row_result_c['id_categ'];
    $result_p = mysql_query($query, $conex) or die(mysql_error());
    $row_result_p = mysql_fetch_assoc($result_p);
    $totalRows_result = mysql_num_rows($result_p);
    $produse[$row_result_c['nume']] = array();
    do {
        $produse[$row_result_c['nume']][$row_result_p['nume']] = array ("descr" =>
$row_result_p['detalii'], "pret" => $row_result_p['pret'], "cant" => $row_result_p['cant']);
    }
    while ($row_result_p = mysql_fetch_assoc($result_p));
}
while ($row_result_c = mysql_fetch_assoc($result_c));
```

Optimizare

- o singura interogare SQL, unirea tabelelor (JOIN) lasata in baza server-ului MySql

```
$hostname = "localhost";
$database = "tmpaw";
$username = "web";
$password = "test";
$conex= mysql_connect($hostname, $username, $password);
mysql_select_db($database, $conex);

$query = "SELECT p.*, c.`nume` AS `nume_categ` FROM `produse` AS p
        LEFT JOIN `categorii` AS c ON (c.`id_categ` = p.`id_categ`)";
$result = mysql_query($query, $conex) or die(mysql_error());
$row_result = mysql_fetch_assoc($result);
$totalRows_result = mysql_num_rows($result);

do{
    $produse[$row_result['nume_categ']][$row_result['nume']] = array ("descr" => $row_result['detalii'], "pret"
=> $row_result['pret'], "cant" => $row_result['cant']);
}
while ($row_result = mysql_fetch_assoc($result));
```

Functii de acces la server-ul MySQL

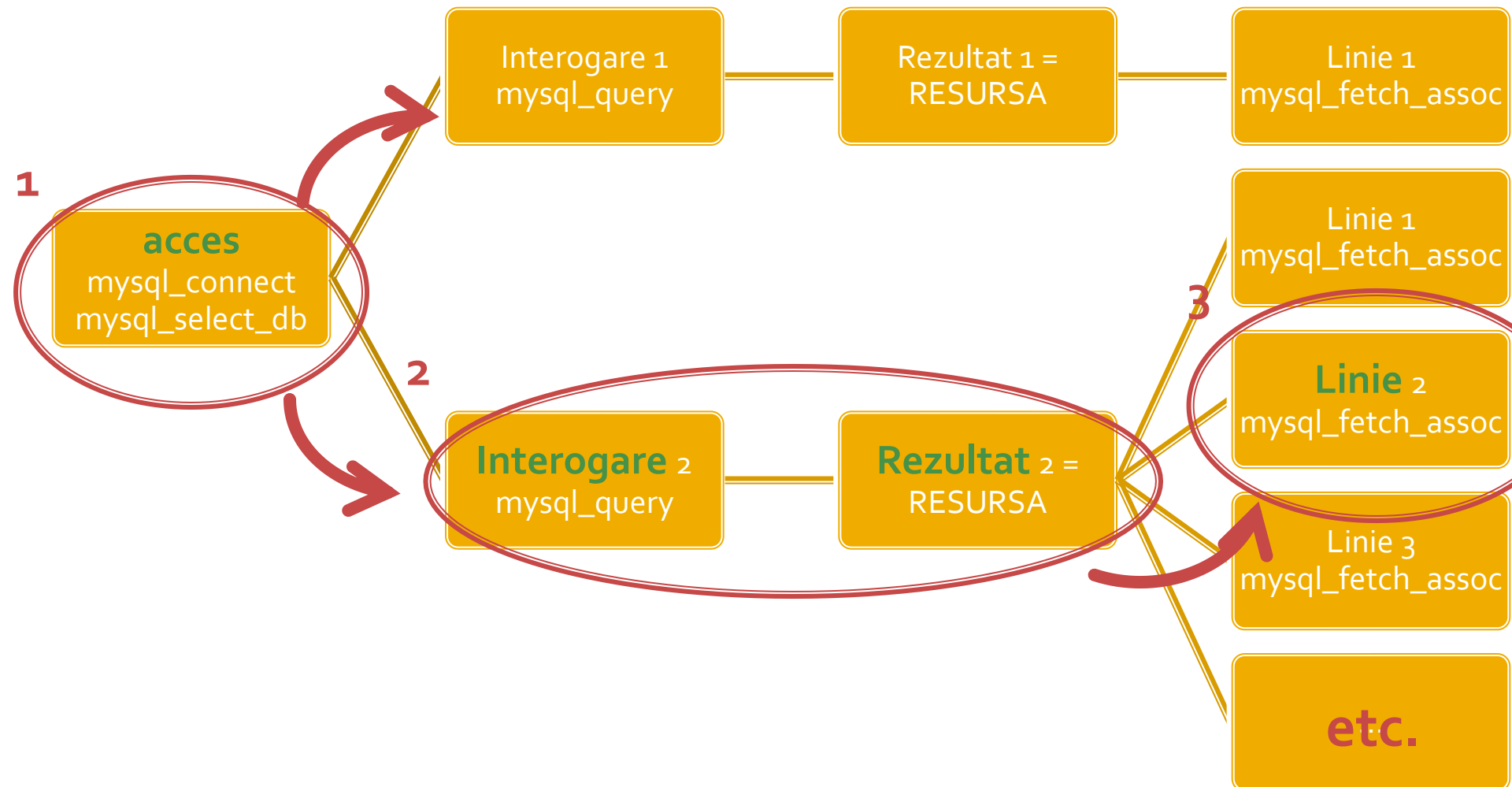

!! IMPORTANT

PHP > 5.5

PHP 5.5

- Incapand cu versiunea 5.5 a PHP extensia mysql este declarata **depreciata**
 - orice utilizare a unei functii genereaza eroare de tip **E_DEPRECATED**
 - se preconizeaza ca in PHP > 6 aceasta extensie va fi eliminata total (**realizat PHP7 PHP8**)
- Alternativele de utilizare sunt
 - extensia **mysqli** (MySQL Improved)
 - extensia **PDO** (PHP Data Objects)

Extensia mysqli

- Inafara securitatii sporite ofera acces la facilitatile curente ale server-ului MySQL
 - accesul la interogari predefinite (Prepared Statements) (viteza, securitate)
 - server side
 - client side
 - proceduri stocate pe server (viteza, securitate)
 - interogari multiple
 - tranzactii (integritate)

Extensia mysqli

- Doua modalitati de utilizare
 - procedurala (similar mysql)
 - POO (similar PDO)
- Utilizarea procedurala (aproape) similara cu utilizarea extensiei originale mysql
 - tranzitie facila
 - tranzitie cu mici diferente de parametri

mysqli – Procedural

```
<?php
$mysqli = mysqli_connect("example.com", "user", "password", "database");
$res = mysqli_query($mysqli, "SELECT 'Please do not use the mysql extension ' AS _msg FROM DUAL");
$row = mysqli_fetch_assoc($res);
echo $row['_msg'];

$mysqli = mysqli_connect("example.com", "user", "password");
mysqli_select_db("test");
$res = mysqli_query("SELECT ' for new developments.' AS _msg FROM DUAL", $mysqli);
$row = mysqli_fetch_assoc($res);
echo $row['_msg'];
?>
```

- toate functiile mysql au un echivalent mysqli
- majoritatea functiilor au aceeasi parametri in aceeasi ordine
- sunt totusi functii cu mici diferente (Ex: **mysqli_connect**, **mysqli_query**)

mysqli – Programare orientata obiect

```
<?php
$var = new mysqli("example.com", "user", "password", "database");
$res = $var->query ($mysqli, "SELECT 'Please do not use the mysql extension ' AS _msg FROM DUAL");
$row = $res->fetch_assoc();
echo $row['_msg'];

$mysqli = mysqli_connect("example.com", "user", "password");
mysqli_select_db("test");
$res = mysqli_query("SELECT ' for new developments.' AS _msg FROM DUAL", $mysqli);
$row = mysqli_fetch_assoc($res);
echo $row['_msg'];
?>
```

Resurse MySQL – mysqli

Structura

Index intern	Col 1 (tip date)	Col 2 (tip date)
1			
2			
...			

Date

Index intern	Col 1	Col 2
1	Val 11	Val 12	...
2	Val 21	Val 22	...
...

Metode

Constructor	query	fetch_assoc
-------------	-------	-------------	------

Functii de acces la structura



Functii de acces la date



Acces direct

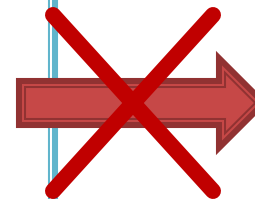

Metode atasate resursei



Conversia la mysql (obligatorie)

■ exemplul anterior

```
$hostname = "localhost";
$database = "tmpaw";
$username = "web";
$password = "test";
$conex= mysql_connect($hostname, $username, $password);
mysql_select_db($database, $conex);

$query = "SELECT p.*, c.`nume` AS `nume_categ` FROM `produse` AS p
        LEFT JOIN `categorii` AS c ON (c.`id_categ` = p.`id_categ`)";
$result = mysql_query($query, $conex) or die(mysql_error());
$row_result = mysql_fetch_assoc($result);
$totalRows_result = mysql_num_rows($result);

do{
    $produse[$row_result['nume_categ']][$row_result['nume']]=array ("descr" => $row_result['detalii'], "pret"
=> $row_result['pret'], "cant" => $row_result['cant']);
}
while ($row_result = mysql_fetch_assoc($result));
```



mysqli (Procedural)

```
//$conex= mysql_connect($hostname, $username, $password);
//mysql_select_db($database, $conex);
$conex = mysqli_connect($hostname, $username, $password, $database);

$query = "SELECT p.*, c.`nume` AS `nume_categ` FROM `produse` AS p
        LEFT JOIN `categorii` AS c ON (c.`id_categ` = p.`id_categ`)";
//$result = mysql_query($query, $conex) or die(mysql_error());
$result = mysqli_query($conex, $query);

//$row_result = mysql_fetch_assoc($result);
$row_result = mysqli_fetch_assoc($result);

//$totalRows_result = mysql_num_rows($result);
$totalRows_result = mysqli_num_rows($result);

do {
    $produse[$row_result['nume_categ']][$row_result['nume']]=array ("descr" => $row_result['detalii'], "pret"
=> $row_result['pret'], "cant" => $row_result['cant']);
}
//while ($row_result = mysql_fetch_assoc($result));
while ($row_result = mysqli_fetch_assoc($result));
```

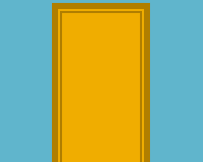

mysqli (POO)

```
//$conex= mysql_connect($hostname, $username, $password);
//mysql_select_db($database, $conex);
//$conex = mysqli_connect($hostname, $username, $password, $database);
$conex = new mysqli($hostname, $username, $password, $database);

$query = "SELECT p.*, c.`nume` AS `nume_categ` FROM `produse` AS p
        LEFT JOIN `categorii` AS c ON (c.`id_categ` = p.`id_categ`)";
//$result = mysql_query($query, $conex) or die(mysql_error());
//$result = mysqli_query($conex, $query);
$result = $conex->query( $query );

//$row_result = mysql_fetch_assoc($result);
//$row_result = mysqli_fetch_assoc($result);
$row_result = $result->fetch_assoc();

//$totalRows_result = mysql_num_rows($result);
//$totalRows_result = mysqli_num_rows($result);
$totalRows_result = $result->num_rows;

do {
    $produse[$row_result['nume_categ']][$row_result['nume']] = array ("descr" => $row_result['detalii'], "pret"
=> $row_result['pret'], "cant" => $row_result['cant']);
}
//while ($row_result = mysql_fetch_assoc($result));
while ($row_result = $result->fetch_assoc(););
```

Laborator 6

Plan aplicatie – Cumparator

- Pe masura ce aplicatia paraseste un fir liniar de executie este necesara introducerea unui plan (graf) al aplicatiei
- Cumparator
 - citirea fisierului text (XML) se realizeaza in antet.php, comun pentru toate fisierele

lista_categ.php
ALEGERE CATEGORIE

formular.php
INTRODUCERE DATE

rezultat.php
PRELUCRARE
COMANDA

Rezultat (comparator)

Categorii Produse

Alegeti categoria:

Nr.	Categorie	Total Produse
1	Papetarie	3
2	Instrumente	3
3	Audio-video	3
4	Calculatoare	3
5	Jucarii	2

Total produse: 14

Magazin online Firma X SRL

Finalizati comanda

Nr.	Produs	Pret	Cantitate
1	Carti	100	<input type="text" value="1"/>
2	Caiete	50	<input type="text" value="2"/>
3	Penare	150	<input type="text" value="1"/>
4	Stilouri	125	<input type="text" value="0"/>
5	Creioane	25	<input type="text" value="0"/>

Magazin online Firma X SRL

Rezultate comanda

Pret total (fara TVA): 350

Pret total (cu TVA): 416.5

Comanda receptionata la data: 17/03/2010 ora 08:24



Plan aplicatie – Vanzator

- Aparitia aplicatiei pentru vanzator
 - introduce un fir paralel de executie cu necesitatea alegerii initiale: cumparator/vanzator
 - aduce posibilitatea scrierii fisierului XML
 - diverse operatii de scriere
 - introducere categorie de produse
 - introducere produs nou intr-o categorie existenta
 - modificare produs existent
 - modificarea fisierului implica 2 actiuni:
 - colectare date
 - prelucrare

Plan aplicatie (Proiect !!)

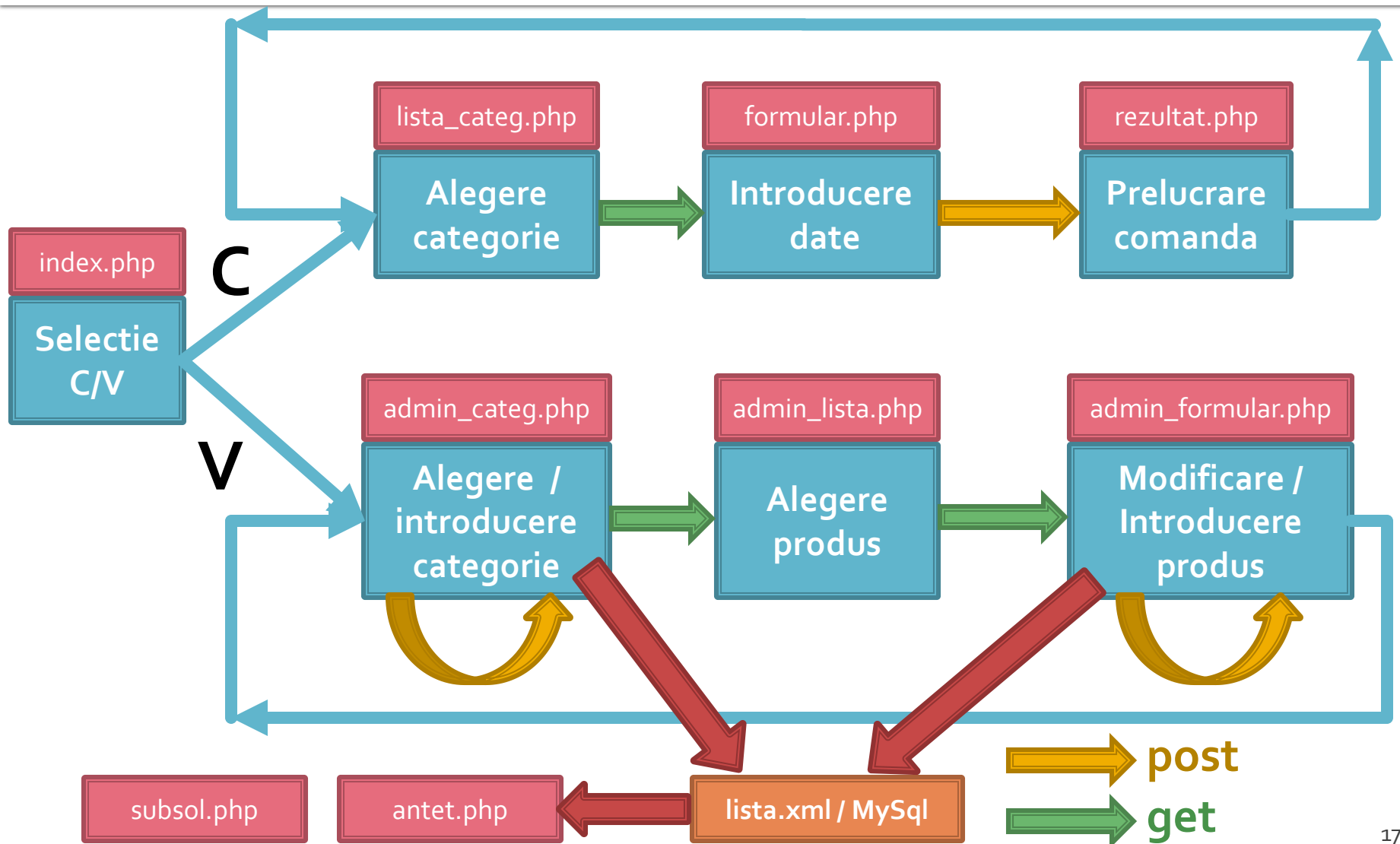

Rezultat (vanzator)

Magazin Firma X

[Inceput](#) | [Inapoi](#)

Magazin online Firma X SRL

Alegeti:

- [Cumparator](#)
- [Vanzator](#)

Categorii Produse

Alegeti categoria:

Nr.	Categorie	Total Produse
1	Papetarie	3
2	Instrumente	3
3	Audio-video	3
4	Calculatoare	3
5	Jucarii	2

Total produse: 14

Categorie noua de produse:

Lista produse in categoria Calculatoare

Nr.	Produs	Descriere	Pret	Cantitate	Actiuni
1	Laptop	calculator mic	2000	2	modifica
2	Desktop	calculator mare	1000	5	modifica
3	Imprimanta	prn	200	2	modifica
-	Produs nou				adauga

Produs in categoria Calculatoare

Produs	<input type="text" value="laptop"/>
Descriere	<input type="text" value="calculator mic"/>
Pret	<input type="text" value="2000"/>
Cantitate	<input type="text" value="2"/>



Laborator 6

- Sa se continue magazinul virtual cu:
 - produsele sunt grupate pe categorii de produse
 - sa prezinte utilizatorului o lista de grupe de produse pentru a alege
 - sa prezinte utilizatorului o lista de produse si preturi in grupa aleasa
 - lista de produse si preturi se citeste dintr-o baza de date **MySQL**
 - se preia comanda si se calculeaza suma totala
 - **se creaza paginile prin care vanzatorul poate modifica preturile, produsele, categoriile**

! Important

- Laborator **asincron!**

- recomandat – 4 = Optim

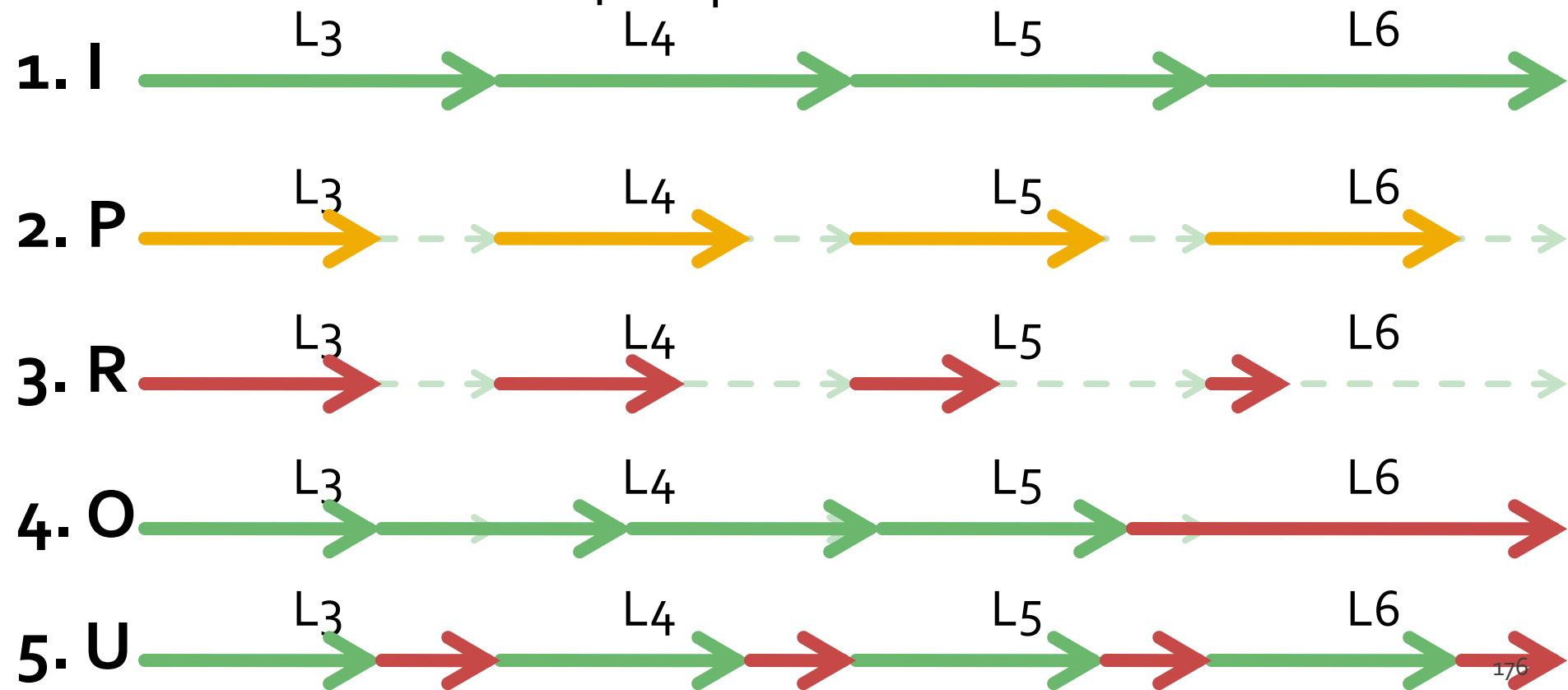

Laborator 6/7 – Mod de lucru

- Se continua lucrul la aplicatie (L5)
- Se recomanda laboratorul **asincron**
- Se poate folosi fisierul cu surse cypaste.txt
(site-<https://rf-opto.etti.tuiasi.ro>)

Laborator 6/7 – Mod de lucru

- Se ia o decizie relativ la relatia dintre produse si categorii (S70-S73)
 - One to Many
 - Many to Many
- Se creaza cele 2(3) tabele corespunzatoare
- Se populeaza cu date
- Se actualizeaza planul aplicatiei pentru a corespunde cu aplicatia proprie
 - nume de fisiere, tipuri de transfer a datelor

Rezultat (comparator)

Categorii Produse

Alegeti categoria:

Nr.	Categorie	Total Produse
1	Papetarie	3
2	Instrumente	3
3	Audio-video	3
4	Calculatoare	3
5	Jucarii	2

Total produse: 14

Magazin online Firma X SRL

Finalizati comanda

Nr.	Produs	Pret	Cantitate
1	Carti	100	<input type="text" value="1"/>
2	Caiete	50	<input type="text" value="2"/>
3	Penare	150	<input type="text" value="1"/>
4	Stilouri	125	<input type="text" value="0"/>
5	Creioane	25	<input type="text" value="0"/>

Magazin online Firma X SRL

Rezultate comanda

Pret total (fara TVA): 350

Pret total (cu TVA): 416.5

Comanda receptionata la data: 17/03/2010 ora 08:24



Rezultat (vanzator)

Magazin Firma X

[Inceput](#) | [Inapoi](#)

Magazin online Firma X SRL

Alegeti:

- [Cumparator](#)
- [Vanzator](#)

Categorii Produse

Alegeti categoria:

Nr.	Categorie	Total Produse
1	Papetarie	3
2	Instrumente	3
3	Audio-video	3
4	Calculatoare	3
5	Jucarii	2

Total produse: 14

Categorie noua de produse:

Lista produse in categoria Calculatoare

Nr.	Produs	Descriere	Pret	Cantitate	Actiuni
1	Laptop	calculator mic	2000	2	modifica
2	Desktop	calculator mare	1000	5	modifica
3	Imprimanta	prn	200	2	modifica
-	Produs nou				adauga

Produs in categoria Calculatoare

Produs	<input type="text" value="laptop"/>
Descriere	<input type="text" value="calculator mic"/>
Pret	<input type="text" value="2000"/>
Cantitate	<input type="text" value="2"/>



Plan aplicatie

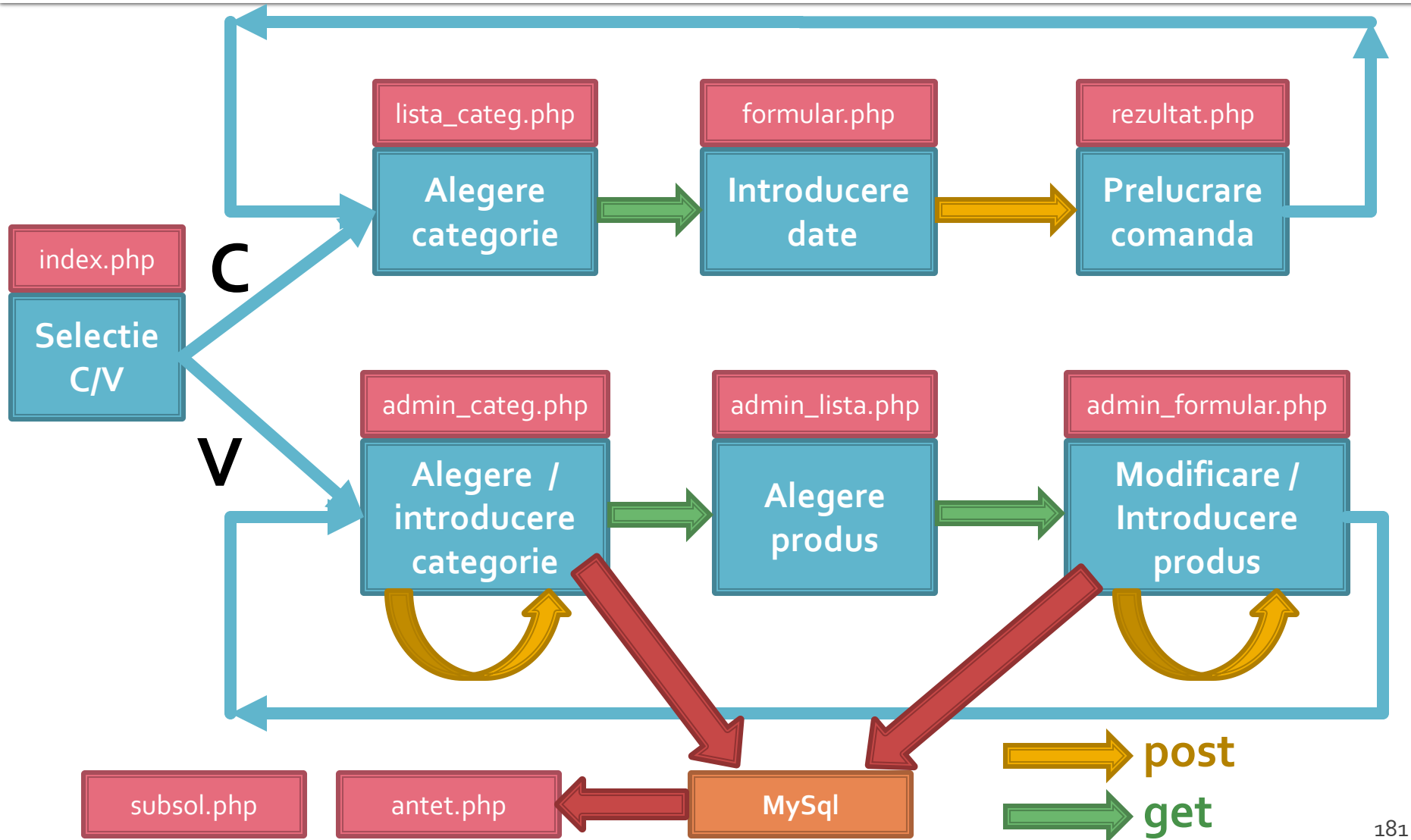

Laborator 6/7 – Mod de lucru

- Se creaza firul de executie paralel pentru vânzător
 - fisierele pentru cumpărător reprezinta o buna cale de pornire (Save As, Copy/Paste) pentru 2 din cele 3 fisiere pentru vânzător
- Se lucreaza cat mai mult la conversia text -> MySQL
 - activitatea se continua la laboratorul 7

Plan aplicatie – vanzator

- Deoarece citirea datelor se face in fisierul antet.php (modificat anterior) vor aparea modificari doar la nivelul scrierii datelor noi introduse
- Fisiere
 - admin_lista.php – nemodificat
 - admin_categ.php – scrie categorii noi in baza de date: se incuieste cod XML cu cod MySql
 - admin_formular.php – scrie produse noi / corectii in baza de date: se incuieste cod XML cu cod MySql

admin_categ.php

```
if (isset($_POST["c_nou"]))
    //categorie noua introdusa
    $categ_nou=$xml->addChild("categorie");
    $categ_nou->addAttribute("nume", $_POST["nou"]);
    $xml->asXML("lista.xml"); // salvare fisier
    $produse[$_POST["nou"]]=array(); // update matrice produse
    echo "<p>Categoria ".$_POST["nou"]." adaugata!</p>";
}
```

```
if (isset($_POST["c_nou"]))
    //categorie noua introdusa
    $query = "INSERT INTO `categorii` (`nume`, `detalii`)VALUES (
".$_POST["nou_nume"]."`, '".$_POST["nou_desc"]."`)";
    echo $query; //util in perioada de testare
    $result = mysql_query($query, $conex) or die(mysql_error());
    $record=mysql_insert_id(); //obtinerea id-ului nou
    $produse[$_POST["nou_nume"]]=array(); // update matrice produse
    echo "<p>Categoria ".$_POST["nou_nume"]." adaugata! Are id = ".$record."</p>";
}
```

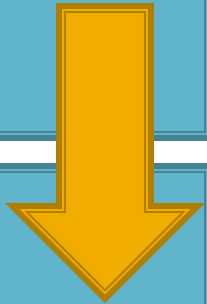

admin_categ.php

Magazin Firma X SRL

[Inceput](#) | [Inapoi](#)

Magazin online Firma X SRL

Categorii Produce

Alegeti categoria:

Nr.	Categorie	Total Produce
1	Papetarie	3
2	Instrumente	3
3	Audio-video	3

Total produse: 9

Categorie noua de produse:

Nume:

Descriere:

Magazin Firma X SRL

[Inceput](#) | [Inapoi](#)

Magazin online Firma X SRL

```
INSERT INTO `categorii` (`nume`, `detalii`) VALUES ('jucarii', 'pentru copii')
```

Categoria jucarii adaugata! Are id = 4

Categorii Produce

Alegeti categoria:

Nr.	Categorie	Total Produce
1	Papetarie	3
2	Instrumente	3
3	Audio-video	3
4	Jucarii	0

Total produse: 9

Categorie noua de produse:

Nume:

Descriere:

Magazin online Firma X SRL

```
INSERT INTO `categorii` (`nume`, `detalii`) VALUES ('jucarii', 'pentru copii')
```

Categoria jucarii adaugata! Are id = 4

admin_formular.php

- Pentru inlocuire/adaugare produs apare o tratare diferita a celor doua situatii:
 - Adaugarea de produs face apel la interogarea SQL `INSERT INTO `produse` ...`
 - Modificarea unui produs existent va face apel la interogarea SQL `UPDATE `produse` SET ...`

admin_formular.php

```
if (isset($_POST["prod_ant"]))//exista deja acest produs anterior?
    //exista deja acest produs UPDATE
    unset($produse[$_POST['categ']][$_POST['prod_ant']]);//trebuie sters produsul anterior inlocuit
    $query = "UPDATE `produse` SET `nume`='".$_POST["prod"]."', `detalii`='".$_POST["descriere"]."',
`cant`='".$_POST["cantitate"]."', `pret`='".$_POST["pret"]."' WHERE `nume`='".$_POST["prod_ant"].'";
    echo $query;//util in perioada de testare
    $result = mysql_query($query, $conex) or die(mysql_error());
    echo "<p>Produsul '".$_POST["prod"]."' modificat in categoria '".$_POST['categ'].'"!</p>";
}
else
    //NU exista acest produs INSERT
    $query = "INSERT INTO `produse` (`nume`, `detalii`, `pret`, `cant`, `id_categ`) VALUES
('".$_POST["prod"]."', '".$_POST["descriere"]."', '".$_POST['pret']."', '".$_POST['cantitate']."',
(SELECT `id_categ` FROM categorii WHERE `nume` = '".$_POST['categ'].')";
    echo $query;//util in perioada de testare
    $result = mysql_query($query, $conex) or die(mysql_error());
    $record=mysql_insert_id();//obtinerea id-ului nou
    echo "<p>Produsul '".$_POST["prod"]."' adaugat in categoria '".$_POST['categ'].'"! Are id =
".$_record."</p>";
}
$produse[$_POST['categ']][$_POST['prod']] = array("descr" => $_POST['descriere'], "pret" => $_POST['pret'], "cant" =>
$_POST['cantitate']);
```

Utilizare LAMP

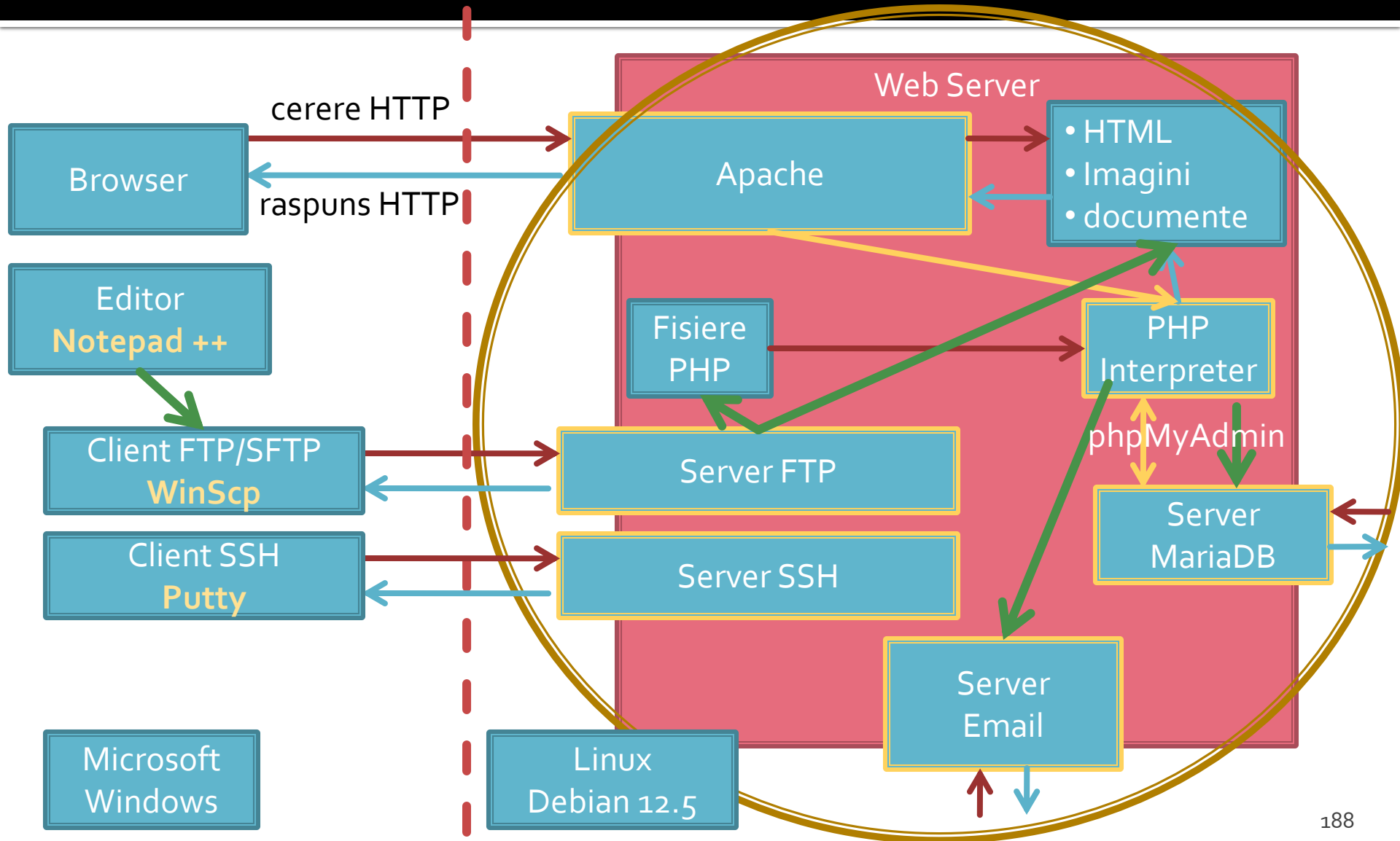

Utilizare LAMP

Magazin online Firma X SRL

Lista Produse

Nr.	Produs	Pret
1	Carti	100
2	Caiete	50
3	Penare	150
4	Stilouri	125
5	Creioane	25

Comanda

Magazin online Firma X SRL

Realizati comanda

Nr.	Produs	Pret	Cantitate
1	Carti	100	<input type="text" value="1"/>
2	Caiete	50	<input type="text" value="2"/>
3	Penare	150	<input type="text" value="1"/>
4	Stilouri	125	<input type="text" value="0"/>
5	Creioane	25	<input type="text" value="0"/>

Trimite

Magazin online Firma X SRL

Rezultate comanda

Pret total (fara TVA): 350

Pret total (cu TVA): 416.5

Comanda receptionata la data: 17/03/2010 ora 08:24

<input name="x" ..

\$_POST['x']

\$_GET['x']

Web Server

Apache

Server FTP

Server SSH

Utilizzare LAMP

1. login → paw:masteretti
2. su - → root:masteretti
2. ifconfig → 192.168.30.5
3. putty.exe → 192.168.30.5 → SSH → root:masteretti (remote login)
4. [alte comenzi linux dorite]
5. FTP → Winscp → SFTP → student:masterrc@192.168.30.5
6. MySql → http://192.168.30.5/phpmyadmin → root:masteretti
7. Apache Error Log →
 - 7a. putty → nano /var/log/httpd/error_log
 - 7b. http://192.168.30.5/logfile.php (nonstandard)
8. PHP info → http://192.168.30.5/info.php

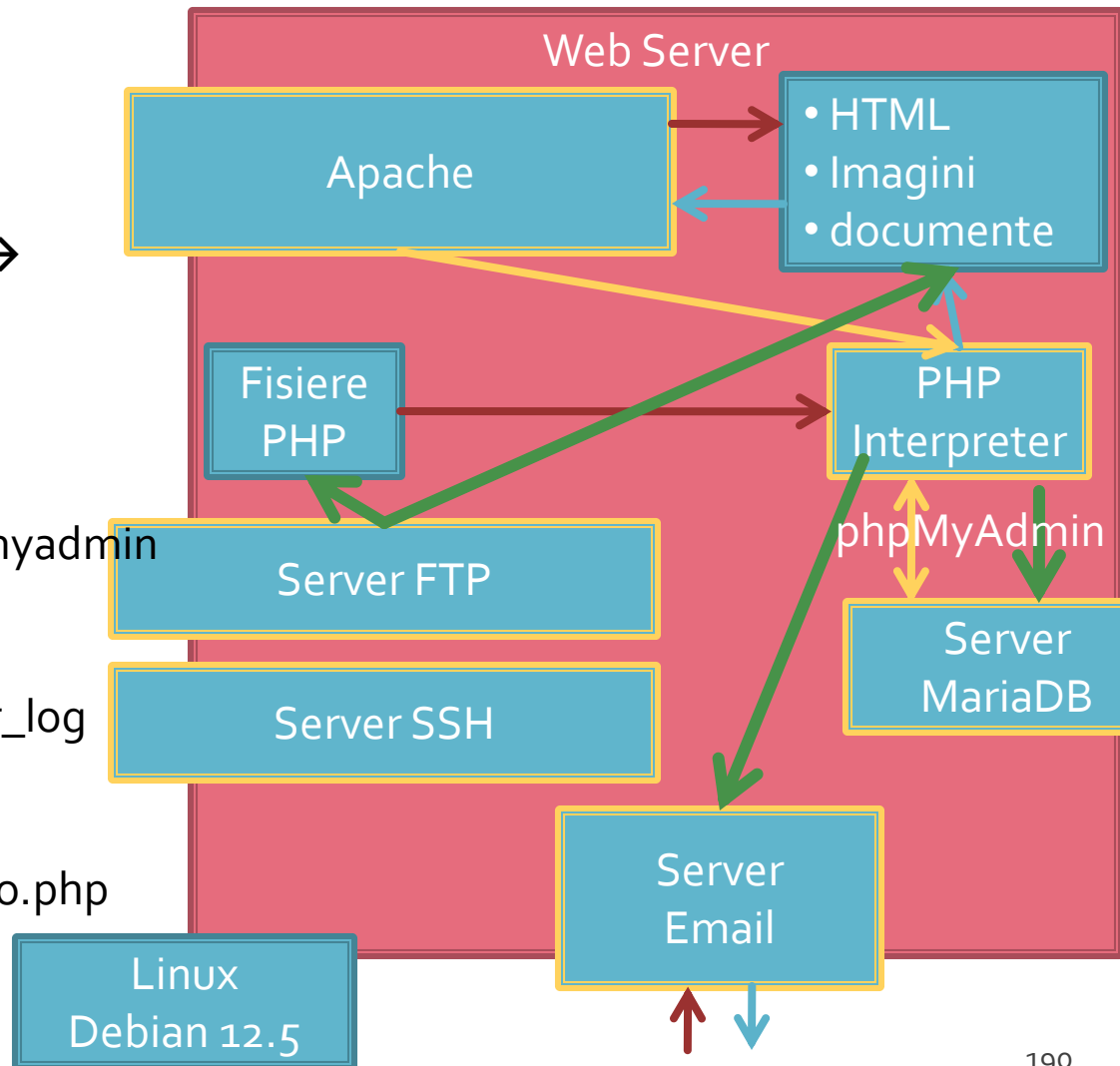

Utilizzare LAMP

1. login → root:masteretti
2. ifconfig → 192.168.30.5
3. putty.exe → 192.168.30.5 → SSH → root:masteretti (remote login)
4. [alte comenzi linux dorite]
5. FTP → Winscp → SFTP → student:masterrc@192.168.30.5
6. MySql → http://192.168.30.5/phpmyadmin → root:masteretti
7. Apache Error Log →
 - 7a. putty → nano /var/log/httpd/error_log
 - 7b. http://192.168.30.5/logfile.php (nonstandard)
8. PHP info → http://192.168.30.5/info.php

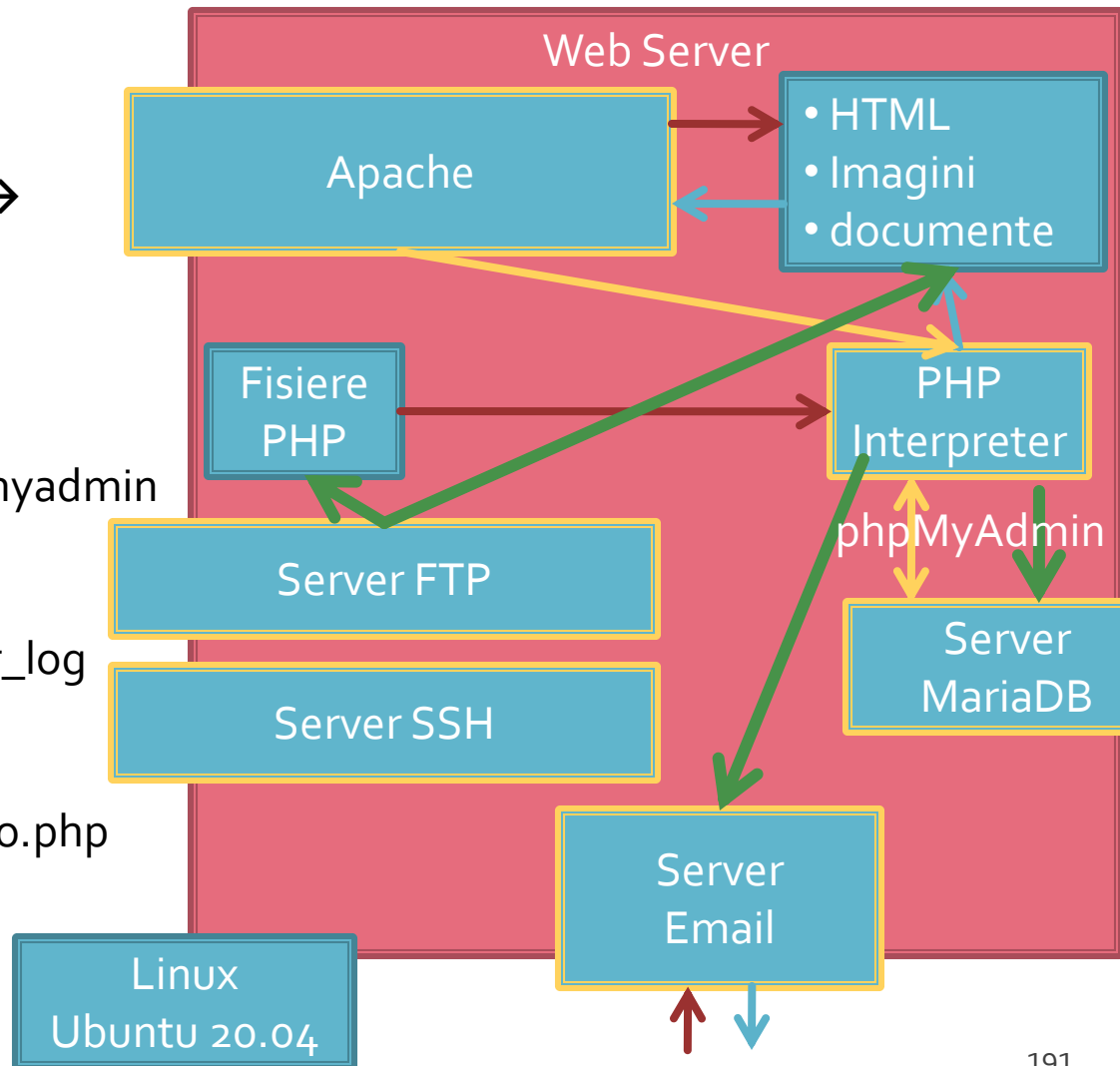

Utilizare LAMP

1. login → root:masterrc
2. ifconfig → 192.168.30.5
3. putty.exe → 192.168.30.5 → SSH → root:masterrc (remote login)
4. [alte comenzi linux dorite]
5. FTP → Winscp → SFTP → student:masterrc@192.168.30.5
6. MySql → http://192.168.30.5/phpmyadmin → root:masterrc
7. Apache Error Log →
 - 7a. putty → nano /var/log/httpd/error_log
 - 7b. http://192.168.30.5/logfile.php (nonstandard)
8. PHP info → http://192.168.30.5/info.php

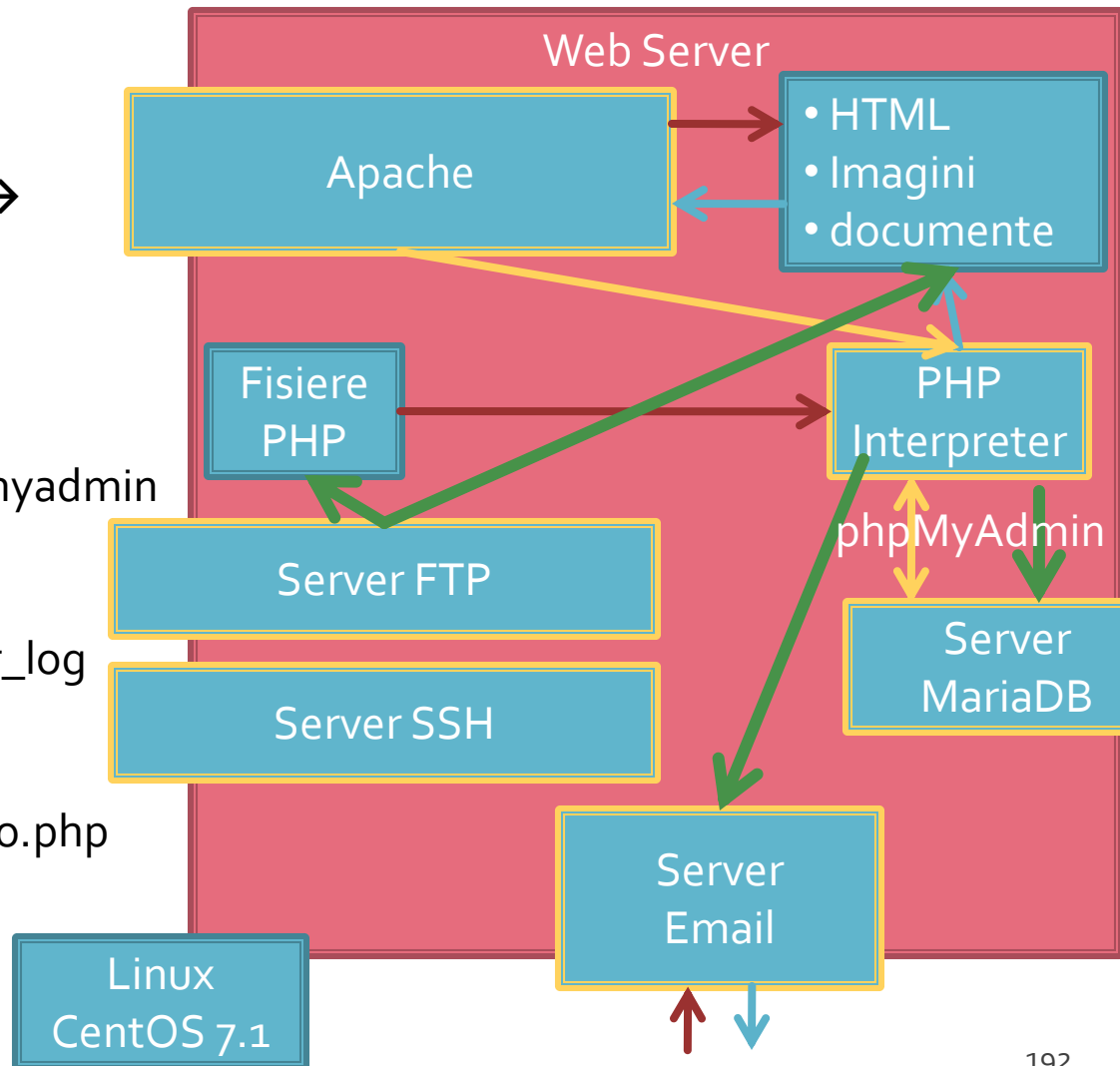

Client / Server

```
<input name="nume" ....>
```

```
echo $_POST['nume']; //ceva  
echo $_GET['nume']; //ceva  
echo $_REQUEST['nume']; //ceva
```

ceva

Trimite

get
post

Interpretor PHP primeste
\$_POST
\$_GET
\$_REQUEST

Depanare

```
echo "<pre>";  
print_r($_POST);  
echo "</pre>";
```

```
<p>temp <?php echo  
"a=";echo $a; ?> </p>
```

Anexa

Server referinta LAMP 2026

- 3 variante acceptate
 - CentOS 7.1
 - Ubuntu 20.04
 - Debian 12.5

Server referinta LAMP

- Centos 7.1
 - PHP 5.4.16
 - MariaDB 5.5.44 / root:masterrc
 - Apache 2.4.6
 - PhpMyAdmin/4.4.15
 - **root**/student:masterrc
 - Python 2.7.5
 - creat: Workstation Player 12.x (**12**)

Server referinta LAMP

- Ubuntu 20.04
 - PHP 7.4.3
 - MariaDB 10.3.31 / root:masteretti
 - Apache 2.4.41
 - **paw/student:masteretti**
 - necesar suplimentar pentru **acces FTP user paw:**
 - sudo usermod -a -G upload paw
 - sudo chmod -R 775 /var/www
 - Python 3.8.10
 - creat: Workstation Player 15.x (**16**)

Server referinta LAMP

- Debian 12.5
 - PHP 8.2.7
 - MariaDB 10.11.6 / root:masteretti
 - Apache 2.4.57
 - PhpMyAdmin/5.2.1 deb
 - **root/paw/student:masteretti**
 - Python 3.11.2
 - creat: Workstation Player 17.5 (**21**)

Server referinta

- rf-opto.etti.tuiasi.ro > Master > Web Design

Project/Design

~~[Teme proiect 2020](#) (pdf, 874.95 KB, ro, 🇷🇴)~~

[Sevrer CentOS pentru VMWare Player \(cloud\)](#) (link, 0 Bytes, ro, 🇷🇴)

~~[Realizare Server CentOS](#) (pdf, 1.4 MB, en, 🇺🇸)~~

Examen

[Simulare Examen \(video\)](#) (mp4, 65.12 MB, ro, 🇷🇴)

[Manual examen on-line](#) (pdf, 2.65 MB, ro, 🇷🇴)

Server referinta

- Cloud ETTI: **RF-opto3#**

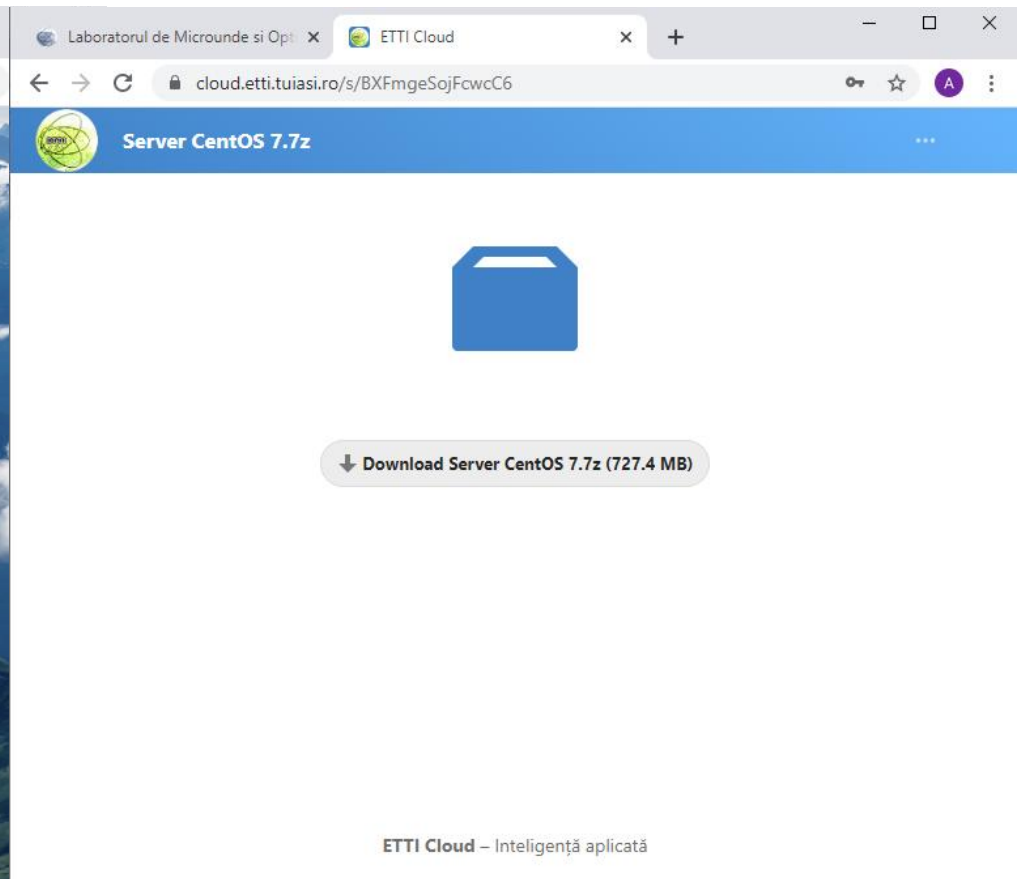
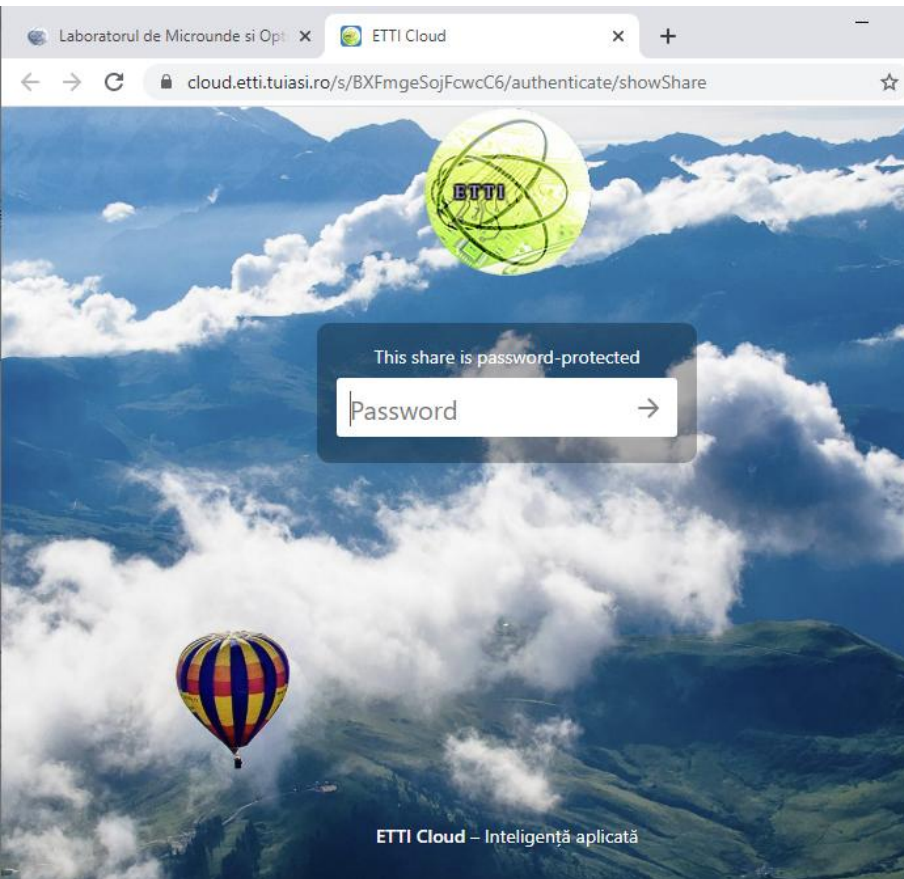

Server referinta

- Masina virtuala
- VMware Workstation Player
 - Gratuit (non-comercial)
 - <https://www.vmware.com/products/workstation-player/workstation-player-evaluation.html>
- Inlocuit de VMware Workstation Pro



VMware Workstation Pro for PC

Build and test nearly any app with the world's leading desktop hypervisor app for Windows and Linux.

DOWNLOAD NOW >

Server referinta

- Masina virtuala
- VMware Workstation Pro (Broadcom)



VMware Workstation Pro for PC

Build and test nearly any app with the world's leading desktop hypervisor app for Windows and Linux.

[DOWNLOAD NOW >](#)



Broadcom Inc. Customer sign-in

Username

Enter your username

Remember me

Next

Server referinta

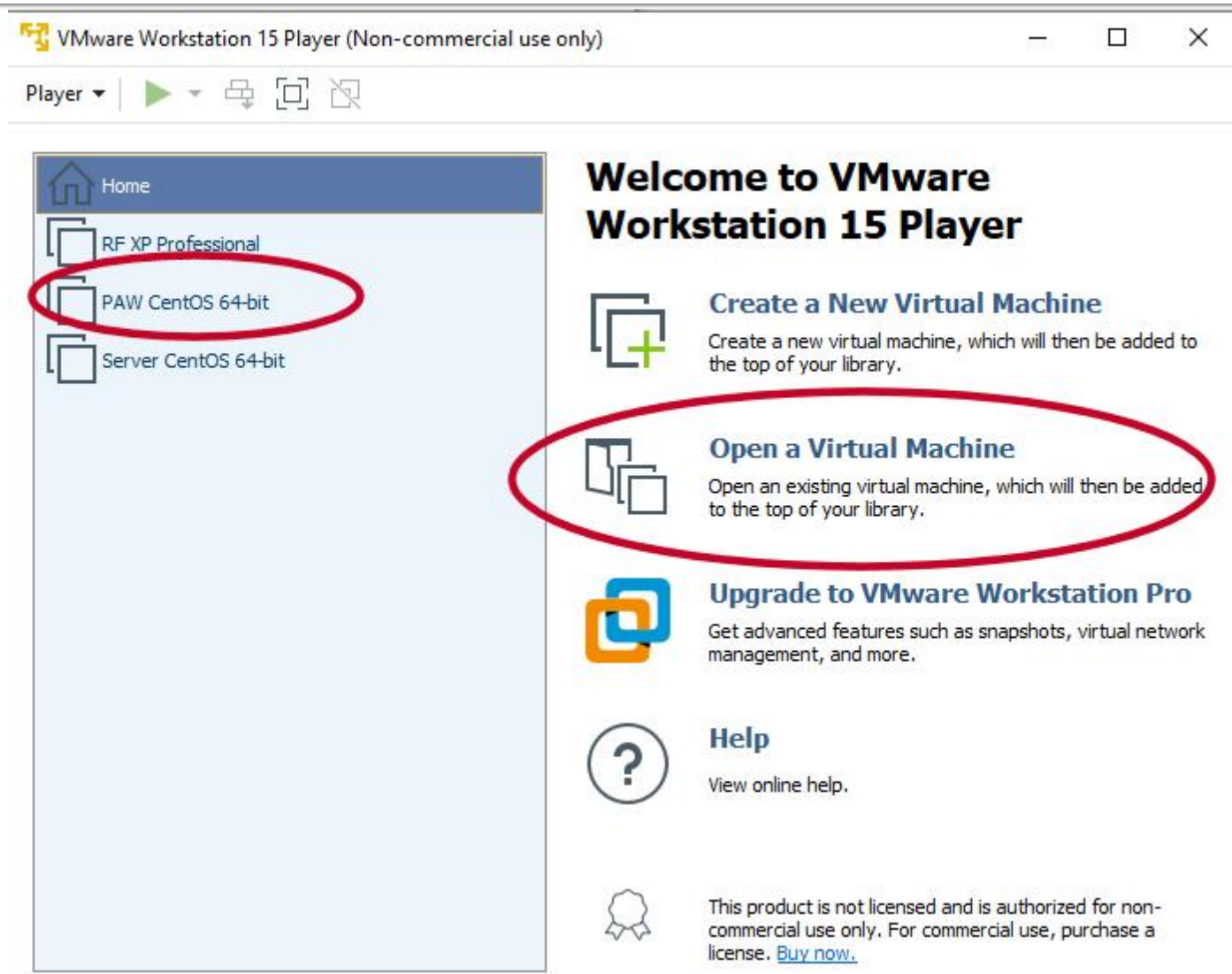

VMware Workstation 15 Player (Non-commercial use only)

Player | ▶ | 🖨️ | 📄 | 🗑️

Home

- RF XP Professional
- PAW CentOS 64-bit
- Server CentOS 64-bit

Welcome to VMware Workstation 15 Player

- Create a New Virtual Machine**
Create a new virtual machine, which will then be added to the top of your library.
- Open a Virtual Machine**
Open an existing virtual machine, which will then be added to the top of your library.
- Upgrade to VMware Workstation Pro**
Get advanced features such as snapshots, virtual network management, and more.
- Help**
View online help.

This product is not licensed and is authorized for non-commercial use only. For commercial use, purchase a license. [Buy now.](#)

Server referinta

- Pentru rularea unui server pe o versiune VMware Player **anterioara**:
 - se localizeaza fisierul "*.vmx" a server-ului
 - se modifica virtualHW.version = "**21**" la o valoare mai mica (anterioara)
 - in 2.13 -> **18?**

Server referinta

The image shows a Windows File Explorer window titled "Server Debian" with the address bar set to "Documents > Curs PAW". The file list includes several files related to Debian 12.x 64-bit, with "Debian 12.x 64-bit.vmx" circled in red. An overlapping text editor window shows the contents of this file, with lines 2 and 3 circled in red.

File Explorer File List:

Name	Size	Modified	Type
Debian 12.x 64-bit.nvram			
Debian 12.x 64-bit.scoreboard			
Debian 12.x 64-bit.vmdk			
Debian 12.x 64-bit.vmsd			
Debian 12.x 64-bit.vmx			
Debian 12.x 64-bit.vmxr			
Debian 12.x 64-bit.vmxs			
Debian 12.x 64-bit-0.scoreboard		21-Feb-24 09:45	VMXF
Debian 12.x 64-bit-1.scoreboard		04-Mar-24 14:35	SCORE
Debian 12.x 64-bit-2.scoreboard		04-Mar-24 14:23	SCORE
Debian 12.x 64-bit-3.scoreboard		04-Mar-24 13:18	SCORE

Text Editor Content (Debian 12.x 64-bit.vmx):

```
1 .encoding = "windows-1252"  
2 config.version = "8"  
3 virtualHW.version = "21"  
4 pciBridge0.present = "TRUE"  
5 pciBridge4.present = "TRUE"  
6 pciBridge4.virtualDev = "pcieRoot"  
7 pciBridge4.functions = "8"  
8 pciBridge5.present = "TRUE"  
9 pciBridge5.virtualDev = "pcieRoot"  
10 pciBridge5.functions = "8"  
11 pciBridge6.present = "TRUE"  
12 pciBridge6.virtualDev = "pcieRoot"  
13 pciBridge6.functions = "8"
```

Aplicatii suport

- WinSCP (client FTP, gratuit)
 - <https://winscp.net/eng/download.php>
- Notepad ++ (editor, avansat, gratuit)
 - <https://notepad-plus-plus.org/downloads/>
- Putty (remote access)
 - <https://www.putty.org/>
- MySQL Workbench (gratuit, cont Oracle)
 - <https://www.mysql.com/products/workbench/>
- Visual Studio Code (gratuit, Microsoft)
 - <https://code.visualstudio.com/download>

Aplicatii suport

- Variante portabile

Laboratory

[Laborator 1](#) (pdf, 1.48 MB, ro, 🇷🇴)

[Server Win2000 pentru VMWare Player - lab 1 \(cloud\)](#) (link, 0 Bytes, en, 🇺🇸)

[Accesorii laborator \(x32 - partial\)](#) (zip, 28.92 MB, en, 🇺🇸)

[Accesorii laborator \(x64 - complet\)](#) (zip, 133.58 MB, en, 🇺🇸)

Project/Design

[VMware Workstation Player](#) (link, 0 Bytes, en, 🇺🇸)

[Server CentOS pentru VMWare Player \(cloud\)](#) (link, 0 Bytes, en, 🇺🇸)

[Instalare Centos](#) (pdf, 2.54 MB, en, 🇺🇸)

[Server Ubuntu pentru VMWare Player \(cloud\)](#) (link, 0 Bytes, en, 🇺🇸)

[Instalare Ubuntu](#) (pdf, 1.82 MB, en, 🇺🇸)

Adresa IP

- login, ifconfig
- Ctrl + Alt + mouse

```
PAW CentOS 64-bit - VMware Workstation 15 Player (Non-commercial use only)
Player | || | | |
CentOS Linux 7 (Core)
Kernel 3.10.0-229.20.1.el7.x86_64 on an x86_64

tmpaw login: root
Password:
Last login: Wed Jun 17 05:35:16 from 192.168.0.106
[root@tmpaw ~]# ifconfig
```

```
PAW CentOS 64-bit - VMware Workstation 15 Player (Non-commercial use only)
Player | || | | |
CentOS Linux 7 (Core)
Kernel 3.10.0-229.20.1.el7.x86_64 on an x86_64

tmpaw login: root
Password:
Last login: Wed Jun 17 05:35:16 from 192.168.0.106
[root@tmpaw ~]# ifconfig
eno16777736: flags=4163<UP,BROADCAST,RUNNING,MULTICAST> mtu 1500
    inet 192.168.0.108 netmask 255.255.255.0 broadcast 192.168.0.255
    inet6 fe80::250:56ff:fe3e:1693 prefixlen 64 scopeid 0x20<link>
    ether 00:50:56:3e:16:93 txqueuelen 1000 (Ethernet)
    RX packets 104 bytes 12814 (12.5 KiB)
    RX errors 0 dropped 0 overruns 0 frame 0
    TX packets 99 bytes 11847 (11.5 KiB)
    TX errors 0 dropped 0 overruns 0 carrier 0 collisions 0

lo: flags=73<UP,LOOPBACK,RUNNING> mtu 65536
    inet 127.0.0.1 netmask 255.0.0.0
    inet6 ::1 prefixlen 128 scopeid 0x10<host>
    loop txqueuelen 0 (Local Loopback)
    RX packets 16 bytes 1774 (1.7 KiB)
    RX errors 0 dropped 0 overruns 0 frame 0
    TX packets 16 bytes 1774 (1.7 KiB)
    TX errors 0 dropped 0 overruns 0 carrier 0 collisions 0

[root@tmpaw ~]# _
```

Putty

- putty.exe
- evitare captura mouse, copy/paste etc.

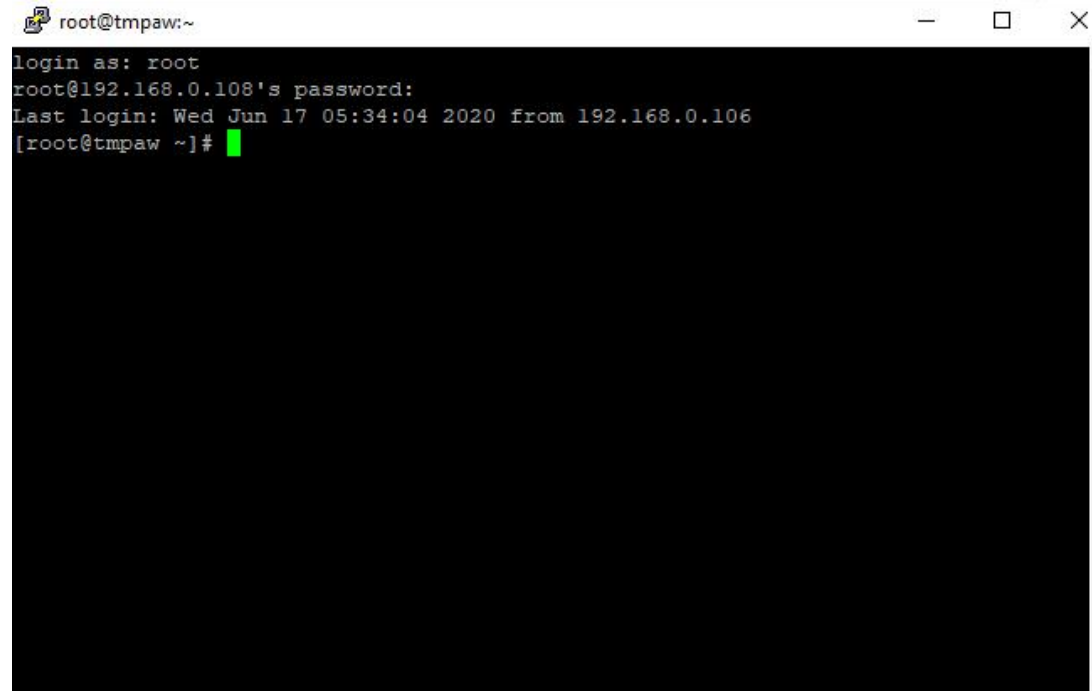
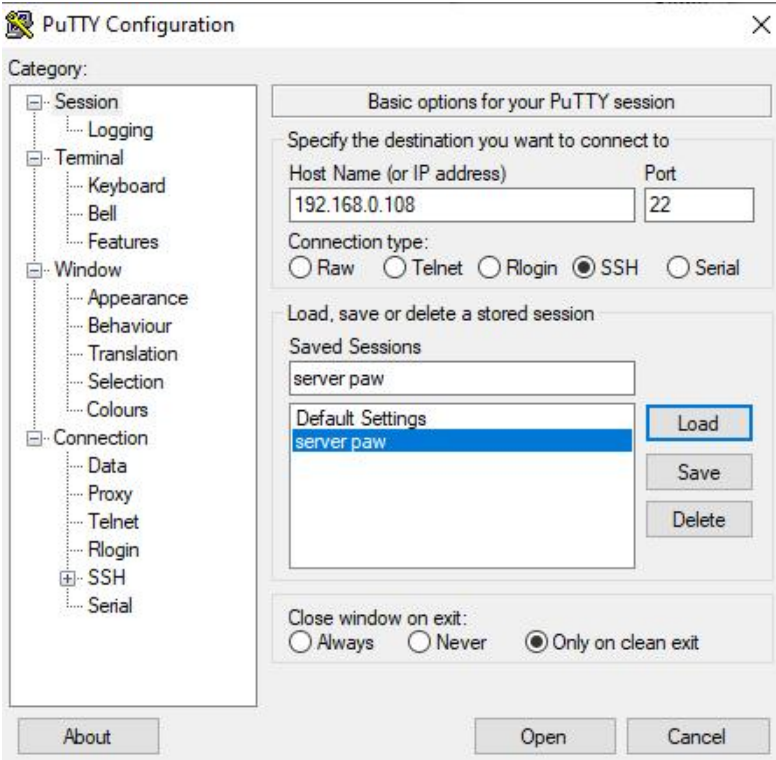

WinSCP

- client FTP
- upload fisiere

The screenshot displays the WinSCP application interface. On the left, a 'Session' dialog box is open, showing configuration for an SFTP connection to 192.168.0.108 on port 22, with the user 'student'. The 'Login' button is highlighted. The main window shows the remote file system structure, including a 'www/html' directory. A table on the right lists files in the current directory:

Name	Size	Changed	Rights
ap.log	1 KB	2/29/2016 11:28:50 AM	rw-rw-r
info.php	1 KB	9/30/2009 3:23:00 PM	rw-rw-r
logfile.php	4 KB	12/6/2015 12:05:08 PM	rw-rw-r
test.php	2 KB	2/29/2016 12:04:12 PM	rw-rw-r

The status bar at the bottom indicates '0 B of 5.09 KB in 0 of 4' and shows the connection type as 'SFTP-3' with a lock icon. The system tray shows the time as 1, 21:06:30.

Visual Studio Code

- 1.87 Portabil (curent 1.97.2)

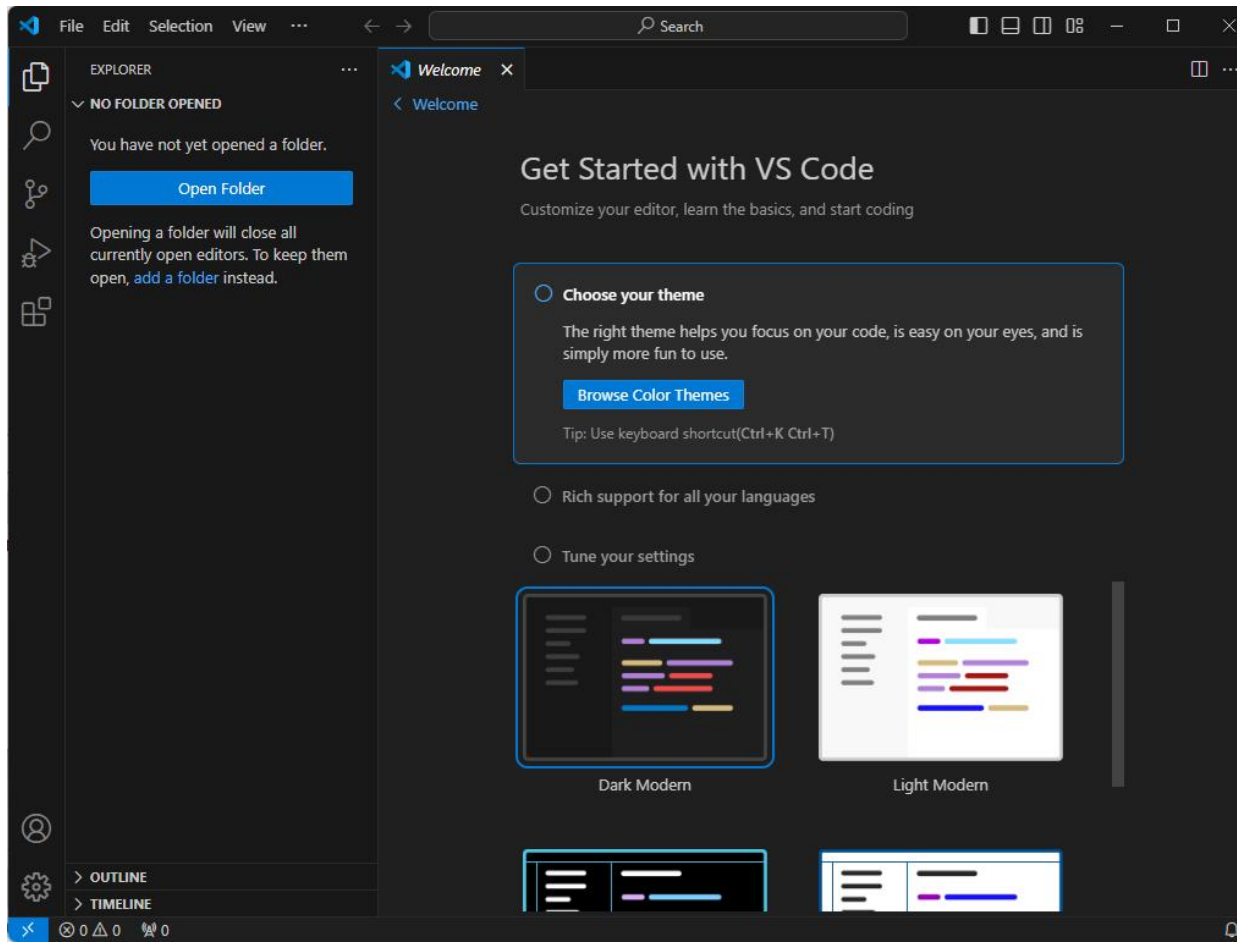

Visual Studio Code

- Extensii instalate
 - PHP Intelephense
 - PHP 8 -> Debian
 - PHP Debug (inactiv momentan)
 - SFTP – salvare automata pe un server

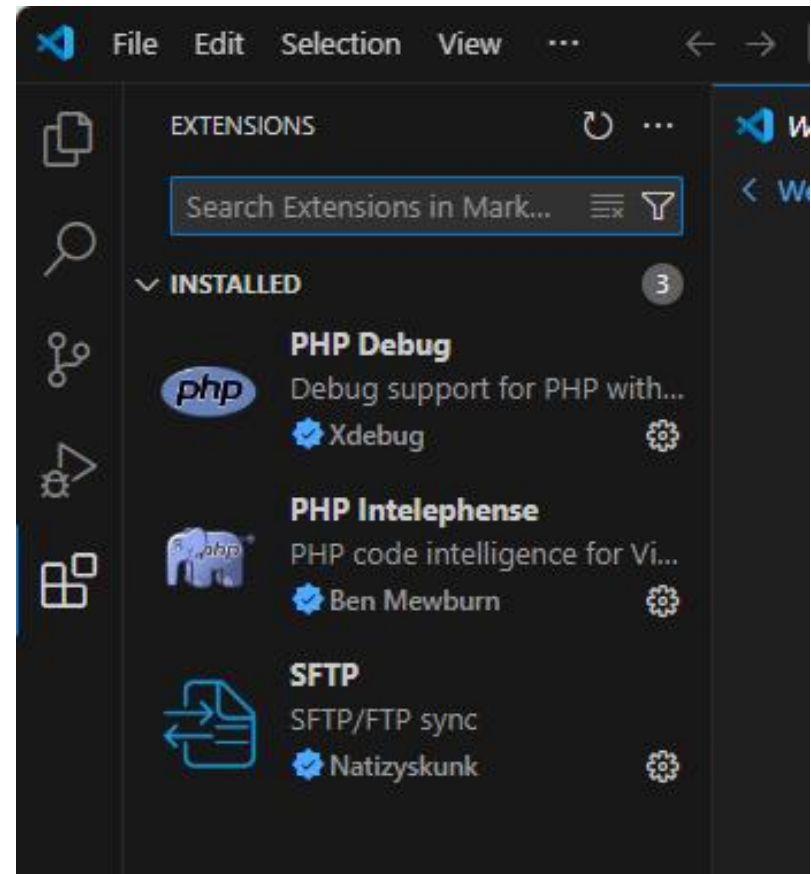

Visual Studio Code

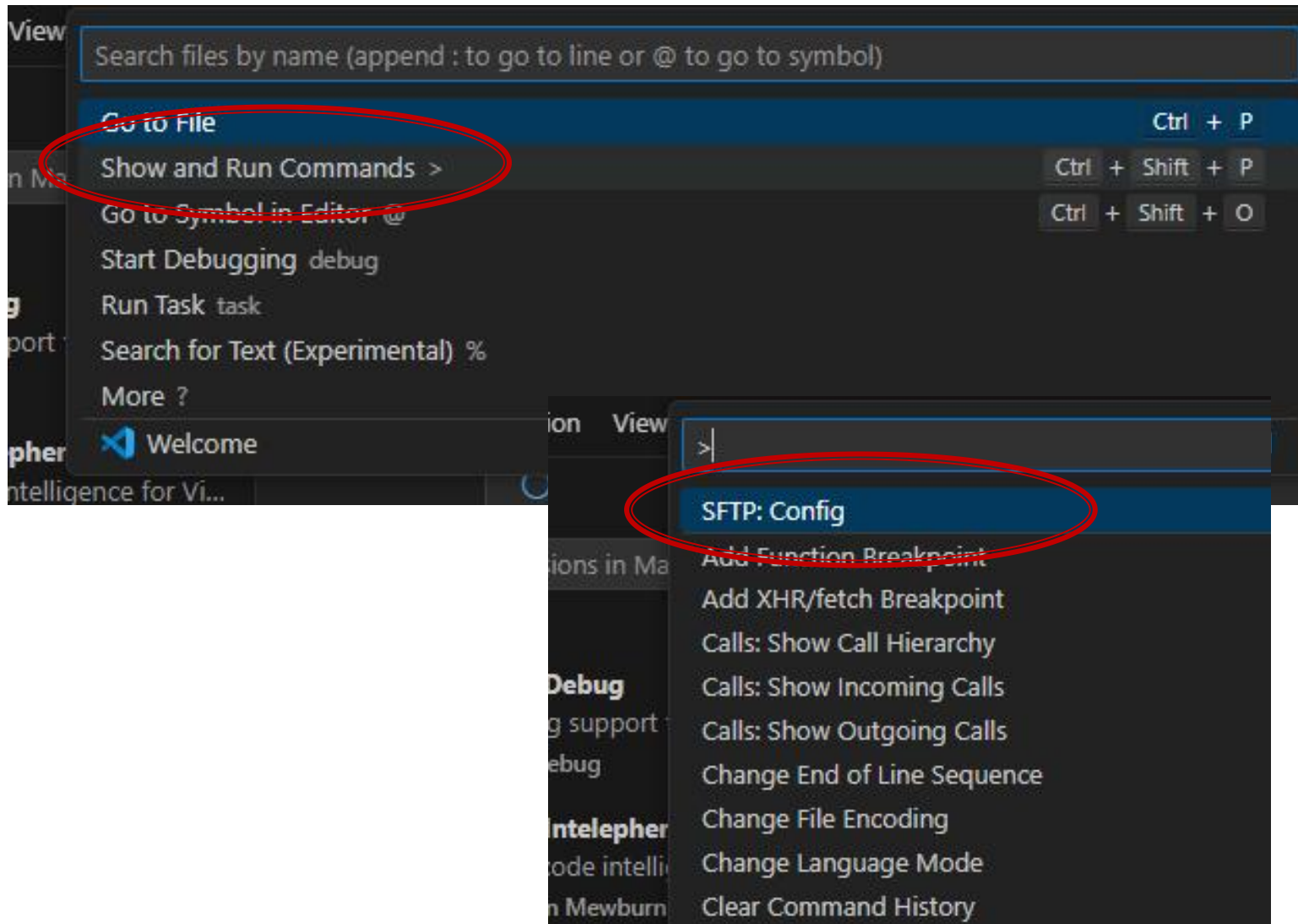

Visual Studio Code

```
{ } sftp.json x
.vscode > { } sftp.json > ...
1 {
2   "name": "My Server",
3   "host": "localhost",
4   "protocol": "sftp",
5   "port": 22,
6   "username": "username",
7   "remotePath": "/",
8   "uploadOnSave": false,
9   "useTempFile": false,
10  "openSsh": false
11 }
12
```

```
{ } sftp.json ●
.vscode > { } sftp.json > ...
1 {
2   "name": "Debian Server",
3   "host": "192.168.30.5",
4   "protocol": "sftp",
5   "port": 22,
6   "username": "student",
7   "remotePath": "/var/www/html/",
8   "uploadOnSave": true,
9   "useTempFile": false,
10  "openSsh": false
11 }
12
```

Browser

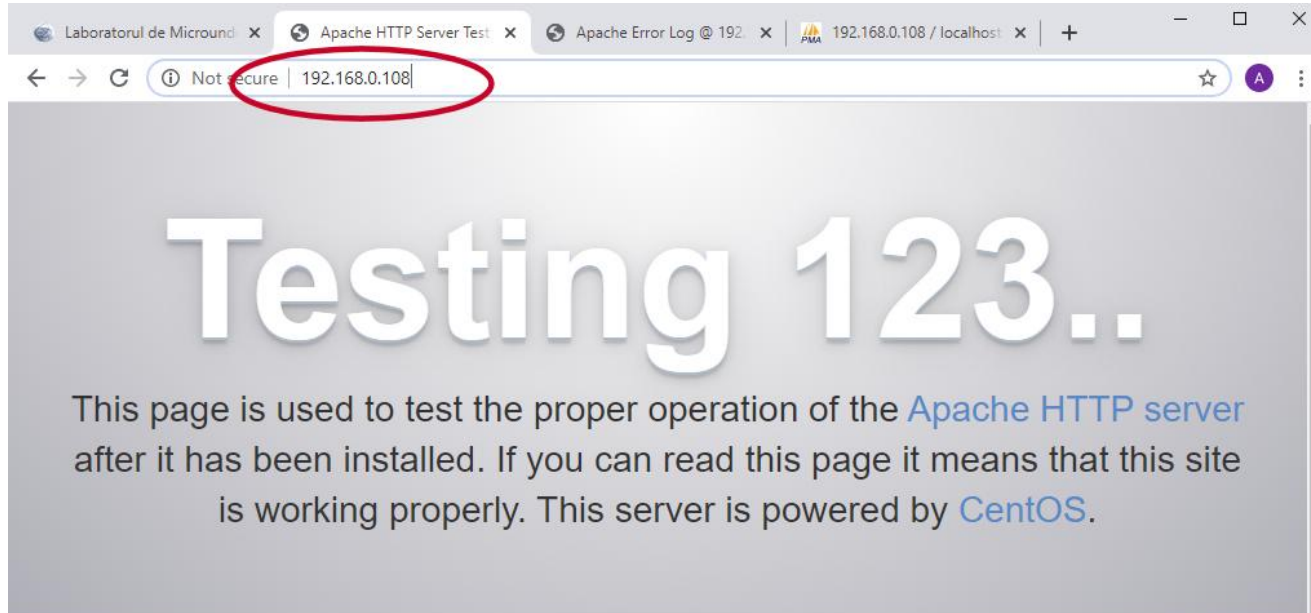

Just visiting?

The website you just visited is either experiencing problems or is undergoing routine maintenance.

If you would like to let the administrators of this website know that you've seen this page instead of the page you expected, you should send them e-mail. In general, mail sent to the name "webmaster" and directed to the website's domain should reach the appropriate person.

For example, if you experienced problems while visiting `www.example.com`, you should send e-mail to "webmaster@example.com".

Are you the Administrator?

You should add your website content to the directory `/var/www/html/`.

To prevent this page from ever being used, follow the instructions in the file `/etc/httpd/conf.d/welcome.conf`.

Promoting Apache and CentOS

You are free to use the images below on Apache and CentOS Linux powered HTTP servers. Thanks for using Apache and CentOS!



Server MySQL/MariaDB

The screenshot displays the phpMyAdmin web interface in a browser window. The address bar shows the URL `192.168.0.108/phpmyadmin/...`, which is circled in red. The interface includes a sidebar with a database tree and a main content area with several settings panels.

General Settings

- Change password
- Server connection collation: `utf8mb4_unicode_ci`

Appearance Settings

- Language: `English`
- Theme: `pmahomme`
- Font size: `82%`
- More settings

Database server

- Server: Localhost via UNIX socket
- Server type: MariaDB
- Server version: 5.5.44-MariaDB - MariaDB Server
- Protocol version: 10
- User: root@localhost
- Server charset: UTF-8 Unicode (utf8)

Web server

- Apache/2.4.6 (CentOS) OpenSSL/1.0.1e-fips mod_fcgid/2.3.9 PHP/5.4.16 mod_python/3.5.0- Python/2.7.5
- Database client version: libmysql - 5.5.44-MariaDB
- PHP extension: mysql
- PHP version: 5.4.16

phpMyAdmin

- Version information: 4.4.15.1
- Documentation
- Wiki
- Official Homepage
- Contribute
- Get support
- List of changes

MySql – Server Ubuntu/Debian

Mini – Indrumar practic

Lucru cu bazele de date

Utilizzare LAMP Ubuntu/Debian

1. login → **paw**:masteretti
2. (su - + **root**:masteretti) ifconfig → 192.168.30.5
3. putty.exe → 192.168.30.5 → SSH → **paw**:masteretti (remote login + su -/sudo)
4. [alte comenzi linux dorite]
5. FTP → Winscp → SFTP → student:masterrc@192.168.30.5
6. MySql → http://192.168.30.5/phpmyadmin → **root**:masteretti
7. Apache Error Log →
 - 7a. putty → nano /var/log/httpd/error_log
 - 7b. http://192.168.30.5/logfile.php (nonstandard)
8. PHP info → http://192.168.30.5/info.php

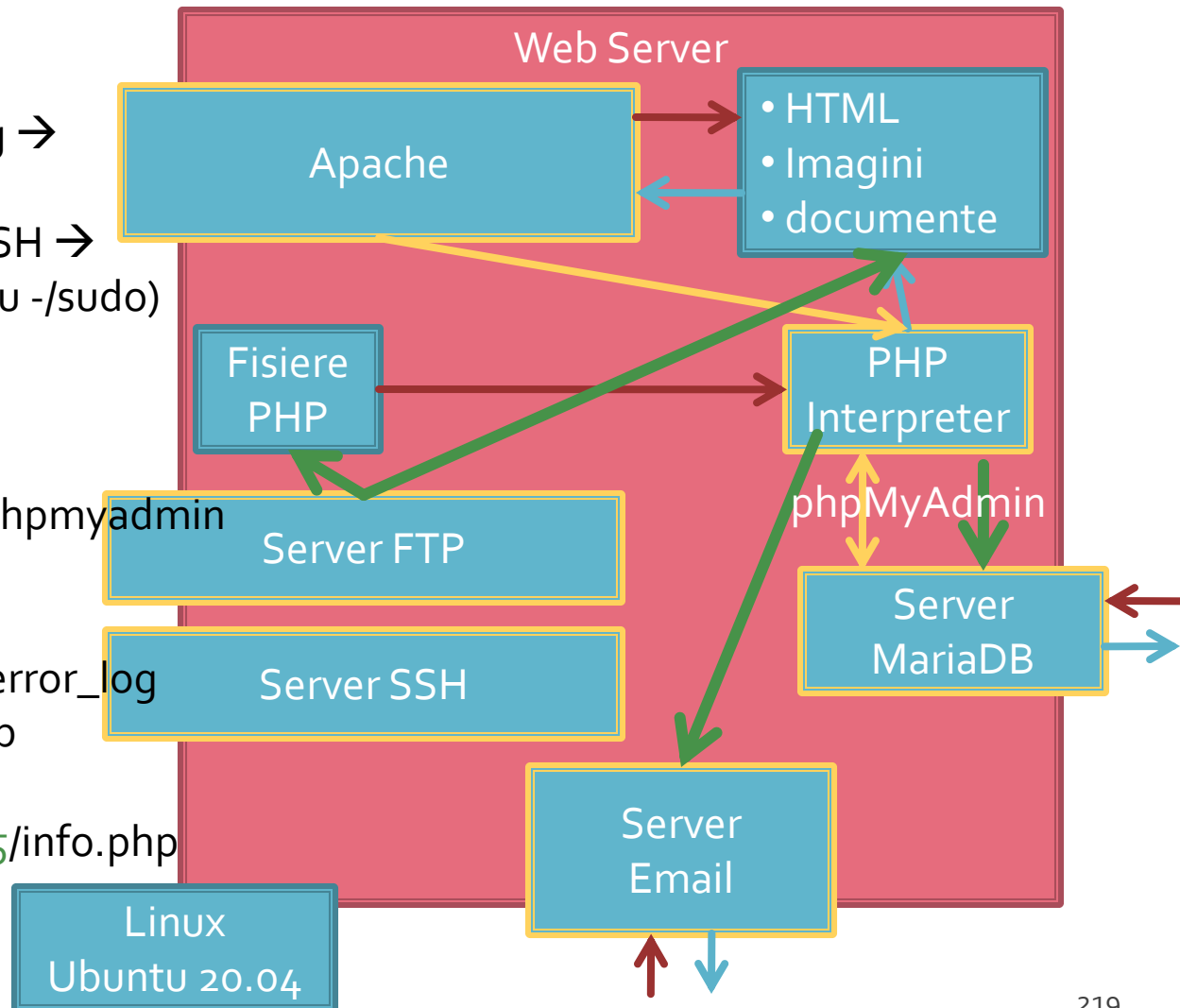

PhpMyAdmin

- <http://192.168.203.128/phpmyadmin>
 - root
 - parola administrator **MySQL/MariaDB** (masteretti)

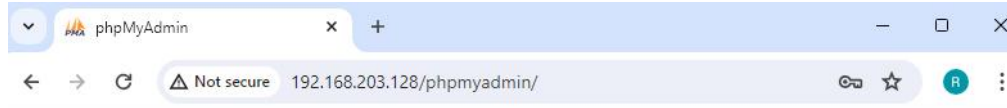

Welcome to phpMyAdmin

Language

English

Log in

Username: root

Password:

Log in

PhpMyAdmin

The screenshot displays the phpMyAdmin web interface in a browser window. The address bar shows the URL `192.168.203.128/phpmyadmin/index.php?route=/&route=%2F`. The interface includes a top navigation bar with tabs for Databases, SQL, Status, User accounts, Export, Import, Settings, Replication, Variables, Charsets, and More. A left sidebar shows a tree view of databases: information_schema, mysql, performance_schema, phpmyadmin, sys, and world. The main content area is divided into several panels:

- General settings:** Includes a "Change password" link, "Server connection collation" set to `utf8mb4_unicode_ci`, and a "More settings" link.
- Appearance settings:** Includes "Language" set to `English` and "Theme" set to `pmahomme` with a "View all" button.
- Database server:** Lists server details:
 - Server: Localhost via UNIX socket
 - Server type: MariaDB
 - Server connection: SSL is not being used
 - Server version: 10.11.6-MariaDB-0+deb12u1 - Debian 12
 - Protocol version: 10
 - User: root@localhost
 - Server charset: UTF-8 Unicode (utf8mb4)
- Web server:** Lists web server details:
 - Apache/2.4.57 (Debian)
 - Database client version: libmysql - mysqlnd 8.2.7
 - PHP extension: mysqli, curl, mbstring, sodium
 - PHP version: 8.2.7
- phpMyAdmin:** Lists version and resource information:
 - Version information: 5.2.1deb1
 - Documentation
 - Official Homepage
 - Contribute
 - Get support
 - List of changes
 - License

Creare Baza de Date

- Databases → "nume" → Create

The screenshot shows the phpMyAdmin interface for creating a new database. The 'Databases' menu item is circled in red. Below it, the 'Create database' form is shown with the name 'lab' and collation 'utf8mb4_general_ci' circled in red. The 'Create' button is also circled in red. A table of existing databases is visible below the form.

Database	Collation	Action
<input type="checkbox"/> information_schema	utf8mb3_general_ci	Check privileges
<input type="checkbox"/> mysql	utf8mb4_general_ci	Check privileges
<input type="checkbox"/> performance_schema	utf8mb3_general_ci	Check privileges
<input type="checkbox"/> phpmyadmin	utf8mb4_general_ci	Check privileges
<input type="checkbox"/> sys	utf8mb3_general_ci	Check privileges
<input type="checkbox"/> world	utf8mb4_general_ci	Check privileges

Total: 6

Creare tabelle in baza de date

- Baza de date (in lista) → Structure → div Create new table → nume/coloane → Create

The screenshot shows the phpMyAdmin web interface. The browser address bar displays the URL: 192.168.203.128/phpmyadmin/index.php?route=/database/structure&db=lab. The interface includes a navigation menu on the left with a tree view of databases: New, information_schema, lab, mysql, performance_schema, phpmyadmin, and sys. The 'lab' database is selected and highlighted. The main content area shows the 'Structure' tab for the 'lab' database, which currently contains no tables. A 'Create new table' button is visible. Below this, a form is used to define a new table: the 'Table name' field contains 'categorii' and the 'Number of columns' field contains '3'. A 'Create' button is located to the right of the form. Red circles highlight the 'Structure' tab, the 'Create new table' button, the 'lab' database in the left sidebar, the 'categorii' table name, the '3' in the number of columns field, and the 'Create' button.

Introducere coloane, tabel categorii

- (eventual) Adaugare coloane / Stabilire nume
- Name / Type / Length / Default

The screenshot shows the phpMyAdmin interface for a database named 'lab'. The table 'categorii' is selected, and the 'Structure' tab is active. The table structure is displayed as follows:

Name	Type	Length/Values	Default	Collation	Attributes	Null	Index	Comments
d_categ	INT		None			<input type="checkbox"/>	PRIMARY	<input checked="" type="checkbox"/>
nume	VARCHAR	45	As defined:			<input type="checkbox"/>	---	<input type="checkbox"/>
detalii	VARCHAR	150	None			<input checked="" type="checkbox"/>	---	<input type="checkbox"/>

At the top of the interface, the 'Table name:' field contains 'categorii', and the 'Add' button is set to '1 column(s)'. The 'Storage Engine' is set to 'InnoDB'.

Introducere coloane

- (eventual) NOT NULL / Index / Auto Increment

Server: localhost:3306 » Database: lab

Structure SQL Search Query Export Import Operations Privileges Routines Events Triggers Tracking More

Table name: categorii Add 1 column(s) Go

Name	Type	Length/Values	Default	Collation	Attributes	Null	Index	Comments
id_categ	INT		None			<input type="checkbox"/>	PRIMARY	<input checked="" type="checkbox"/>
nume	VARCHAR	45	As defined:			<input type="checkbox"/>	---	
detalii	VARCHAR	150	None			<input checked="" type="checkbox"/>	---	

Table comments: Collation: Storage Engine: InnoDB

Preview SQL

- in aproape toate etapele in PhpMyAdmin
 - exemplu de cod SQL/schelet utilizabil (copy/paste) in aplicatia PHP
 - modificari de finete absente din interfata
 - copy → Sectiune "SQL" in interfata → paste → modificare

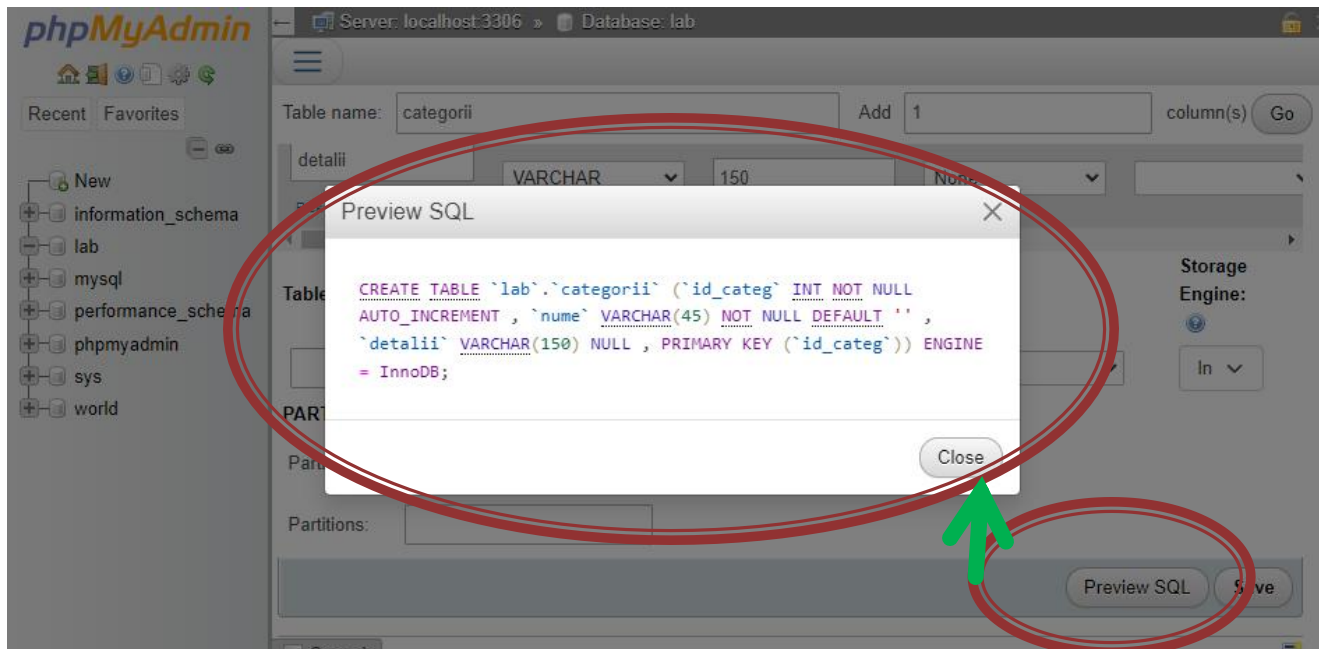

Introducere coloane, tabel produse

- New → Nume → Add Columns → ...

The screenshot shows the phpMyAdmin interface with the 'Add Columns' dialog open for a table named 'produse'. The dialog has a table with columns for Name, Type, Length/Values, Default, Collation, Attributes, Null Index, and Comments. The 'id_produs' column is highlighted as the primary key. The 'nume' column is highlighted with a red oval, indicating it is the column being added. The 'Add 1 column(s) Go' button is also highlighted with a red oval. The 'New' button in the left sidebar is also highlighted with a red oval.

Name	Type	Length/Values	Default	Collation	Attributes	Null	Index	Comments
id_produs	INT		None			<input type="checkbox"/>	PRIMARY	<input checked="" type="checkbox"/>
id_categ	INT		None			<input type="checkbox"/>	---	<input type="checkbox"/>
nume	VARCHAR	45	As defined:			<input type="checkbox"/>	---	<input type="checkbox"/>
detalii	VARCHAR	150	None			<input checked="" type="checkbox"/>	---	<input type="checkbox"/>
cant	INT		None			<input checked="" type="checkbox"/>	---	<input type="checkbox"/>
pret	FLOAT		None			<input checked="" type="checkbox"/>	---	<input type="checkbox"/>

Introducere date initiale (interfata)

- Tabel → Insert → Completare → Go

The screenshot shows the phpMyAdmin interface for the 'lab' database, specifically the 'categorii' table. The 'Insert' button is circled in red. The 'name' field is filled with 'papetarie' and circled in red. The 'Insert as new row' dropdown is circled in red. The 'Go' button is circled in red. The 'Continue insertion with' field is set to '1' and circled in red.

Column	Type	Function	Null	value
id_categ	int(11)			
nume	varchar(45)			papetarie
detalii	varchar(150)		<input checked="" type="checkbox"/>	

Insert as new row and then Insert another new row

Continue insertion with 1 rows

Vizualizare date existente

- Tabel → Browse → salt la pagina (numar de linii pe pagina)

The screenshot shows the phpMyAdmin interface for a database named 'lab'. The 'categoriasii' table is selected in the left sidebar. The 'Browse' button is highlighted in the top navigation bar. The main content area displays the table structure and data. The table has three columns: 'id_categ', 'nume', and 'descriere'. The data rows are:

id_categ	nume	descriere
1	papetarie	NULL
2	instrumente	NULL
3	audio-video	NULL

The 'Browse' button and the table data are circled in red. The 'id_categ' column is also circled in red.

Introducere date initiale (SQL)

- Tabel → SQL → completare → Go

The screenshot shows the phpMyAdmin interface for the 'produse' table. The 'SQL' tab is selected, and the following INSERT query is entered:

```
1 INSERT INTO `produse` (`id_produș`, `id_categ`, `nume`, `detalii`, `cant`, `pret`) VALUES
2 (1, 'carte', 'mai multe pagini scrise legate', 0, 100),
3 (2, 1, 'caiet', 'mai multe pagini goale legate', 0, 75),
4 (3, 1, 'hartie scris', 'mai multe pagini goale NElegate', 0, 50),
5 (4, 2, 'penar', 'loc de depozitat instrumente de scris', 0, 150),
6 (5, 2, 'stilou', 'instrument de scris albastru', 0, 125),
7 (6, 2, 'creion', 'instrument de scris gri', 0, 25),
8 (7, 3, 'cd', 'canta', 0, 50),
9 (8, 3, 'dvd', 'vizual', 0, 100),
10 (9, 3, 'blue ray', 'vizual extrem', 0, 500);
```

The 'Go' button at the bottom right is highlighted, indicating the execution of the query.

Tabel produse

The screenshot shows the phpMyAdmin interface for a MySQL database named 'lab'. The current view is the 'produse' table. The interface includes a navigation sidebar on the left, a top navigation bar with tabs like 'Browse', 'Structure', 'SQL', 'Search', 'Insert', 'Export', 'Import', 'Privileges', and 'Operations', and a main content area displaying the table data. The 'Browse' tab is selected, and the table data is shown in a grid format. The 'categoriasii' and 'produse' items in the left sidebar are circled in red. The table data is as follows:

	id_produc	id_categ	nume	detalii	cant	pret
<input type="checkbox"/> Edit Copy Delete	1	1	carte	mai multe pagini scrise legate	0	100
<input type="checkbox"/> Edit Copy Delete	2	1	caiet	mai multe pagini goale legate	0	75
<input type="checkbox"/> Edit Copy Delete	3	1	hartie scris	mai multe pagini goale NElegate	0	50
<input type="checkbox"/> Edit Copy Delete	4	2	penar	loc de depozitat instrumente de scris	0	150
<input type="checkbox"/> Edit Copy Delete	5	2	stilou	instrument de scris albastru	0	125
<input type="checkbox"/> Edit Copy Delete	6	2	creion	instrument de scris gri	0	25
<input type="checkbox"/> Edit Copy Delete	7	3	cd	canta	0	50
<input type="checkbox"/> Edit Copy Delete	8	3	dvd	vizual	0	100
<input type="checkbox"/> Edit Copy Delete	9	3	blue ray	vizual extrem	0	500

Adaugare utilizator

- Server → User accounts → Add user account

The screenshot shows the phpMyAdmin interface with several elements circled in red to highlight the navigation path:

- The top navigation bar shows "Server: localhost:3306" circled.
- The "User accounts" menu item in the top navigation bar is circled.
- The "Add user account" button in the "New" section is circled.

The "User accounts overview" table is displayed below the navigation bar:

User name	Host name	Password	Global privileges	User group	Grant	Action
<input type="checkbox"/> mariadb.sys	localhost	No	USAGE		No	Edit privileges Export Unlock
<input type="checkbox"/> mysql	localhost	Yes	ALL PRIVILEGES	Yes		Edit privileges Export Lock
<input type="checkbox"/> phpmyadmin	localhost	Yes	USAGE	No		Edit privileges Export Lock
<input type="checkbox"/> root	localhost	Yes	ALL PRIVILEGES	Yes		Edit privileges Export Lock
<input type="checkbox"/> web	%	Yes	USAGE	No		Edit privileges Export Lock

Below the table, there are options to "Check all" and "With selected: Export". At the bottom, there are buttons for "New", "Add user account", and "Remove selected user accounts".

Adaugare utilizator

- Nu e recomandabil/**posibil** sa se utilizeze user-ul MySql "root" pentru aplicatii

The screenshot shows the phpMyAdmin interface for adding a new user account. The browser address bar indicates the URL: 192.168.203.128/phpmyadmin/index.php?route=/server/privileges&adduser=1. The page title is "Add user account". The form is titled "Login Information" and contains the following fields:

- User name: A text input field containing "lab_user".
- Host name: A dropdown menu set to "Any host".
- Password: A text input field with masked characters (dots).
- Re-type: A second text input field for password confirmation, also masked.
- Authentication plugin: A dropdown menu set to "Native MySQL authentication".
- Generate password: A button labeled "Generate" and an empty text input field.

Three red circles are drawn around the "User name" field, the "Host name" dropdown, and the "Password" field, highlighting these specific input areas.

Drepturi de acces

- Server → User accounts → Edit Privileges

The screenshot shows the phpMyAdmin interface for a MySQL server at localhost:3306. The breadcrumb navigation path is 'Server: localhost:3306' → 'User accounts'. The 'User accounts overview' page displays a table of user accounts with columns for User name, Host name, Password, Global privileges, User group, Grant, and Action. The 'Action' column for the 'lab_user' account has 'Edit privileges' circled in red.

	User name	Host name	Password	Global privileges	User group	Grant	Action
<input type="checkbox"/>	lab_user	%	Yes	USAGE	No	No	Edit privileges Export Lock
<input type="checkbox"/>	mariadb.sys	localhost	No	USAGE	No	No	Edit privileges Export Unlock
<input type="checkbox"/>	mysql	localhost	Yes	ALL PRIVILEGES	Yes	Yes	Edit privileges Export Lock
<input type="checkbox"/>	phpmyadmin	localhost	Yes	USAGE	No	No	Edit privileges Export Lock
<input type="checkbox"/>	root	localhost	Yes	ALL PRIVILEGES	Yes	Yes	Edit privileges Export Lock
<input type="checkbox"/>	web	%	Yes	USAGE	No	No	Edit privileges Export Lock

↑ Check all With selected: [Export](#)

Drepturi de acces

- Database → nume → Go

The screenshot shows the phpMyAdmin interface for editing privileges for the user 'lab_user'. The top navigation bar includes buttons for 'Databases', 'SQL', 'Status', 'User accounts', and 'Export'. The 'Database' button is circled in red. Below the navigation bar, the page title is 'Edit privileges: User account 'lab_user''.

The main content area is titled 'Database-specific privileges'. It contains a table with the following structure:

Database	Privileges	Grant	Table-specific privileges	Action
None				

Below the table, there is a section for 'Add privileges on the following database(s):'. A dropdown menu is open, showing a list of databases: 'lab', 'mysql', 'phpmyadmin', and 'sys'. The 'lab' database is selected and circled in red.

At the bottom of the page, there is a 'Go' button, which is also circled in red.

Drepturi de acces

- Se alocă drepturile SELECT + INSERT + UPDATE + DELETE asupra bazei de date create

The screenshot shows the phpMyAdmin interface for editing privileges. The browser address bar shows the URL: `192.168.203.128/phpmyadmin/index.php?route=/server/privileges&username=lab_user&hostname=%25&dbname=`. The page title is "Edit privileges: User account 'lab_user'@'%' Database lab". The "Database-specific privileges" section is active, and the "Check all" checkbox is unchecked. The "Data" category is selected, and the following privileges are checked: SELECT, INSERT, UPDATE, and DELETE. The "Structure" and "Administration" categories are not selected.

Category	Privilege	Checked
Data	SELECT	<input checked="" type="checkbox"/>
	INSERT	<input checked="" type="checkbox"/>
	UPDATE	<input checked="" type="checkbox"/>
	DELETE	<input checked="" type="checkbox"/>
Structure	CREATE	<input type="checkbox"/>
	ALTER	<input type="checkbox"/>
	INDEX	<input type="checkbox"/>
	DROP	<input type="checkbox"/>
	CREATE TEMPORARY TABLES	<input type="checkbox"/>
	SHOW VIEW	<input type="checkbox"/>
	CREATE ROUTINE	<input type="checkbox"/>
	ALTER ROUTINE	<input type="checkbox"/>
	EXECUTE	<input type="checkbox"/>
	TRIGGER	<input type="checkbox"/>
Administration	GRANT	<input type="checkbox"/>
	LOCK TABLES	<input type="checkbox"/>
	REFERENCES	<input type="checkbox"/>

Drepturi de acces, verificare

- Nume → Privileges
- Marea majoritate a aplicatiilor **nu** au nevoie de drepturi de acces la structura/administrare

The screenshot shows the phpMyAdmin interface for a MySQL server. The browser address bar indicates the URL: `192.168.203.128/phpmyadmin/index.php?route=/server/privileges&db=lab&checkprivsdb=lab&viewing_mode=db`. The interface title is "Server: localhost:3306 > Database: lab". The "Privileges" tab is selected and circled in red. The left sidebar shows a tree view of databases, with "lab" selected and circled in red. The main content area displays a table titled "Users having access to 'lab'".

User name	Host name	Type	Privileges	Grant	Action
<input type="checkbox"/> lab_user	%	database-specific	SELECT, INSERT, UPDATE, DELETE	No	Edit privileges Export
<input type="checkbox"/> mysql	localhost	global	ALL PRIVILEGES	Yes	Edit privileges Export
<input type="checkbox"/> root	localhost	global	ALL PRIVILEGES	Yes	Edit privileges Export

Below the table, there is a "Check all" checkbox and an "Export" button for the selected entries.

Index

- Adaugare index e esentiala pentru viteza
 - exemplu, produse grupate pe categorii, selectia produselor dintr-o categorie se face cu :
 - `SELECT * FROM `produse` WHERE `id_categ` = 1`
- Tabel → Structure → Index / Selectare + Index

The screenshot shows the phpMyAdmin interface for a table named 'produse' in a database named 'lab'. The table structure is displayed in 'Table structure' view. A new index has been added to the 'id_categ' column, which is highlighted with a red circle. The index is named 'INDEX(`id_categ`)' and is located at the bottom of the table structure. The table structure table is as follows:







#	Name	Type	Collation	Attributes	Null	Default	Comments	Extra	Action
1	id_produs	int(11)			No	None		AUTO_INCREMENT	Change Drop More
2	id_categ	int(11)			No	None			Change Drop More
3	nume	varchar(45)	utf8mb4_general_ci		No				Change Drop More
4	detalii	varchar(150)	utf8mb4_general_ci		Yes	NULL			Change Drop More
5	cant	int(11)			Yes	NULL			Change Drop More
6	pret	float			Yes	NULL			Change Drop More

At the bottom of the interface, the index type selection menu is visible, with 'Index' selected and highlighted with a green circle. Other options include Primary, Unique, Spatial, and Fulltext.

Verificare/Stergere index

- Zona Indexes, vizualizare/control lista de indecsi

Indexes

Action	Keyname	Type	Unique	Packed	Column	Cardinality	Collation	Null	Comment
 Edit  Rename  Drop	PRIMARY	BTREE	Yes	No	id_produ	9	A	No	
 Edit  Rename  Drop	id_categ	BTREE	No	No	id_categ	9	A	No	

Backup, Restore

- Ca și în cazul Windows facilitatea de Backup realizează un script SQL care conține structura și datele exprimate sub forma de interogări SQL
- O deosebire între PhpMyAdmin și aplicațiile specifice MySQL (aceleși de pe Windows 2000 sau MySQL Workbench) este absența liniilor de creare a bazei de date
 - CREATE DATABASE IF NOT EXISTS lab;
 - USE lab;
- La utilizarea PhpMyAdmin trebuie să se creeze manual baza de date înaintea restaurării

Backup

- Nume (tabel sau baza de date) → Export
 - Custom: exista optiunea Add CREATE DATABASE / USE statement

The screenshot displays the phpMyAdmin interface for a MySQL server at localhost:3306, connected to the 'lab' database. The 'Export' menu item in the top navigation bar is circled in red. In the left sidebar, the 'lab' database is selected and also circled in red. The main content area is titled 'Exporting tables from "lab" database'. Under the 'Export templates:' section, the 'New template:' area has a 'Template name' input field and a 'Create' button. The 'Existing template:' area has a dropdown menu labeled '-- Select a template'. Under the 'Export method:' section, the 'Custom - display all possible options' radio button is selected and circled in red, while the 'Quick - display only the minimal options' radio button is unselected.

Restore

- Se creaza in avans baza de date
- Nume → Import → Browse (alegere fisier backup)
- fisierele SQL pot fi compresate gzip, bzip2, zip

The screenshot displays the phpMyAdmin interface. On the left, the database structure tree shows a database named 'lab' selected and circled in red. The main panel shows the 'Import' dialog for the 'lab' database. The 'Import' button in the top toolbar is also circled in red. The dialog includes a 'File to import:' section with a text box containing 'lab.sql', which is circled in red. Below this, there is a 'Choose File' button and a file selection area. The dialog also provides instructions on file compression and a file size limit of 2,048KiB.

Structure SQL Search Query Export **Import** Operat

Importing into the database "lab"

File to import:

File may be compressed (gzip, bzip2, zip) or uncompressed.
A compressed file's name must end in `.[format].[compression]`. Example: `.sql.zip`

Browse your computer: (Max: 2,048KiB)

Choose File lab.sql

You may also drag and drop a file on any page.

Character set of the file:

MySQL Workbench

Mini – Indrumar practic

Lucru cu bazele de date

MySQL Workbench CE

- <https://dev.mysql.com/downloads/workbench/>



General Availability (GA) Releases Archives ⓘ

MySQL Workbench 8.0.36

Select Operating System:
Microsoft Windows

Recommended Download:

MySQL Installer
for Windows

All MySQL Products. For All Windows Platforms.
In One Package.

Starting with MySQL 5.6 the MySQL Installer package replaces the standalone MSI packages.

Windows (x86, 32 & 64-bit), MySQL Installer MSI [Go to Download Page >](#)

Other Downloads:

Windows (x86, 64-bit), MSI Installer <small>(mysql-workbench-community-8.0.36-winx64.msi)</small>	8.0.36	42.0 MB	Download
			<small>MD5: 2156fe0cb6f5ed83908e4631006390a Signature</small>

MySQL Workbench CE

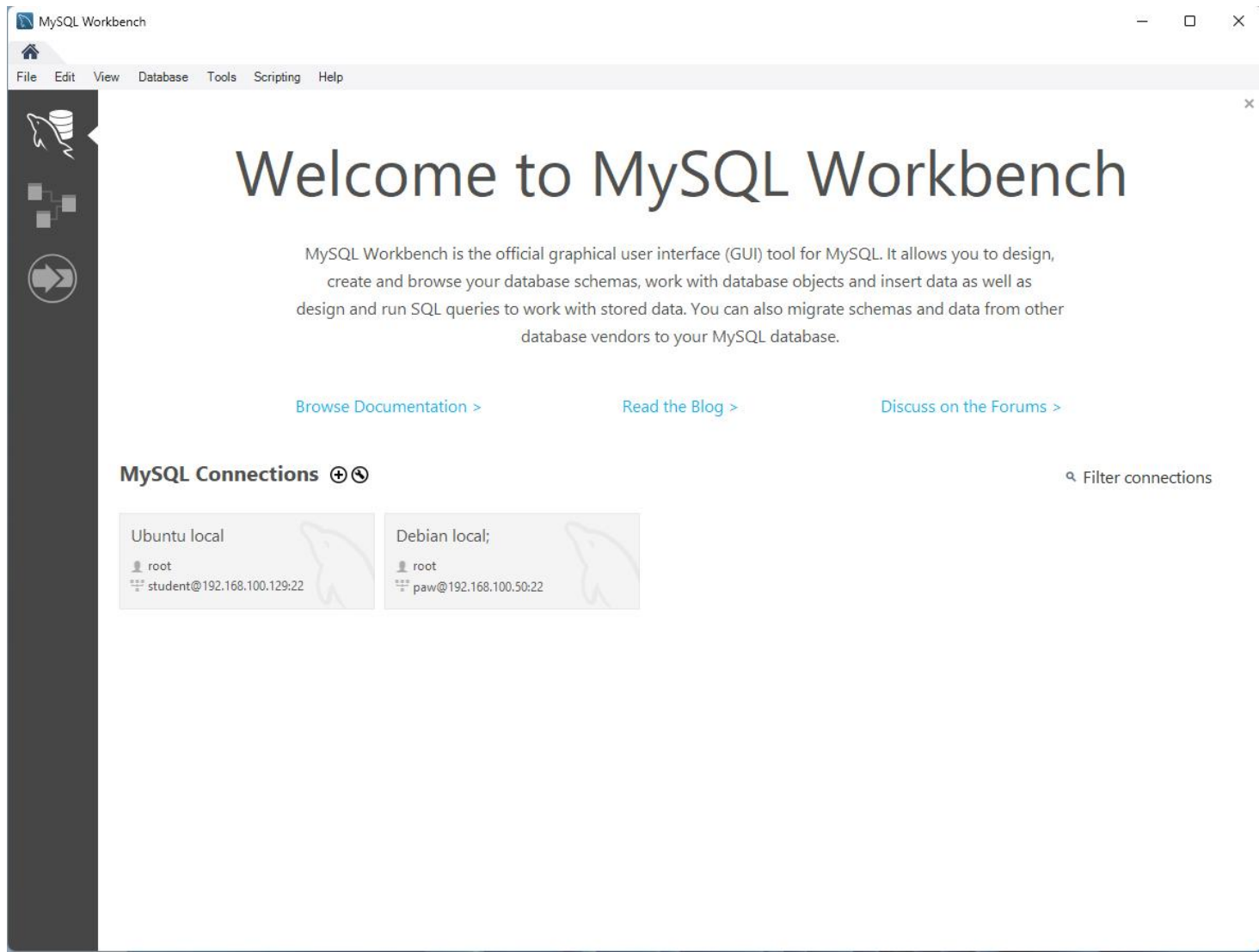

Conexiune

welcom

MySQL Workbench i
create and brows
design and run SQL q

[Browse Documentat...](#)

MySQL Connections  

Setup New Connection

Connection Name: Debian Dev Type a name for the connection

Connection Method: Standard TCP/IP over SSH Method to use to connect to the RDBMS

Parameters SSL Advanced

SSH Hostname: 192.168.203.128:22 SSH server hostname, with optional port number.

SSH Username: paw Name of the SSH user to connect with.

SSH Password: Store in Vault ... Clear SSH user password to connect to the SSH tunnel.

SSH Key File: Path to SSH private key file.

MySQL Hostname: 127.0.0.1 MySQL server host relative to the SSH server.

MySQL Server Port: 3306 TCP/IP port of the MySQL server.

Username: root Name of the user to connect with.

Password: Store in Vault ... Clear The MySQL user's password. Will be requested later if not set.

Default Schema: The schema to use as default schema. Leave blank to select it later.

Configure Server Management... Test Connection Cancel OK

Store Password For Connection

Please enter password for the following service:

Service: sch@192.168.203.128:22

User: paw

Password: *****

OK Cancel

Conexiune

The image shows a sequence of steps in MySQL Workbench:

- Configuration:** SSH Hostname: 192.168.203.128:22, SSH Username: paw, SSH Password: Store in Vault ..., MySQL Hostname: 127.0.0.1, MySQL Server Port: 3306, Username: root, Password: Store in Vault ...
- Setup New Connection:** Connection Name: Debian Paw, Connection Method: Standard TCP/IP over SSH.
- Test Connection:** A dialog box prompts for a password for the service. User: root, Password: [redacted].
- Warning:** A "Connection Warning" dialog box states: "Incompatible/nonstandard server version or connection protocol detected (10.11.6). A connection to this database can be established but some MySQL Workbench features may not work properly since the database is not fully compatible with the supported versions of MySQL. MySQL Workbench is developed and tested for MySQL Server versions 5.6, 5.7 and 8.0."
- Success:** A final dialog box states: "Successfully made the MySQL connection. Information related to this connection: Host: 127.0.0.1, Port: 3306, User: root, SSL: not enabled. A successful MySQL connection was made with the parameters defined for this connection."

Red annotations highlight the "Store in Vault ..." button, the "Test Connection" button, the "Ok" button in the password dialog, the "Continue Anyway" button in the warning dialog, and the "Successfully made the MySQL connection" message.

Configurare

[Browse Documentation >](#)

[Read the Blog >](#)

[Discuss on the Forum >](#)

MySQL Connections

Ubuntu local

root
student@192.168.100.129:22

Debian local;

root
paw@192.168.100.50:22

Debian Paw

root
paw@192.168.203.128:22

welcom

MySQL Workbench i
create and brows
design and run SQL q

[Browse Documentatic](#)

MySQL Connections 

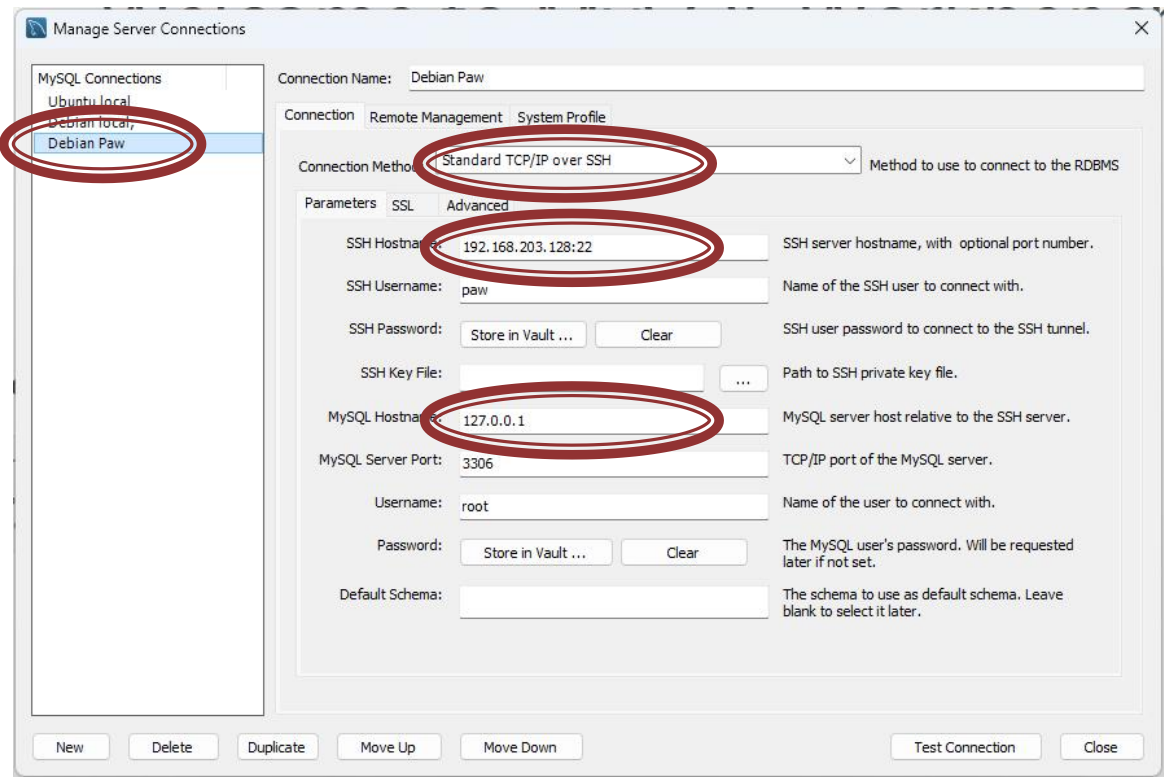

Manage Server Connections

MySQL Connections

- Ubuntu local
- Debian local;
- Debian Paw

Connection Name: Debian Paw

Connection: Remote Management System Profile

Connection Method: Standard TCP/IP over SSH Method to use to connect to the RDBMS

Parameters SSL Advanced

SSH Hostname: 192.168.203.128:22 SSH server hostname, with optional port number.

SSH Username: paw Name of the SSH user to connect with.

SSH Password: Store in Vault ... Clear SSH user password to connect to the SSH tunnel.

SSH Key File: ... Path to SSH private key file.

MySQL Hostname: 127.0.0.1 MySQL server host relative to the SSH server.

MySQL Server Port: 3306 TCP/IP port of the MySQL server.

Username: root Name of the user to connect with.

Password: Store in Vault ... Clear The MySQL user's password. Will be requested later if not set.

Default Schema: The schema to use as default schema. Leave blank to select it later.

New Delete Duplicate Move Up Move Down Test Connection Close

Configurare

The image displays two screenshots of the 'Manage Server Connections' dialog box in Red Hat Ansible Tower, illustrating the configuration process for a new connection.

Left Screenshot: Selection of Management Method

- Connection Name:** Debian Paw
- Connection Type:** Remote Management, System Profile
- Management Options:**
 - Do not use remote management
 - Native Windows remote management (only available on Windows)
 - SSH login based management
- Host Information:**
 - Hostname: 192.168.203.128
 - Port: (blank)
 - Username: paw
 - Password: (masked with 'Store in Vault ...')
 - SSH Key Path: (blank)
 - Authenticate Using SSH Key

Right Screenshot: Configuration Details

- Connection Name:** Debian Paw
- Connection Type:** Remote Management, System Profile
- Information:** Information about the server and MySQL configuration, such as path to the configuration file, command to start or stop it etc. You may pick a preset configuration profile or customize one for your needs.
- System Type:** Linux
- Installation Type:** Ubuntu Linux (sysvinit, Vendor Package)
- Configuration File:** /etc/mysql/my.cnf
- Configuration File Section:** mysqld
- MySQL Management:**
 - Start MySQL: /etc/init.d/mysql start
 - Stop MySQL: /etc/init.d/mysql stop
 - Force administrators to create start/stop commands and write configuration data
- Override sudo command line:** (blank)

Administrare/Control

The screenshot displays the MySQL Workbench Administration Dashboard. The interface includes a top menu bar (File, Edit, View, Query, Database, Server, Tools, Scripting, Help) and a sidebar with navigation options. The main dashboard area is divided into several sections:

- MANAGEMENT:** Server Status, Client Connections, Users and Privileges, Status and System Variables, Data Export, Data Import/Restore.
- INSTANCE:** Startup / Shutdown, Server Logs, Options File.
- Navigation:** Dashboard (circled in red), Performance Reports, Performance Schema Setup, Administration (circled in red), Schemas.
- Network Status:** Incoming Network Traffic (8.00 B/s receiving), Outgoing Network Traffic (5.27 KB/s sending), Client Connections (Total: 4, limit 151).
- MySQL Status:** Table Open Cache (63% Efficiency), SQL Statements Executed (#) (SELECT 0/s, INSERT 0/s, UPDATE 0/s, DELETE 0/s, CREATE 0/s, ALTER 0/s, DROP 0/s).
- InnoDB Status:** InnoDB Buffer Pool (4% Usage, 0 pages/s read reqs, 0 pages/s write reqs, 0 #/s disk reads), Redo Log (0 B/s data written, 0 #/s writes), InnoDB Disk Writes (0.00 B/s writing), InnoDB Disk Reads (0.00 B/s reading), Doublewrite Buffer (0/s writes).

Administrare/Control

The screenshot displays the MySQL Workbench Administration - Server Status page for a server named 'Debian Paw'. The left sidebar contains navigation options: MANAGE (Server Status, Client Connections, Users and Privileges, Status and System Variables, Data Export, Data Import/Restore), INSTANCE (Startup / Shutdown, Server Logs, Options File), PERFORMANCE (Dashboard, Performance Reports, Performance Schema Setup), and Administration (highlighted with a red circle). The main content area shows the following information:

Connection Name: Debian Paw

Host: pawetti

Socket: /run/mysqld/mysqld.sock

Port: 3306

Version: 10.11.6-MariaDB-0+deb12u1 (Debian 12)

Compiled For: debian-linux-gnu (x86_64)

Configuration File: /etc/mysql/my.cnf

Running Since: Mon Apr 15 14:21:29 2024 (0:55)

Available Server Features:

Performance Schema:	<input type="radio"/> Off	PAM Authentication:	<input type="radio"/> Off
Thread Pool:	<input type="radio"/> n/a	Password Validation:	<input type="radio"/> n/a
Memcached Plugin:	<input type="radio"/> n/a	Audit Log:	<input type="radio"/> n/a
Semisync Replication Plugin:	<input type="radio"/> Off	Firewall:	<input type="radio"/> n/a
SSL Availability:	<input checked="" type="radio"/> On	Firewall Trace:	<input type="radio"/> n/a

Server Directories:

Base Directory:	/usr
Data Directory:	/var/lib/mysql/
Disk Space in Data Dir:	16G of 19G available
Plugins Directory:	/usr/lib/mysql/plugin/
Tmp Directory:	/tmp
Error Log:	<input type="radio"/> Off
General Log:	<input type="radio"/> Off
Slow Query Log:	<input type="radio"/> Off

Server Status: Running

CPU/Load: 0.0

Connections: 4

Traffic: 19.10 KB/s

Key Efficiency: 0.0%

Selects per Second: 0

InnoDB Buffer Usage: 4.8%

InnoDB Reads per Second: 0

InnoDB Writes per Second: 0

Warning: this server is not a replica in a replication setup

SHA256 Password Private Key: n/a

SHA256 Password Public Key: n/a

SSL CA: n/a

SSL CA Path: n/a

SSL Cert: n/a

Realizarea bazei de date

- se creaza o noua baza de date:
 - in lista "Schemas" – Right click – Create New Schema
- se activeaza ca baza de date curenta noua "schema" – Dublu click pe numele ales

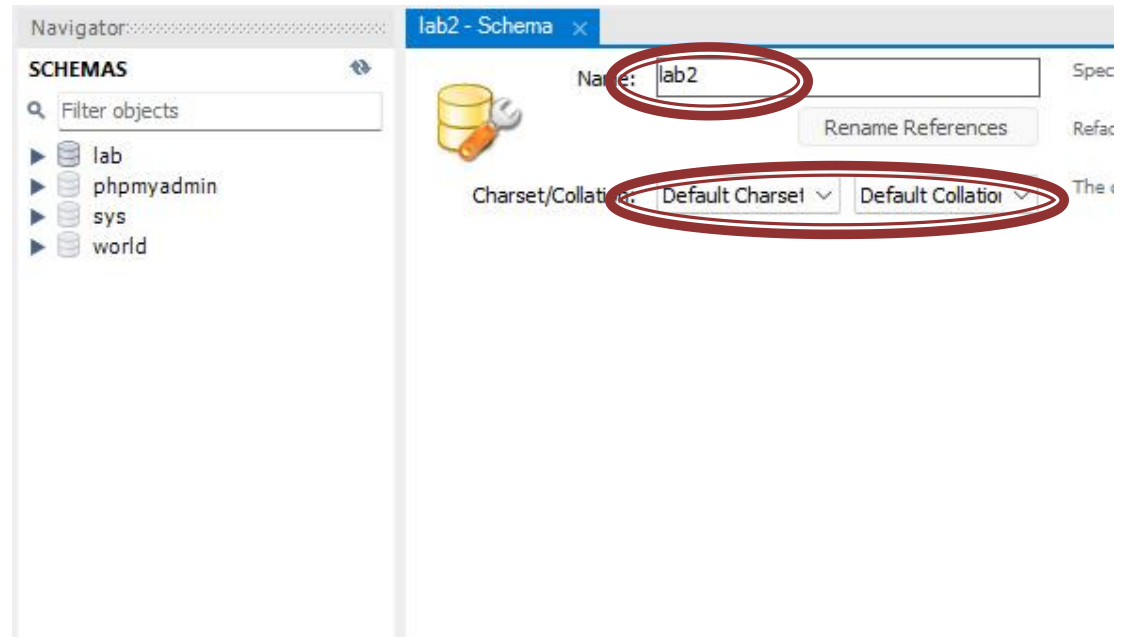
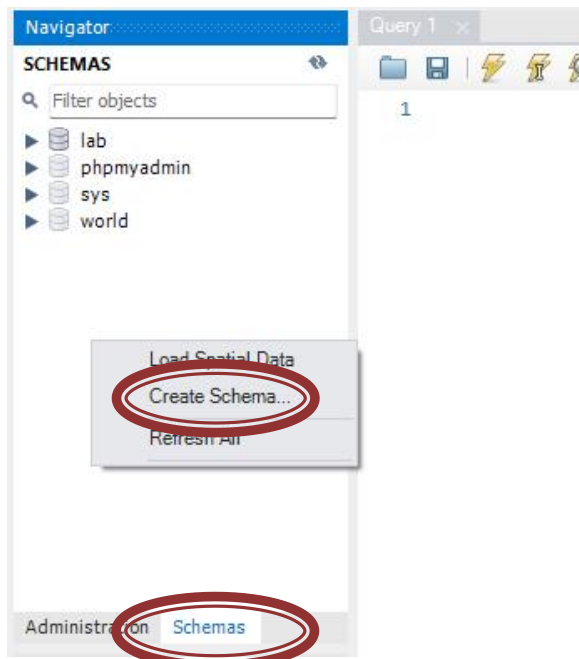

Realizarea bazei de date

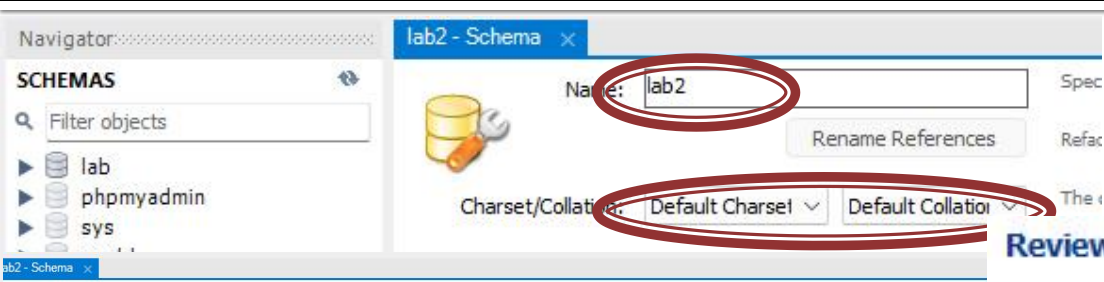

Review the SQL Script to be Applied on the Database

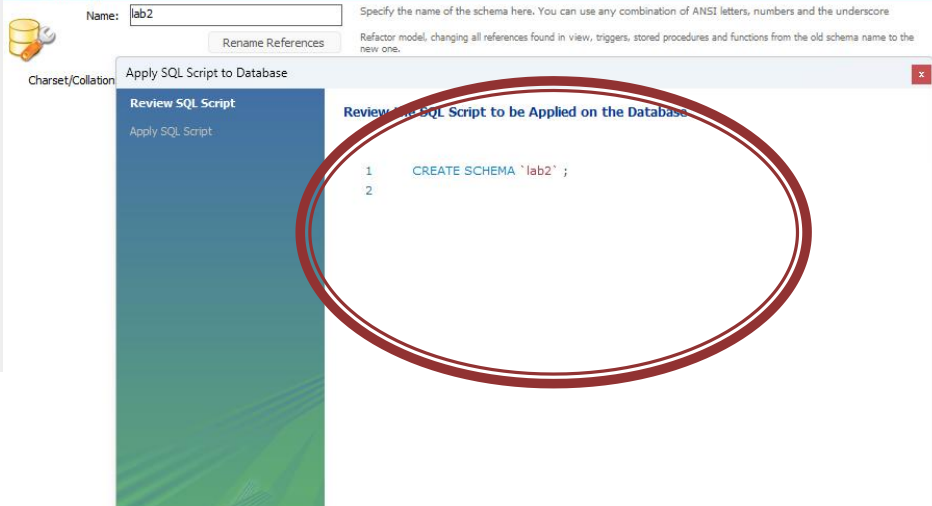

- 1
- 2

```
CREATE SCHEMA `lab2` ;
```

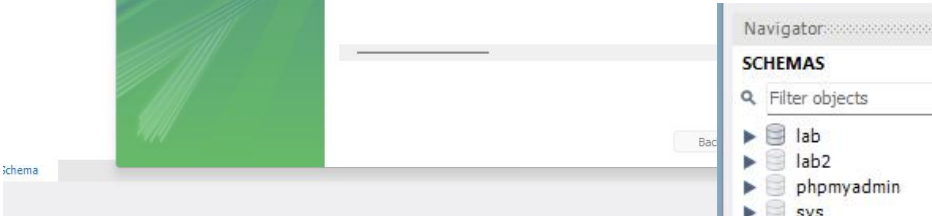
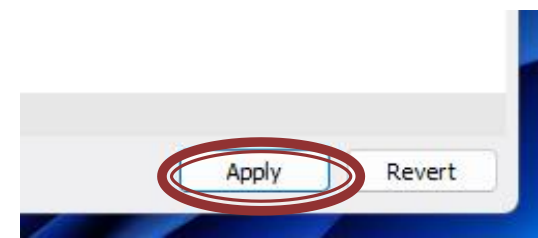

Introducere tabele

- Introducere tabel – Click sageata langa numele bazei de date – Tables – Right Click – Create Table
- se defineste structura tabelului
 - nume coloane
 - tip de date
 - NOT NULL – daca se accepta ca acea coloana sa ramana fara date (NULL) sau nu
 - AUTOINC – daca acea coloana va fi de tip intreg si va fi incrementata automat de server (util pentru crearea cheilor primare)
 - Default value – valoarea implicita care va fi inserata daca la introducerea unei linii noi nu se mentioneaza valoare pentru acea coloana (legat de optiunea NOT NULL)

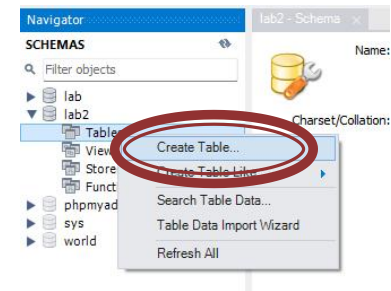

Tabel Categorii

Navigator: categorii - Table x

SCHEMAS

Filter objects

- lab
- lab2
 - Tables
 - Views
 - Stored Procedures
 - Functions
- phpmyadmin
- sys
- world

Table Name: categorii Schema: lab2

Charset/Collation: Default Charset Default Collation Engine: InnoDB

Comments:

Column Name	Datatype	PK	NN	UQ	B	UN	ZF	AI	G	Default/Expression
id_categ	INT	<input checked="" type="checkbox"/>	<input checked="" type="checkbox"/>	<input type="checkbox"/>	<input type="checkbox"/>	<input type="checkbox"/>	<input type="checkbox"/>	<input checked="" type="checkbox"/>	<input type="checkbox"/>	
nume	VARCHAR(45)	<input type="checkbox"/>	<input checked="" type="checkbox"/>	<input type="checkbox"/>	<input type="checkbox"/>	<input type="checkbox"/>	<input type="checkbox"/>	<input type="checkbox"/>	<input type="checkbox"/>	
detalii	VARCHAR(150)	<input type="checkbox"/>	<input type="checkbox"/>	<input type="checkbox"/>	<input type="checkbox"/>	<input type="checkbox"/>	<input type="checkbox"/>	<input type="checkbox"/>	<input type="checkbox"/>	

Apply SQL Script to Database

Review SQL Script

Apply SQL Script

Review the SQL Script to be Applied on the Database

```
1 CREATE TABLE `lab2`.`categorii` (  
2   `id_categ` INT NOT NULL AUTO_INCREMENT,  
3   `nume` VARCHAR(45) NOT NULL,  
4   `detalii` VARCHAR(150) NULL,  
5   PRIMARY KEY (`id_categ`));  
6
```

Tabel Prognose

produse - Table

Table Name: Schema: **lat**

Charset/Collation: Engine:

Comments:

Column Name	Datatype	PK	NN	UQ	B	UN	ZF	AI	G	Default/E:
id_produ	INT(11)	<input checked="" type="checkbox"/>	<input checked="" type="checkbox"/>	<input type="checkbox"/>	<input type="checkbox"/>	<input type="checkbox"/>	<input type="checkbox"/>	<input checked="" type="checkbox"/>	<input type="checkbox"/>	
id_categ	INT(11)	<input type="checkbox"/>	<input checked="" type="checkbox"/>	<input type="checkbox"/>	<input type="checkbox"/>	<input type="checkbox"/>	<input type="checkbox"/>	<input type="checkbox"/>	<input type="checkbox"/>	
nume	VARCHAR(45)	<input type="checkbox"/>	<input checked="" type="checkbox"/>	<input type="checkbox"/>	<input type="checkbox"/>	<input type="checkbox"/>	<input type="checkbox"/>	<input type="checkbox"/>	<input type="checkbox"/>	"
detalii	VARCHAR(150)	<input type="checkbox"/>	<input type="checkbox"/>	<input type="checkbox"/>	<input type="checkbox"/>	<input type="checkbox"/>	<input type="checkbox"/>	<input type="checkbox"/>	<input type="checkbox"/>	NULL
cant	INT(11)	<input type="checkbox"/>	<input type="checkbox"/>	<input type="checkbox"/>	<input type="checkbox"/>	<input type="checkbox"/>	<input type="checkbox"/>	<input type="checkbox"/>	<input type="checkbox"/>	NULL
cost	FLOAT	<input type="checkbox"/>	<input type="checkbox"/>	<input type="checkbox"/>	<input type="checkbox"/>	<input type="checkbox"/>	<input type="checkbox"/>	<input type="checkbox"/>	<input type="checkbox"/>	NULL

Column Name: Data T

Charset/Collation: Del

Comments: Stor

Columns Indexes Foreign Keys Triggers Partitioning Options

Introducere date initiale

The screenshot illustrates the process of inserting initial data into a database table. The interface shows a Navigator pane on the left with the following structure:

- SCHEMAS
- lab
- lab2
 - Tables
 - categoriaii
 - produse
 - Views
 - Stored Procedures
 - Functions
- phpmyadmin
- sys
- world

The SQL editor at the top displays the following query:

```
1 • SELECT * FROM lab2.categoriaii;
```

The Result Grid below shows the initial state of the data, with all cells containing NULL:

id_categ	nume	detalii
NULL	NULL	NULL

The bottom part of the screenshot shows the same SQL query, but the Result Grid now contains the following data rows:

id_categ	nume	detalii
NULL	papetarie	NULL
NULL	instrumente	NULL
NULL	audio-video	NULL
NULL	NULL	NULL

Red circles and arrows highlight the SQL query and the resulting data rows, indicating the flow of data from the query to the table.

Introducere date initiale

- Completare in rezultat + Buton Apply



Introducere date prin script

The screenshot displays the SQL Enterprise Manager interface. The main window shows a script with the following SQL commands:

```
1 CREATE TABLE `lab2`.`produse` (  
2  
3 INSERT INTO `lab2`.`produse` (`id_produs`,`id_categ`,`nume`,`detalii`,`cant`  
4  
5 (1,1,'carte','mai multe pagini scrise legate',0,100),  
6  
7 (2,1,'caiet','mai multe pagini goale legate',0,75),  
8  
9 (3,1,'hartie scris','mai multe pagini goale NElegate',0,50),  
10  
11 (4,2,'penar','loc de depozitat instrumente de scris',0,150),  
12  
13 (5,2,'stilou','instrument de scris albastru',0,125),  
14  
15 (6,2,'creion','instrument de scris scris',0,25),  
16  
17 (7,3,'cd','canta',0,50),  
18  
19 (8,3,'dvd','vizual',0,100),  
20  
21 (9,3,'blue ray','vizual extrem',0,500);
```

The 'Output' window at the bottom shows the execution results:

#	Time	Action	Message	
5	15:32:51	Apply changes to categorii	Changes applied	
6	15:35:34	Apply changes to categorii	No changes detected	
7	15:35:34	Apply changes to categorii	No changes detected	
9	15:37:58	CREATE TABLE `lab2`.`produse` (`id_produs` INT NOT NULL AUTO_IN...	0 row(s) affected	0.015 sec
10	15:37:58	INSERT INTO `lab2`.`produse` (`id_produs`,`id_categ`,`nume`,`detalii`,`ca...	9 row(s) affected Records: 9 Duplicates: 0 Warnings: 0	0.009 sec
10	15:38:24	SELECT * FROM `lab2`.`produse` LIMIT 0, 50000	9 row(s) returned	0.000 sec / 0.000 sec

Red circles and arrows highlight the 'SQL' icon in the toolbar, the 'Execute' button (lightning bolt), the 'Refresh All' button in the context menu, and the 'Output' window.

Index in tabelul produse

The image shows a database management interface with the following components:

- Navigator:** Shows a tree view of schemas including 'lab', 'lab2', 'produse', 'categorii', 'Views', 'Stored Procedures', 'Functions', 'phpmyadmin', 'sys', and 'world'. A red circle highlights the 'produse' table icon.
- Table Properties (Top):** Shows 'Table Name: produse', 'Schema: lab', 'Charset/Collation: utf8mb4', and 'Engine: InnoDB'.
- Table Structure:** A table listing columns: id_produc (INT(11), PK, NN), id_categ (INT(11), NN), nume (VARCHAR(45)), detalii (VARCHAR(150)), cant (INT(11)), and pret (FLOAT).
- Indexes Tab (Middle):** Shows a table with columns 'Index Name' and 'Type'. A red circle highlights the row for 'id_categ' with type 'INDEX'.
- Index Columns (Bottom):** A table with columns 'Column', 'Order', and 'Length'. A red circle highlights the row for 'id_categ' with 'Order' 1.

Column Name	Datatype	PK	NN	UQ	B	UN	ZF	AI	G	Default/E
id_produc	INT(11)	<input checked="" type="checkbox"/>	<input checked="" type="checkbox"/>	<input type="checkbox"/>	<input type="checkbox"/>	<input type="checkbox"/>	<input type="checkbox"/>	<input checked="" type="checkbox"/>	<input type="checkbox"/>	
id_categ	INT(11)	<input type="checkbox"/>	<input checked="" type="checkbox"/>	<input type="checkbox"/>	<input type="checkbox"/>	<input type="checkbox"/>	<input type="checkbox"/>	<input type="checkbox"/>	<input type="checkbox"/>	
nume	VARCHAR(45)	<input type="checkbox"/>	<input checked="" type="checkbox"/>	<input type="checkbox"/>	<input type="checkbox"/>	<input type="checkbox"/>	<input type="checkbox"/>	<input type="checkbox"/>	<input type="checkbox"/>	"
detalii	VARCHAR(150)	<input type="checkbox"/>	<input type="checkbox"/>	<input type="checkbox"/>	<input type="checkbox"/>	<input type="checkbox"/>	<input type="checkbox"/>	<input type="checkbox"/>	<input type="checkbox"/>	NULL
cant	INT(11)	<input type="checkbox"/>	<input type="checkbox"/>	<input type="checkbox"/>	<input type="checkbox"/>	<input type="checkbox"/>	<input type="checkbox"/>	<input type="checkbox"/>	<input type="checkbox"/>	NULL
pret	FLOAT	<input type="checkbox"/>	<input type="checkbox"/>	<input type="checkbox"/>	<input type="checkbox"/>	<input type="checkbox"/>	<input type="checkbox"/>	<input type="checkbox"/>	<input type="checkbox"/>	NULL

Index Name	Type
PRIMARY	PRIMARY
id_categ	INDEX

Column	Order	Length
<input type="checkbox"/> id_produc	ASC	
<input checked="" type="checkbox"/> id_categ	1 ASC	
<input type="checkbox"/> nume	ASC	
<input type="checkbox"/> detalii	ASC	
<input type="checkbox"/> cant	ASC	
<input type="checkbox"/> pret	ASC	

User si drepturi de acces

■ Probleme de compatibilitate

The screenshot displays the MySQL Workbench 'Users and Privileges' configuration page. The left sidebar shows the navigation menu with 'Users and Privileges' and 'Administration' highlighted. The main area shows a table of user accounts and a detailed configuration for the 'newuser@%' account.

User	From Host
lab_user	%
mariadb.sys	localhost
mysql	localhost
phpmyadmin	localhost
root	localhost
web	%

Details for account newuser@%

Authentication Type: **unix_socket** (Weak password)

Weak password message: Weak password.

Buttons: Add Account, Delete, Refresh

Privilegii

Administration - Users and Privil...

Debian Paw
Users and Privileges

User Accounts

User	From Host
lab_user	%
mariadb.sys	localhost

Details for account newuser@%

Login Account Limits Administrative Roles Schema Privileges

Schema Privileges

New Schema Privilege Definition

Select the Schema for which the user 'newuser' will have the privileges you want to define.

Schema

All Schema (%) This rule will apply to any schema name.

Schemas matching pattern: This rule will apply to schemas that match the given name or pattern. You may use _ and % as wildcards in a pattern. Escape these characters with \ in case you want their literal value.

Selected schema: lab2 Select a specific schema name for the rule to apply to.

Add Entry...

Cancel OK

Details for account lab2_user@%

Login Account Limits Administrative Roles Schema Privileges

Schema Privileges

Schema	Privileges
lab2	DELETE, INSERT, SELECT, UPDATE

Schema and Host fields may use % and _ wildcards. The server will match specific entries before wildcarded ones.

The user 'lab2_user'@'%' will have the following access rights to the schema:

Subject Rights

- SELECT
- INSERT
- UPDATE
- DELETE
- EXECUTE
- SHOW VIEW

DDL Rights

- CREATE
- ALTER
- REFERENCES
- INDEX
- CREATE VIEW
- CREATE ROUTINE
- ALTER ROUTINE
- EVENT
- DROP

Backup

The screenshot shows the PostgreSQL Administration tool interface for a server named 'Debian Paw'. The 'Data Export' window is open, showing the configuration for exporting data from the 'lab2' schema. The left sidebar contains a 'MANAGEMENT' section with 'Data Export' highlighted, and an 'Administration' section with 'Administration' highlighted. The main area shows the 'Object Selection' tab with 'lab2' selected in the 'Tables to Export' list. The 'categorias' and 'produse' tables are selected in the 'Schema Objects' list. The 'Export Options' section shows 'Export to Self-Contained File' selected, with the file path 'E:\Documents\dumps\Dump20240422.sql'. The 'Include Create Schema' checkbox is also checked. The 'Start Export' button is located at the bottom right.

Administration - Data Export

Debian Paw
Data Export

Object Selection | Export Progress

Tables to Export

Exp...	Schema
<input type="checkbox"/>	lab
<input checked="" type="checkbox"/>	lab2
<input type="checkbox"/>	phoenix
<input type="checkbox"/>	sys
<input type="checkbox"/>	world

Refresh 2 tables selected

Exp...	Schema Objects
<input checked="" type="checkbox"/>	categorias
<input checked="" type="checkbox"/>	produse

Dump Structure and Dat Select Views Select Tables Unselect All

Objects to Export

Dump Stored Procedures and Functions Dump Events Dump Triggers

Export Options

Export to Dump Project Folder E:\Documents\dumps\Dump20240422

Export to Self-Contained File E:\Documents\dumps\Dump20240422.sql

All selected database objects will be exported into a single, self-contained file.

Create Dump in a Single Transaction (self-contained file only) Include Create Schema

Press [Start Export] to start...

Start Export

Restore – rulare script

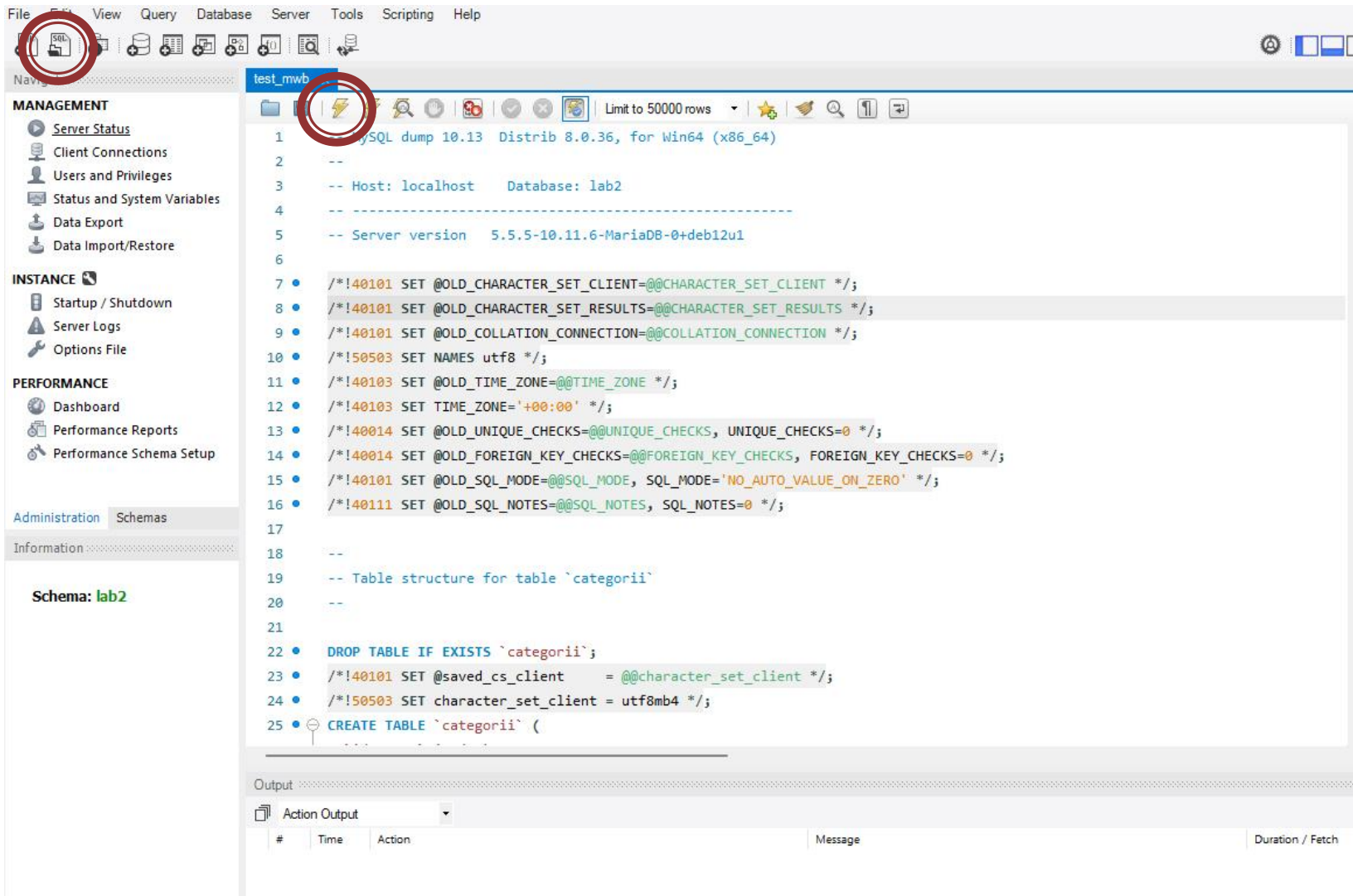

The screenshot shows the MySQL Workbench interface. The top menu bar includes File, Edit, View, Query, Database, Server, Tools, Scripting, and Help. The left sidebar contains a 'MANAGEMENT' section with options like Server Status, Client Connections, Users and Privileges, Status and System Variables, Data Export, and Data Import/Restore. Below that is an 'INSTANCE' section with Startup / Shutdown, Server Logs, and Options File. The 'PERFORMANCE' section includes Dashboard, Performance Reports, and Performance Schema Setup. The bottom left shows 'Administration' and 'Schemas' tabs, with 'Schemas' selected and 'Schema: lab2' displayed.

The main window shows a SQL script for restoring a database. The script is as follows:

```
1 MySQL dump 10.13 Distrib 8.0.36, for Win64 (x86_64)
2 --
3 -- Host: localhost Database: lab2
4 -----
5 -- Server version 5.5.5-10.11.6-MariaDB-0+deb12u1
6
7 /*!40101 SET @OLD_CHARACTER_SET_CLIENT=@@CHARACTER_SET_CLIENT */;
8 /*!40101 SET @OLD_CHARACTER_SET_RESULTS=@@CHARACTER_SET_RESULTS */;
9 /*!40101 SET @OLD_COLLATION_CONNECTION=@@COLLATION_CONNECTION */;
10 /*!50503 SET NAMES utf8 */;
11 /*!40103 SET @OLD_TIME_ZONE=@@TIME_ZONE */;
12 /*!40103 SET TIME_ZONE='+00:00' */;
13 /*!40014 SET @OLD_UNIQUE_CHECKS=@@UNIQUE_CHECKS, UNIQUE_CHECKS=0 */;
14 /*!40014 SET @OLD_FOREIGN_KEY_CHECKS=@@FOREIGN_KEY_CHECKS, FOREIGN_KEY_CHECKS=0 */;
15 /*!40101 SET @OLD_SQL_MODE=@@SQL_MODE, SQL_MODE='NO_AUTO_VALUE_ON_ZERO' */;
16 /*!40111 SET @OLD_SQL_NOTES=@@SQL_NOTES, SQL_NOTES=0 */;
17
18 --
19 -- Table structure for table `categorii`
20 --
21
22 DROP TABLE IF EXISTS `categorii`;
23 /*!40101 SET @saved_cs_client = @@character_set_client */;
24 /*!50503 SET character_set_client = utf8mb4 */;
25 CREATE TABLE `categorii` (
```

The 'Output' section at the bottom shows a table with columns for #, Time, Action, Message, and Duration / Fetch. The 'Action Output' dropdown is currently set to 'Action Output'.

Restore - interfata

test_mwb Administration - Data Import/Res...

Debian Paw
Data Import

Import from Disk Import Progress

Import Options

Import from Dump Project Folder E:\Documents\dumps

Select the Dump Project Folder to import. You can do a selective restore.

Load Folder Contents

Import from Self-Contained File E:\Documents\Curs PAW\2024\c8\test_mwb.sql

Select the SQL/dump file to import. Please note that the whole file will be imported.

Default Schema to be Imported To

Default Target Schema: lab2

Select Database Objects to Import (only available for Project Folders)

Imp...	Schema
--------	--------

Table: **categoriai**

Columns:

Column Name	Column Type
id_categ	int(11) AI PK
nume	varchar(45)
detalii	varchar(150)

Administration Schemas

Navigation: Administration - Data Import/Res...

Debian Paw
Data Import

Press [Start Import] to start...

Status:

Log:

Administration Schemas

Script SQL Backup - utilitate

- Poate fi folosit ca un model extrem de bun pentru comenzile necesare pentru crearea programatica (din PHP de exemplu) a bazei de date

```
CREATE DATABASE IF NOT EXISTS tmpaw;
USE tmpaw;

DROP TABLE IF EXISTS `categorii`;
CREATE TABLE `categorii` (
  `id_categ` int(10) unsigned NOT NULL auto_increment,
  `nume` varchar(45) NOT NULL,
  `detalii` varchar(150) default NULL,
  PRIMARY KEY (`id_categ`)
) ENGINE=InnoDB DEFAULT CHARSET=latin1;

INSERT INTO `categorii` (`id_categ`,`nume`,`detalii`) VALUES
(1,'papetarie',NULL),
(2,'instrumente',NULL),
(3,'audio-video',NULL);
```

Contact

- Laboratorul de microunde si optoelectronica
- <https://rf-opto.etti.tuiasi.ro>
- rdamian@etti.tuiasi.ro