

Optoelectronică, structuri și tehnologii

Curs 9
2012/2013

Orar

▶ Curs

- marti, 13-16, P7
- $2C \Rightarrow 3C$
 - $(14-4)*2/3 \approx 6.66$
 - $4+6.66=11-0.33$

Dioda Laser

Capitolul 9

Partea II

Recapitulare

Caracteristici dioda laser

▶ Avantaje

- Putere optica ridicata (50mW functionare continua, 4W functionare in impulsuri)
- Precizie ridicata a controlului (impulsuri cu latimea de ordinul fs – femptosecunde) – viteza mare de lucru
- Spectru ingust, teoretic LASER ofera o singura linie spectrala
- Lumina coerenta si directiva (~80% poate fi cuplata in fibra)

▶ Dezavantaje

- Cost (dispozitiv si circuit de comanda: controlul puterii si al temperaturii)
- Durata de viata
- Sensitivitate crescuta cu temperatura
- Modulatie analogica dificila (de obicei cu dispozitive externe)
- Lungime de unda fixa

Dependența benzii interzise de constanta rețelei

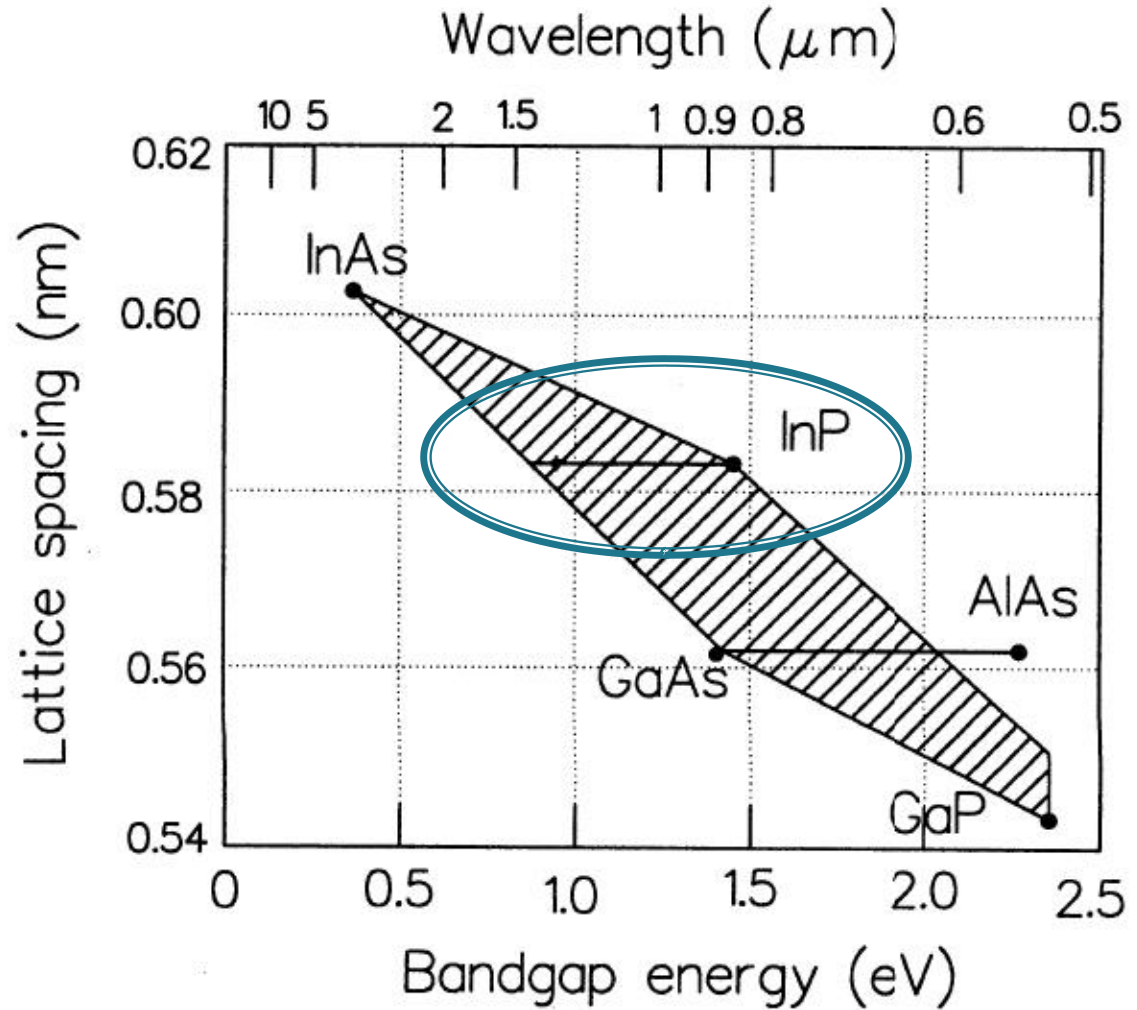
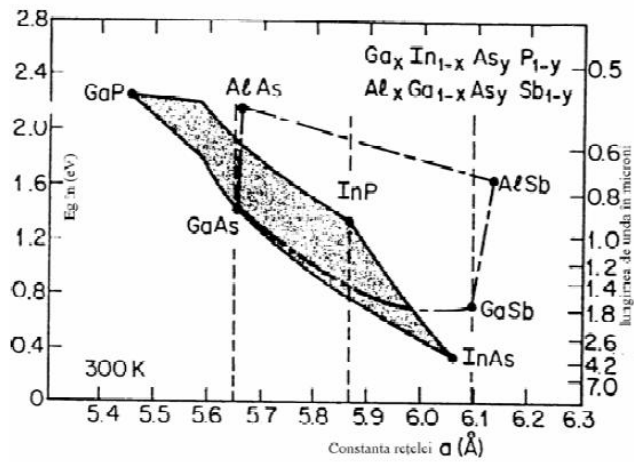

Materialie cu 4 nivele energetice

- ▶ La un material cu 4 nivele energetice tranzitia radianta a electronului (3) se termina intr-o stare instabila, starea de echilibru obtinandu-se prin emisia unui fonon
- ▶ Inversiunea de populatie se obtine mult mai usor datorita electronilor din starea intermediara

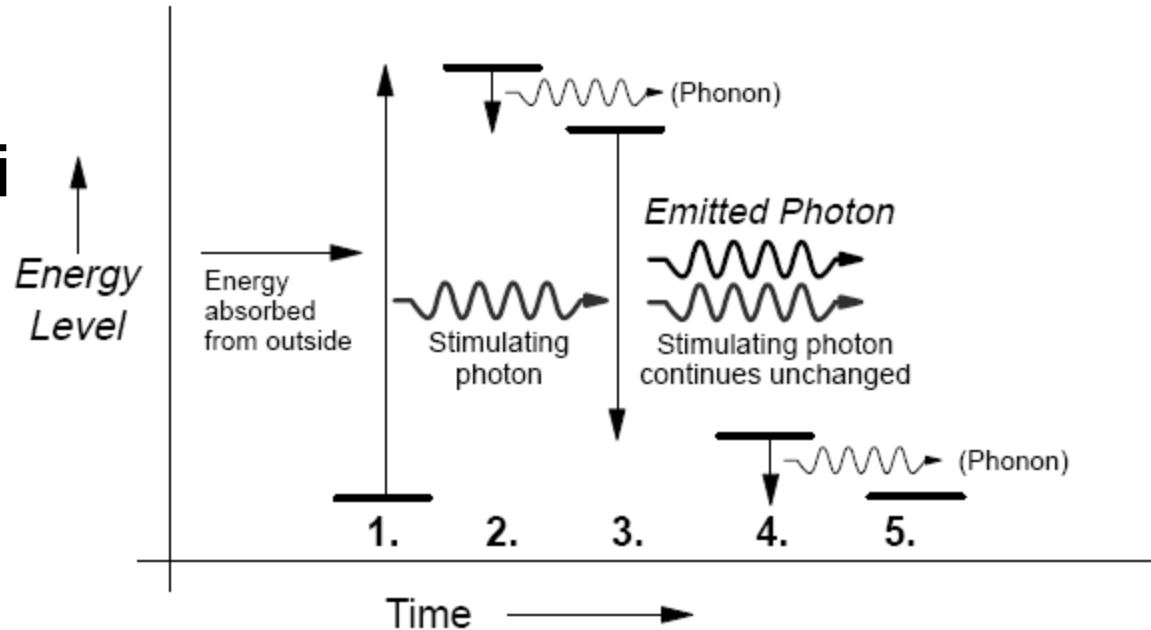

Dioda LASER Fabry Perot

- ▶ Pentru diodele laser utilizate in comunicatii reflectivitatea oglinzilor nu trebuie sa fie foarte mare
- ▶ Interfata semiconductor aer ofera un coeficient de reflexie de $\sim 6\%$ dar poate ajunge la 36% pentru lungimea de unda de operare (vezi lamela dielectrica)

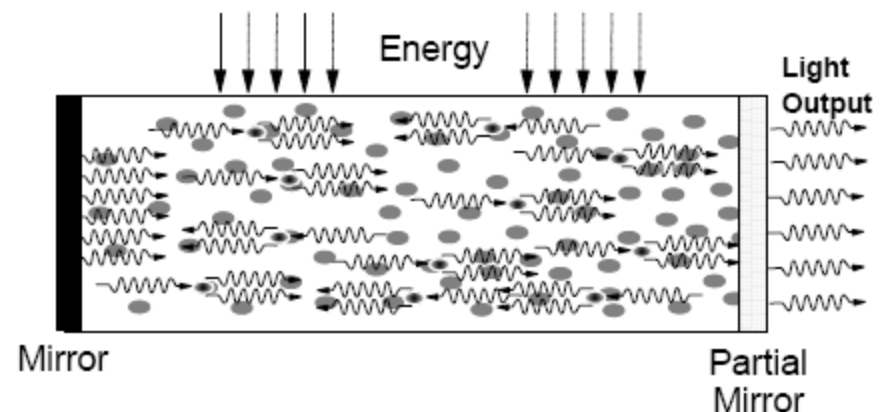
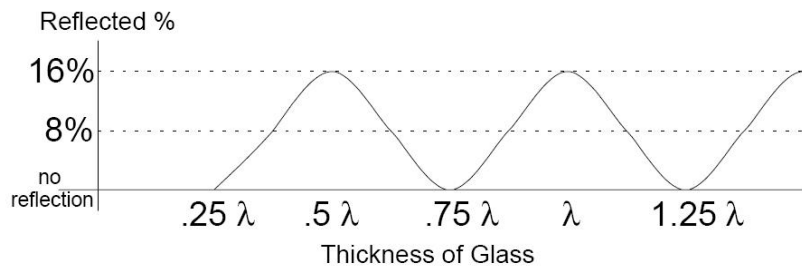

Distributed Feedback (DFB) Lasers

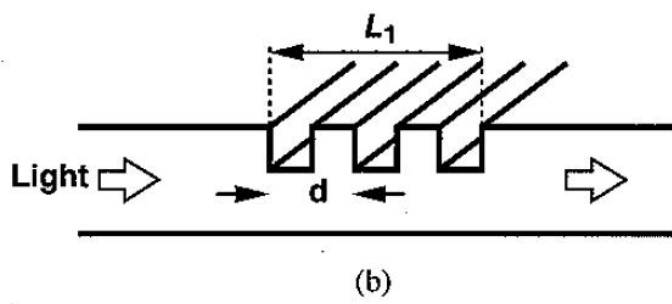
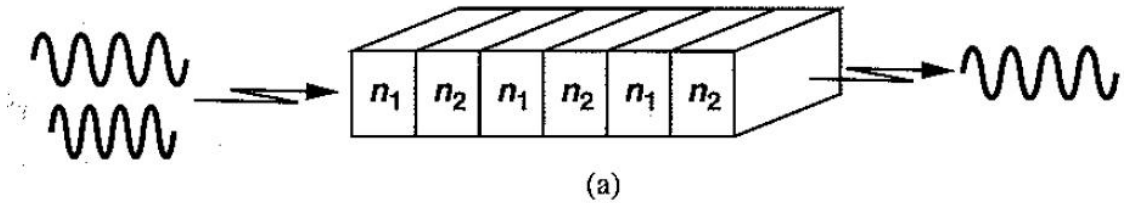
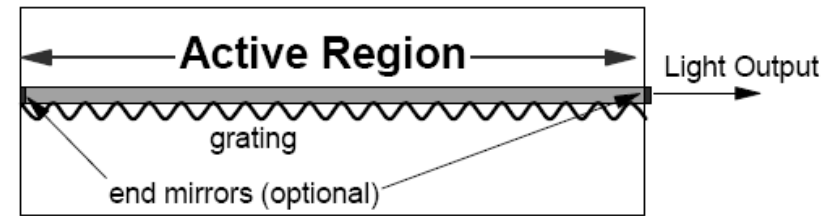
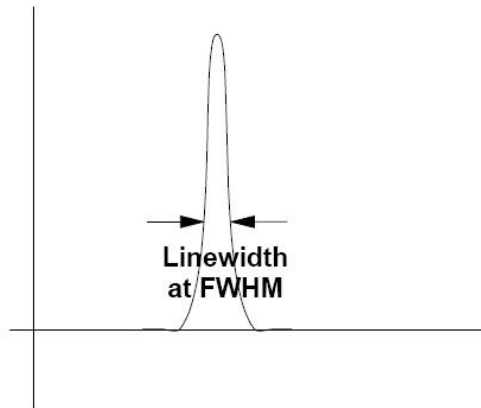
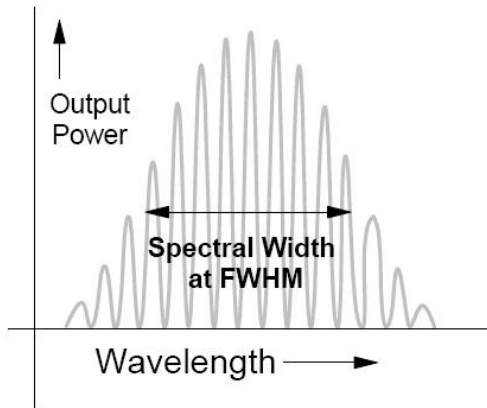

Diode laser reglabile

- ▶ Dezavantajul metodelor anterioare e dat de limita redusa a reglajului (~10nm)
- ▶ Reflectorul Bragg esantionat (periodic) produce spectru de filtrare discret

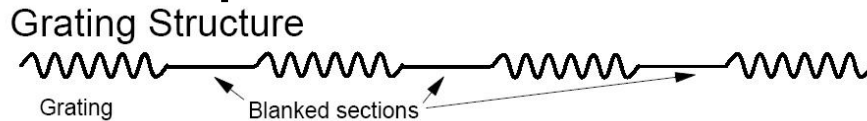

Dezavantaj :
reglajul e discret

- ▶ Regland unul din reflectori se obtine rezonanta la suprapunerea celor doua spectre

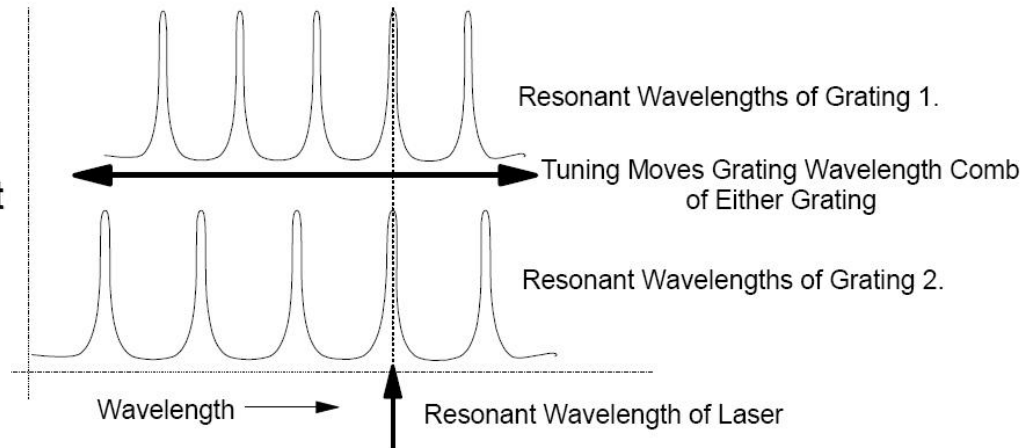
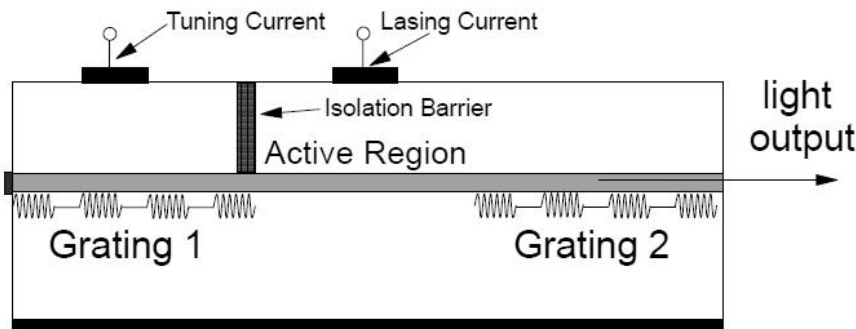

Continuare



Vertical Cavity Surface Emitting Lasers (VCSEL)

- ▶ Oglinzile pot fi realizate din straturi succesive din semiconductori cu indici de refractie diferiti – reflector Bragg
- ▶ Prelucrarea laterala se rezuma la taierea materialului
 - ▶ Caracteristici
 - ▶ puteri de ordinul 1mW
 - ▶ lungimi de unda 850 si 980 nm
 - ▶ radiatie de iesire circulara cu divergenta redusa
 - ▶ Curenti de prag foarte mici (5mA) si putere disipata redusa
 - ▶ circuite de control speciale nu sunt necesare
 - ▶ Banda de modulatie mare (2.4GHz)
 - ▶ Stabilitate mare cu temperatura si durata de viata

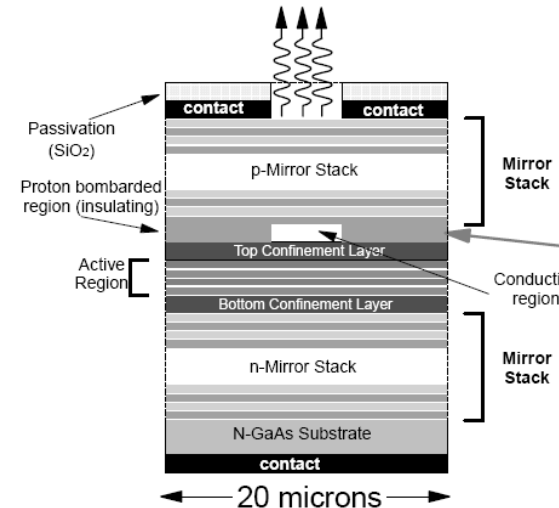

VCSEL

▶ Caracteristici

- VCSEL produce mai multe moduri transversale
 - insensibila la pierderile selective la mod din fibrele multimod (principala limitare in utilizarea diodelor laser in fibrele multimod)

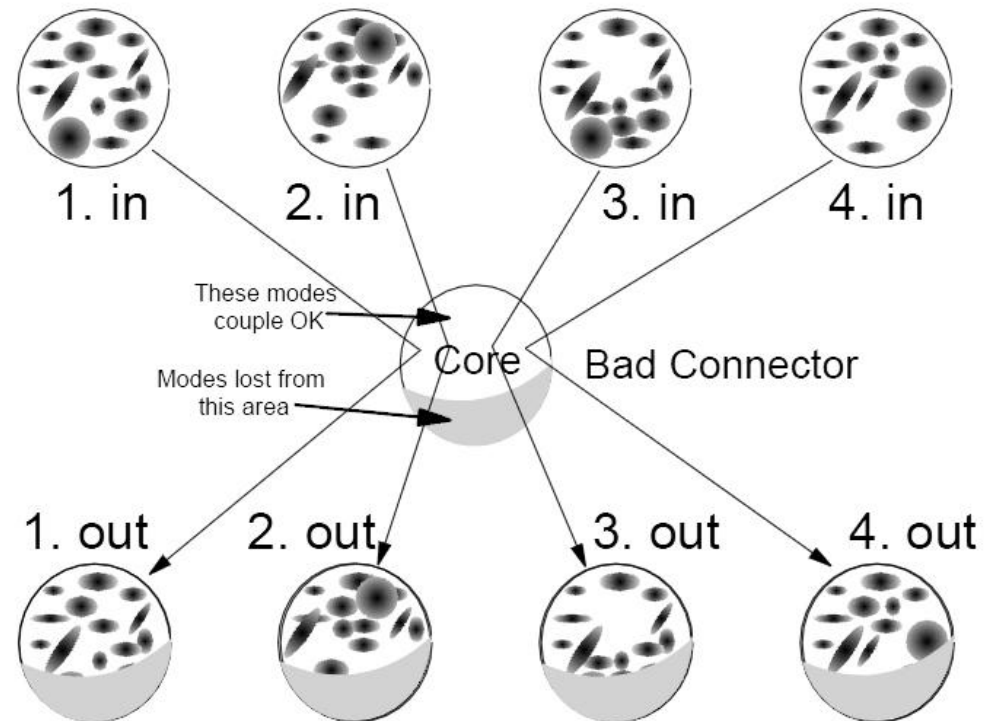

Dependenta de temperatura

- ▶ Dependenta de temperatura a curentului de prag este exponentiala

- ▶
$$I_{th} = I_0 \cdot e^{T/T_0}$$

- ▶ I_0 e o constanta determinata la temperatura de referinta

Material	Lungime de unda	T_0
InGaAsP	1300 nm	60÷70 K
InGaAsP	1500 nm	50÷70 K
GaAlAs	850 nm	110÷140 K

Degradare in timp

- ▶ Puterea scade in timp exponential

$$P(t) = P_0 \cdot e^{-t/\tau_m}$$

- ▶ τ_m – timpul de viata
- ▶ Diodele laser sunt supuse la conditii extreme de lucru
 - densitati de curent in zona activa $2000 \div 5000 \text{ A/cm}^2$
 - densitati de putere optica: $10^5 \div 10^6 \text{ W/cm}^2$
- ▶ Diverse definitii ale timpului de viata fac comparatiile dificile

Degradare in timp

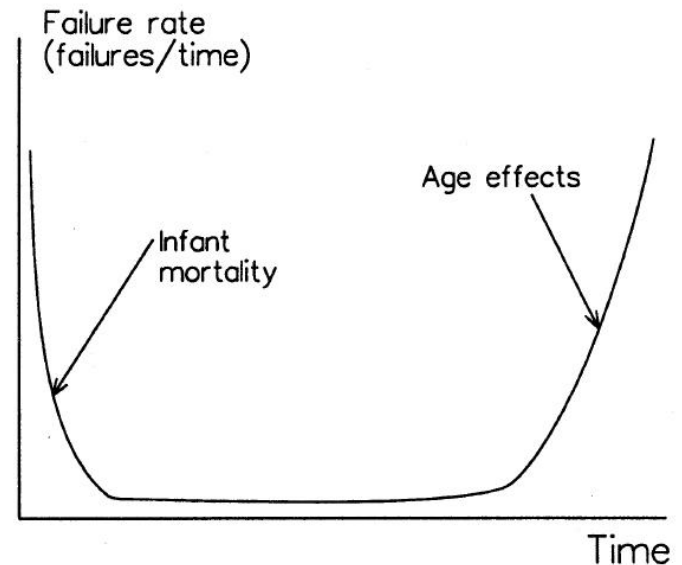

- ▶ Cresterea curentului duce la scaderea duratei de viata

$$\tau_m \sim J^{-n}$$

- $n = 1.5 \div 2$ (empiric)
- dublarea curentului duce la scaderea de 3-4 ori a duratei de viata
- ▶ Cresterea temperaturii duce la scaderea duratei de viata

$$\tau_m \sim e^{E/kT}$$

- $E = 0.3 \div 0.95 \text{ eV}$ (valoarea tipica in teste 0.7 eV)
- cresterea temperaturii cu 10 grade injumatateste durata de viata

Caracteristici curent tensiune

- ▶ Amorsarea emisiei stimulate necesita pomparea unei anumite cantitati de energie - curent de prag

$I < I_{th}$ regim LED

ineficient!

$I > I_{th}$ regim LASER

$$r = \frac{\Delta P_o}{\Delta I} \left[\frac{W}{A} \right]$$

Apare saturare la nivele mari de curent

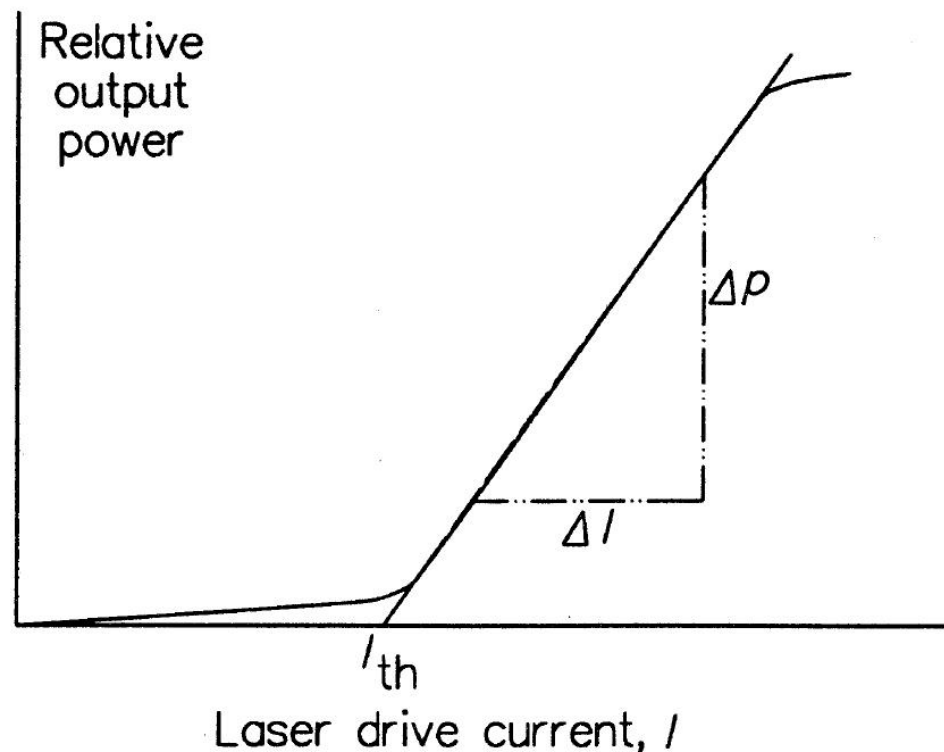

Eficienta

- ▶ eficienta de conversie electro-optic (randament)

$$\eta = \frac{P_{out}(optic)}{P_{in}(electric)} = \frac{P_o}{V_f \cdot I_f} \approx \frac{r \cdot (I_f - I_{th})}{V_f \cdot I_f}$$

- ▶ tipic, randamente sub 10% sunt intalnite
- ▶ eficienta cuantica

$$\eta = \frac{n_f}{n_e} \quad \eta = \frac{\Delta P / h\nu}{\Delta I / e} = r \cdot \frac{e}{h\nu}$$

1550nm DFB Laser

Mechanical Drawing

All units in mm

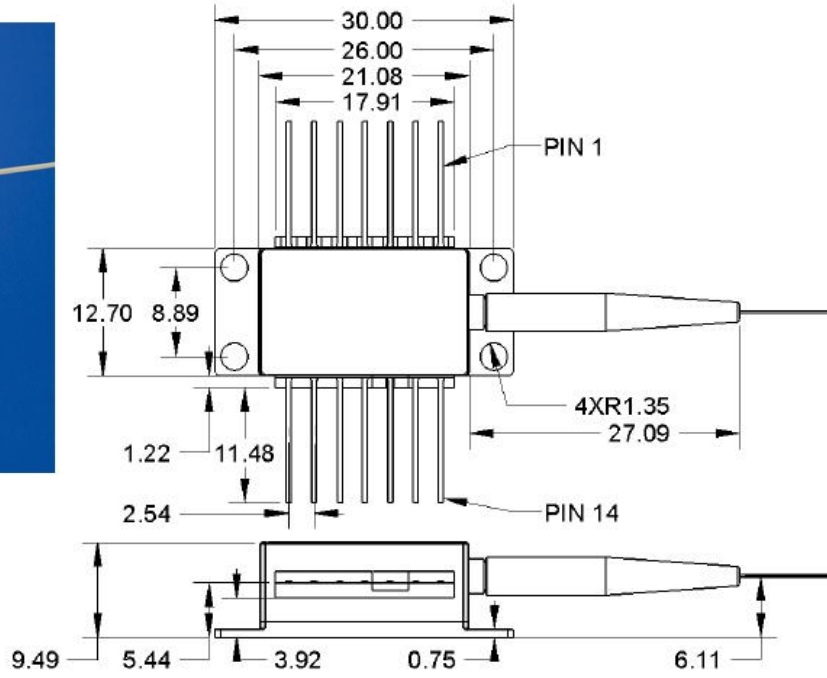

Pin out

Pin	Description
1	Thermistor
2	Thermistor
3	Laser Cathode (Bias)
4	Monitor PD Anode
5	Monitor PD Cathode
6	TEC +
7	TEC -
8	Case GND, Laser Anode
9	Case GND, Laser Anode
10	Case GND, Laser Anode
11	Case GND, Laser Anode
12	Laser Cathode (modulation)
13	Case GND, Laser Anode
14	Case GND, Laser Anode

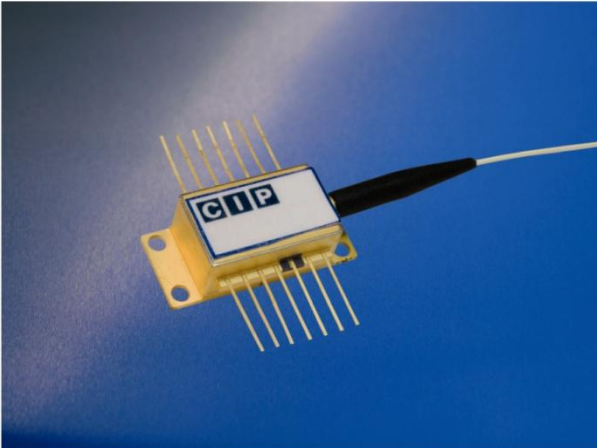

1550nm DFB Laser

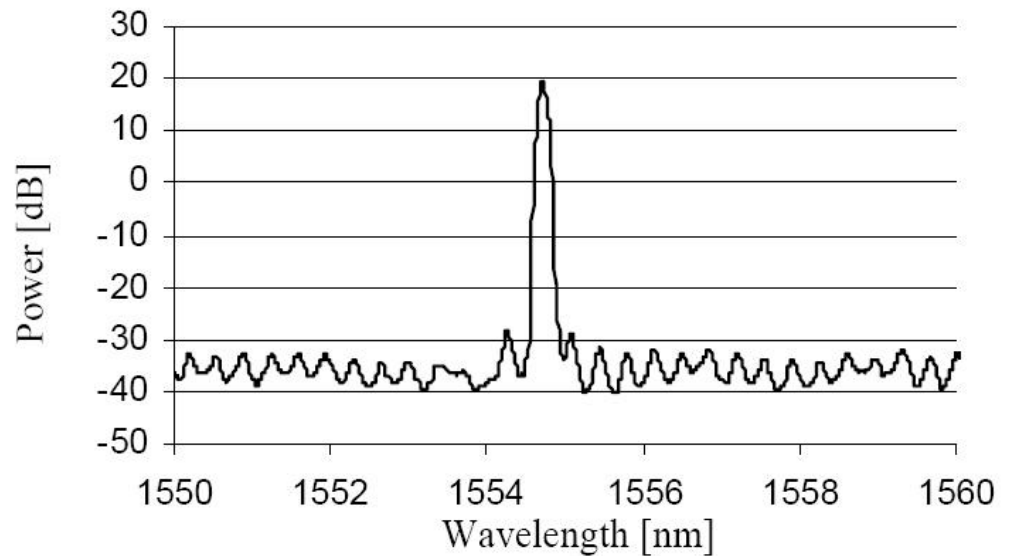
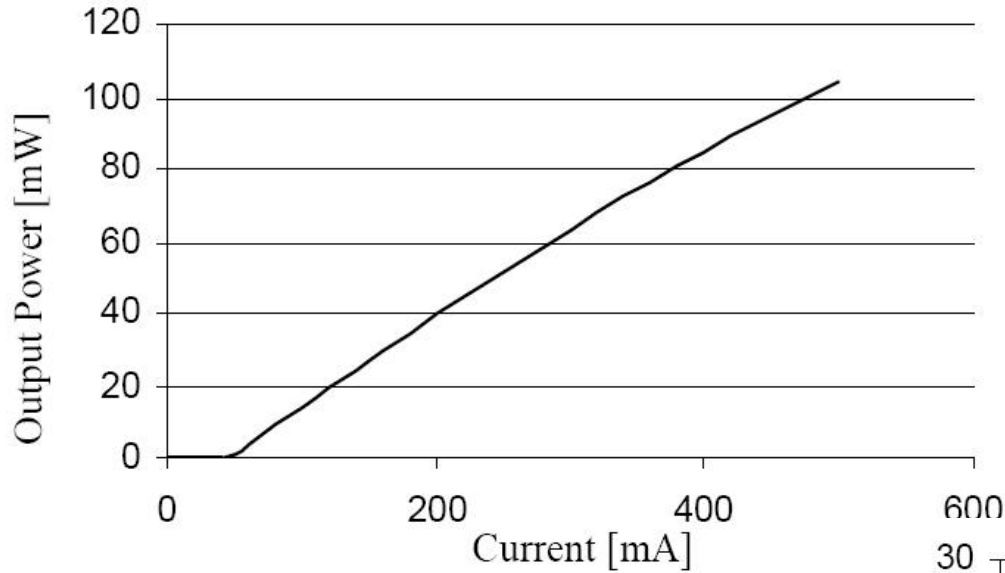

1550nm MQW Laser

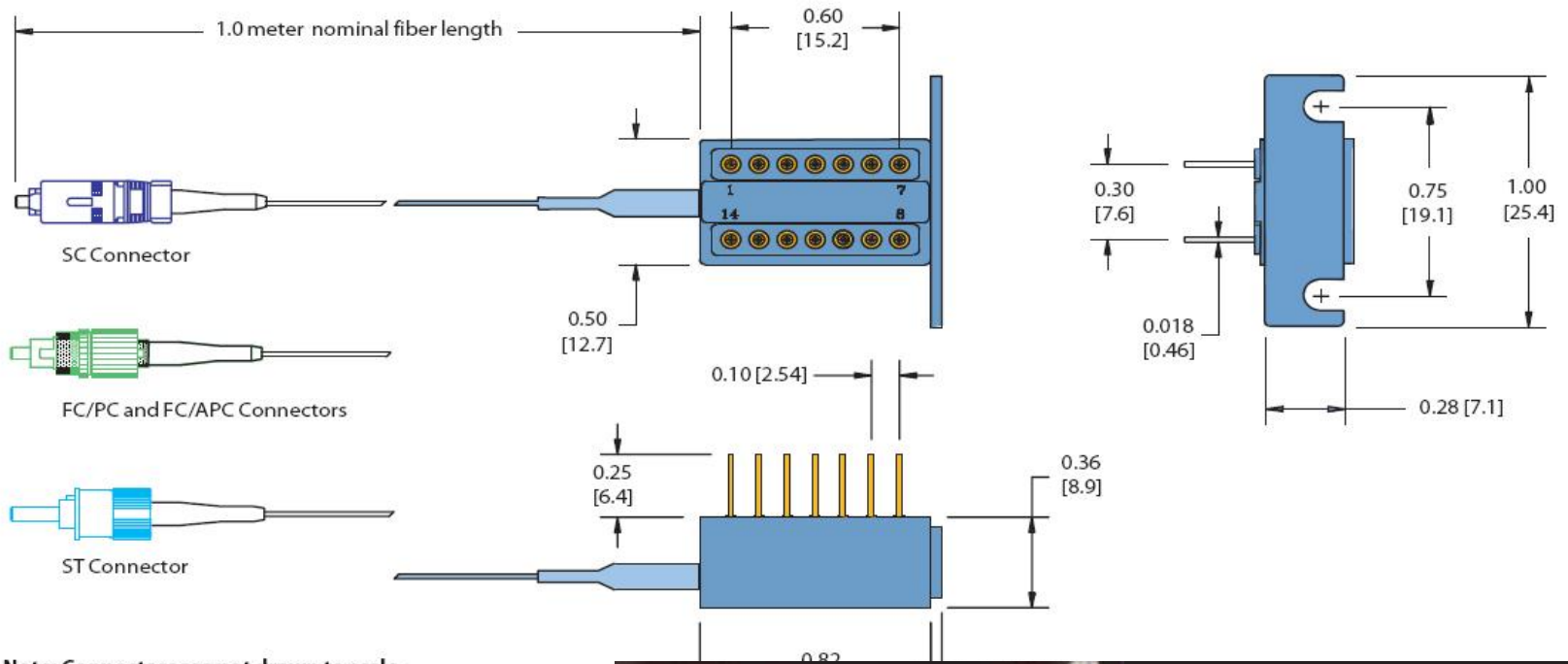

Note: Connectors are not drawn to scale.

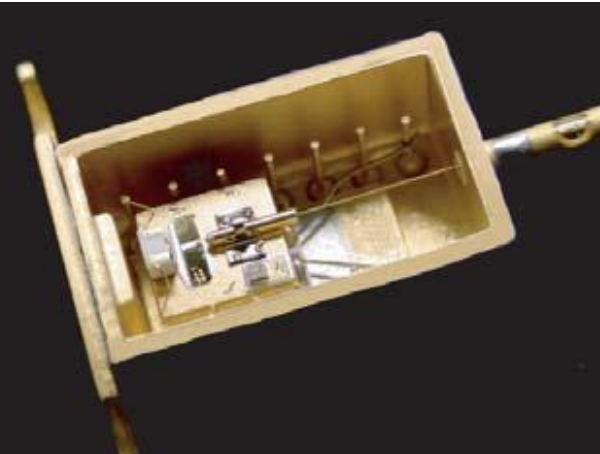
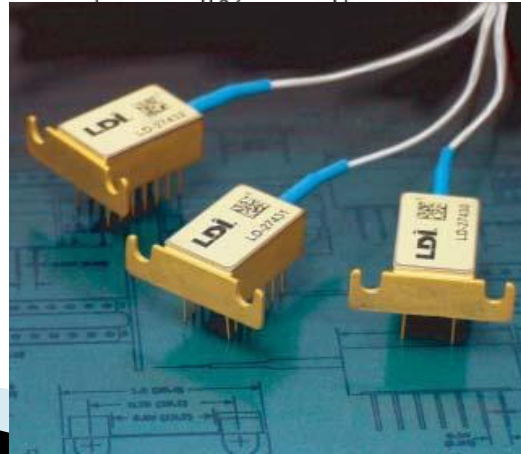

1550nm MQW Laser

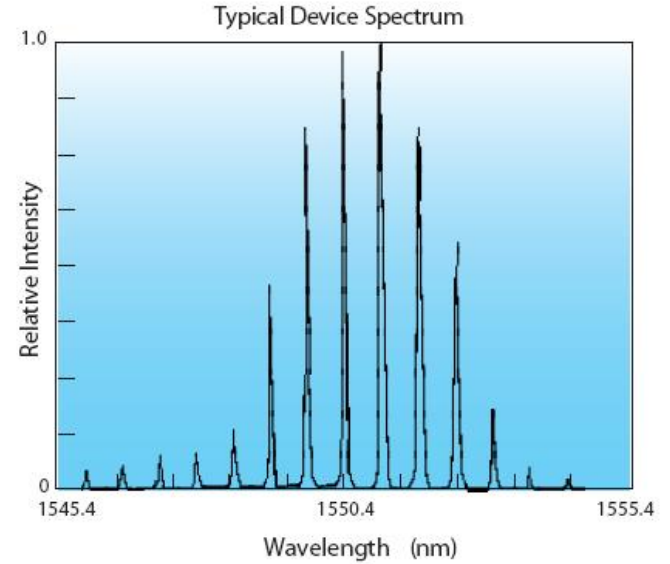
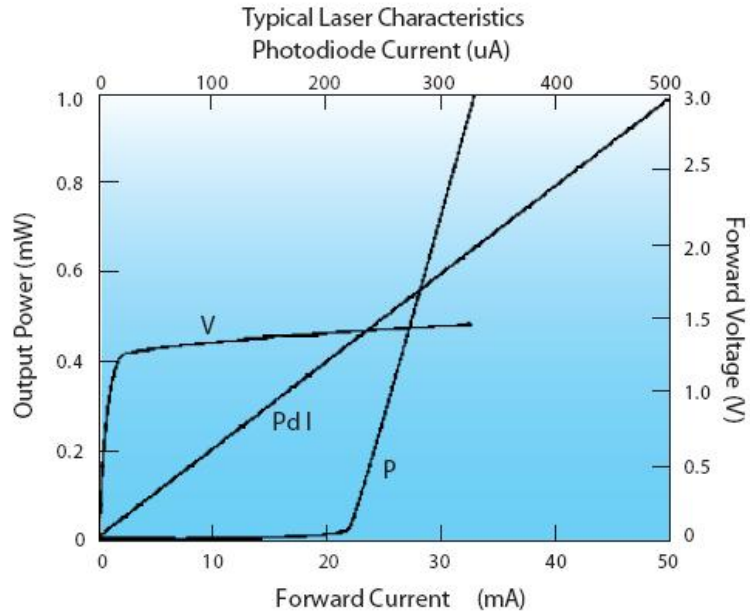

EDFA

▶ Erbium Doped Fiber Amplifier

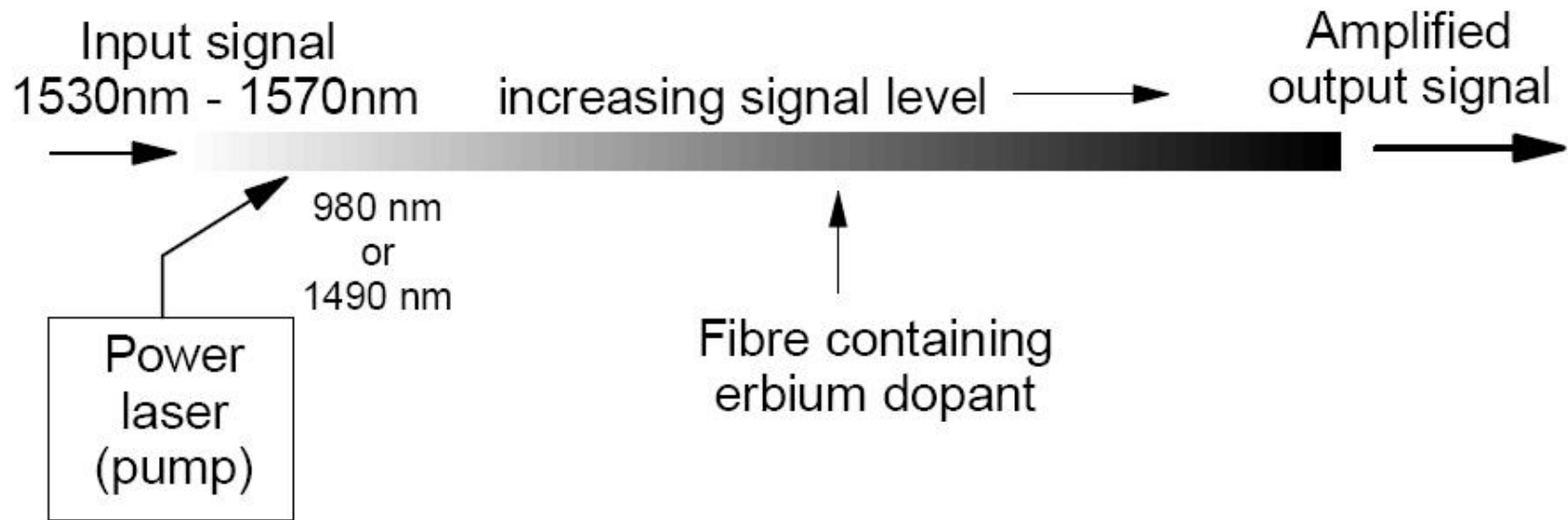

EDFA

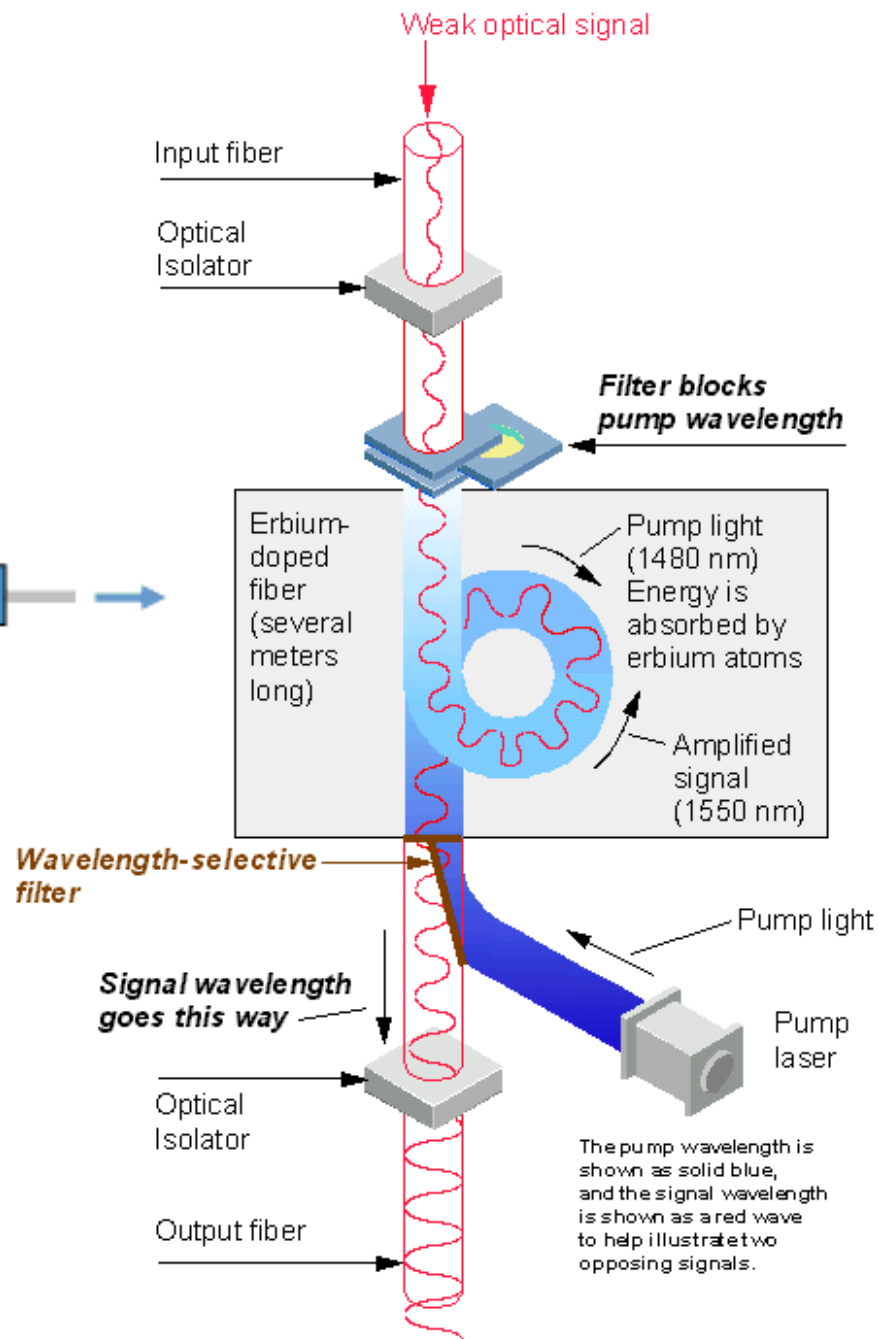
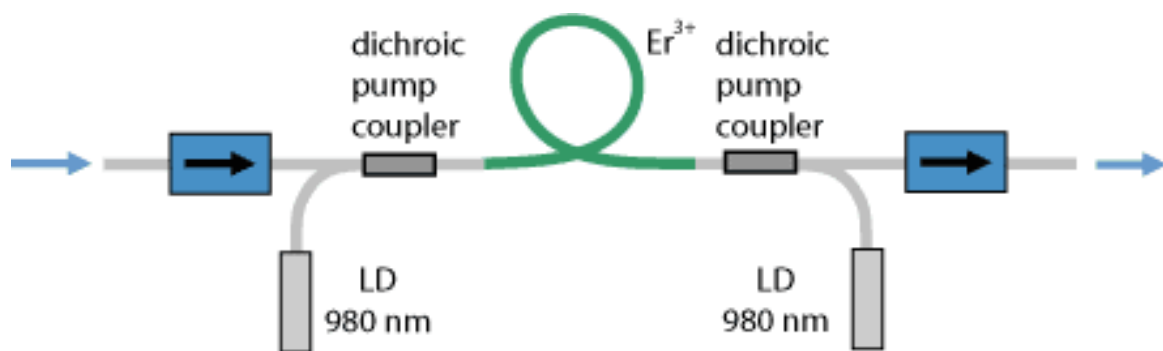

EDFA

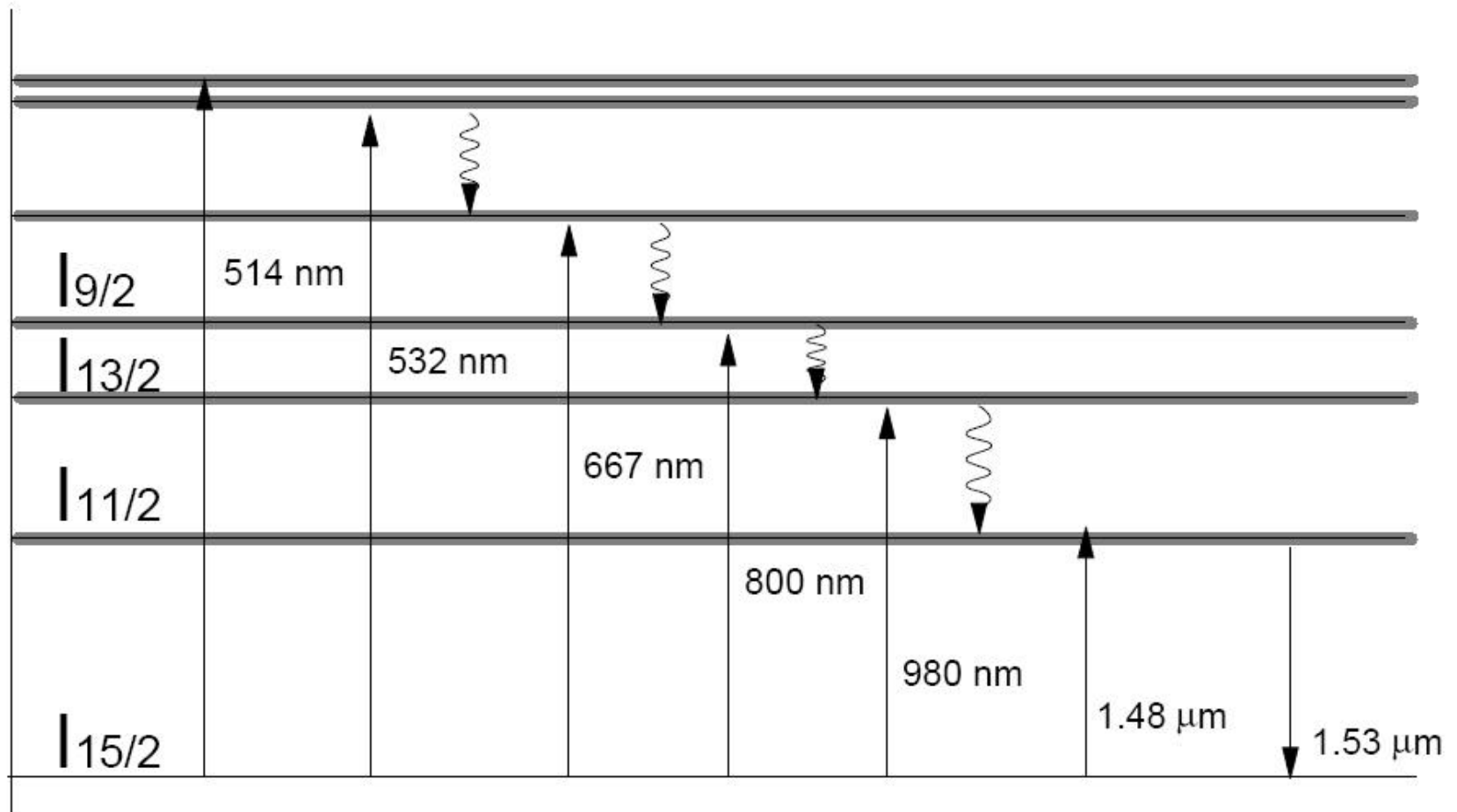

EDFA

How to think of an EDFA

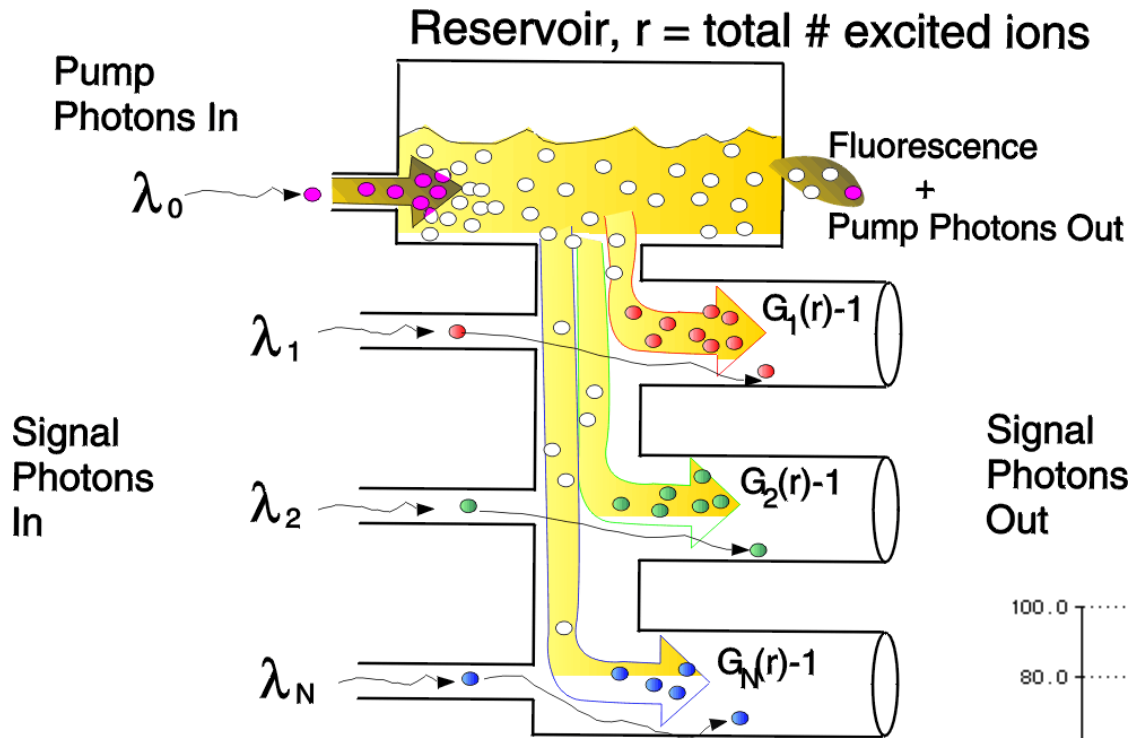

Signal Photons Out

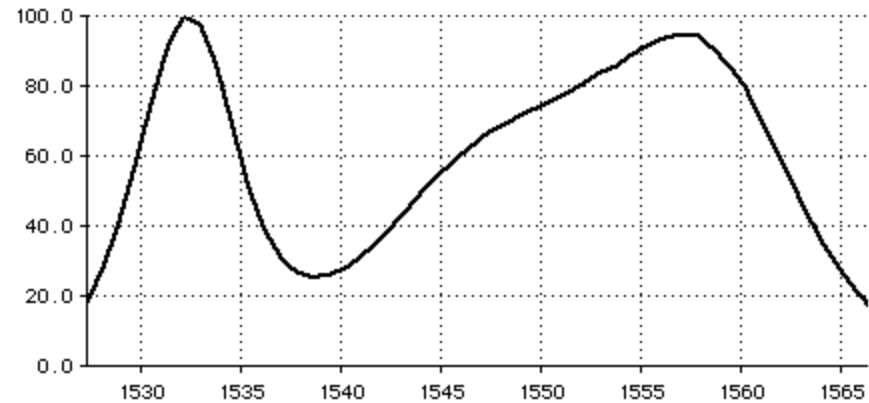

7W 980 nm Multimode Pump Laser

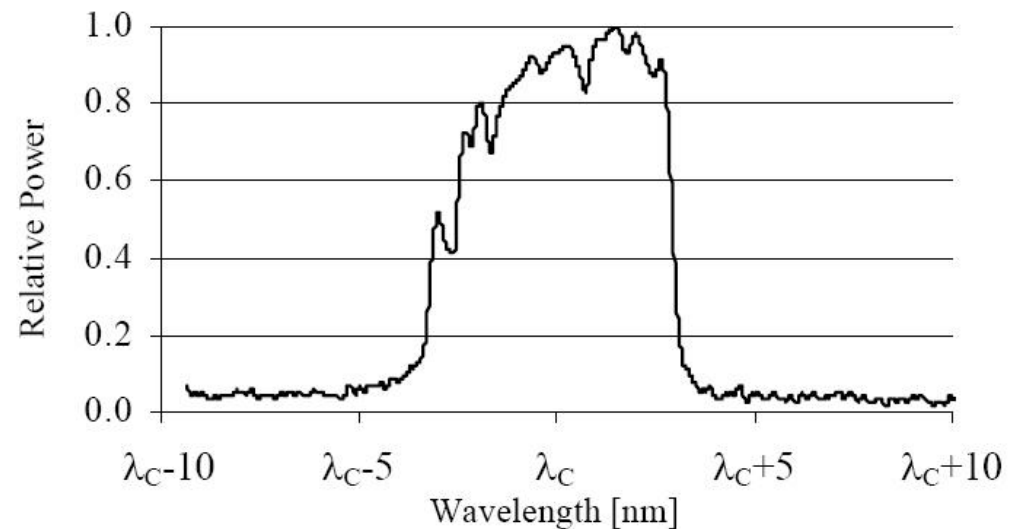
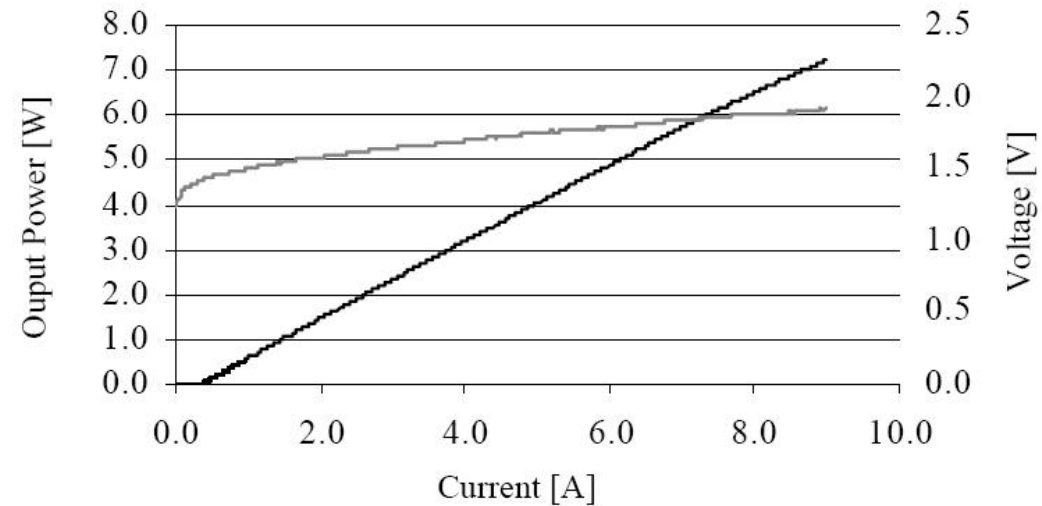
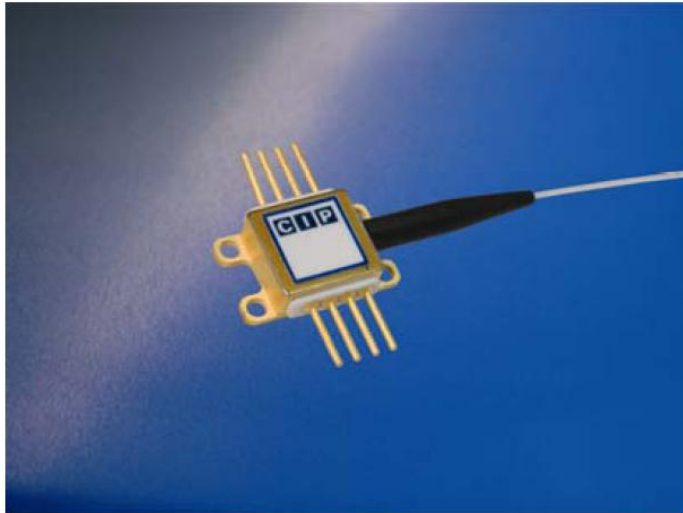

600mW 980 nm Singlemode Pump Laser

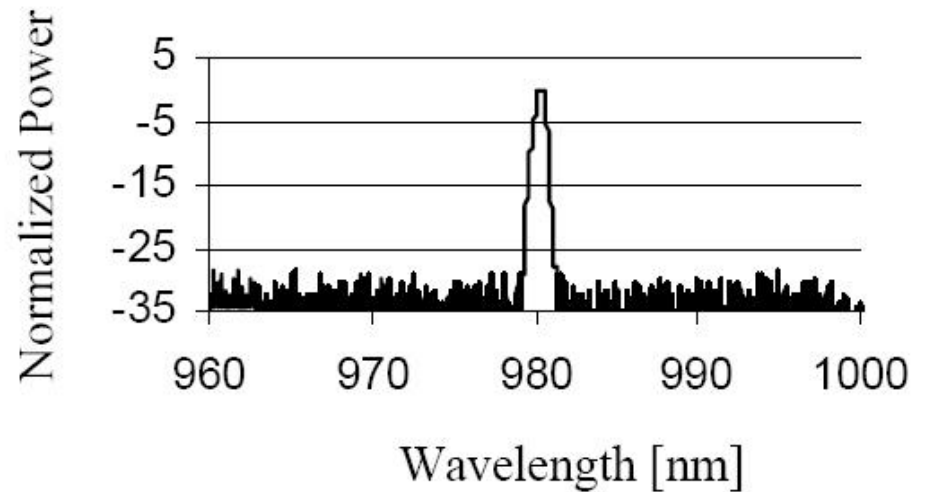
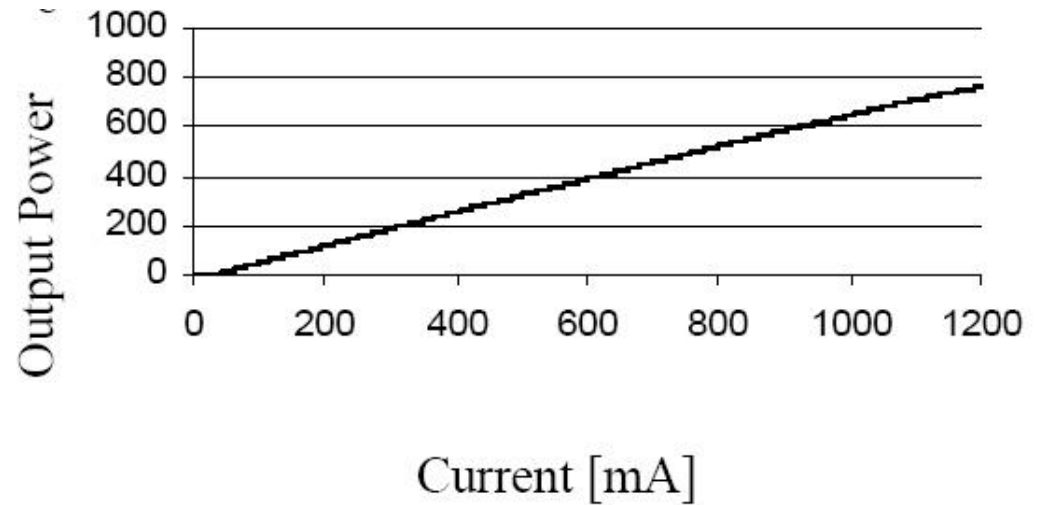
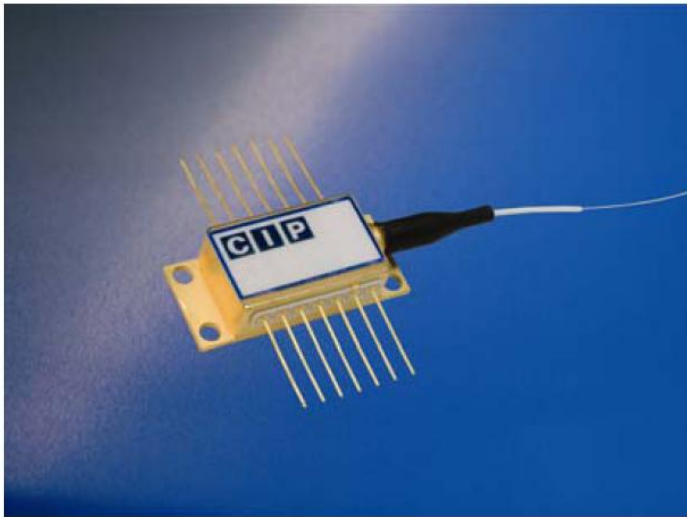

6 W, CW, 800nm

C-Mount Package

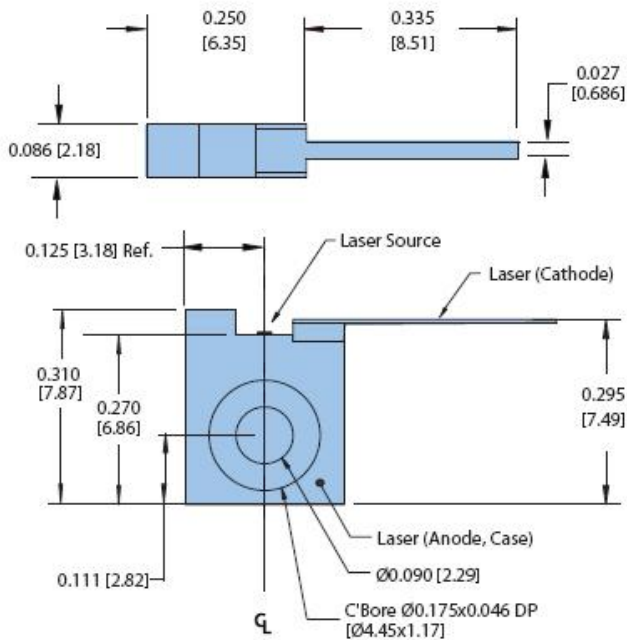

9mm Package

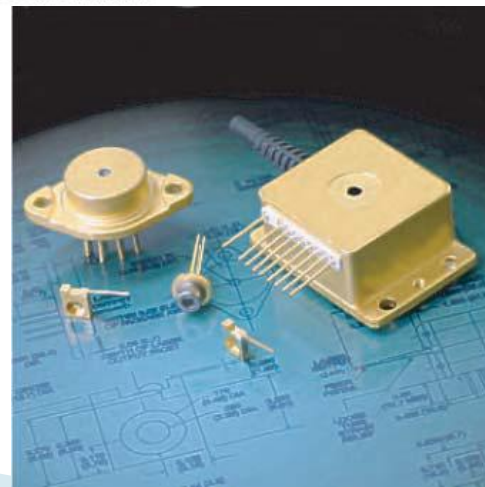
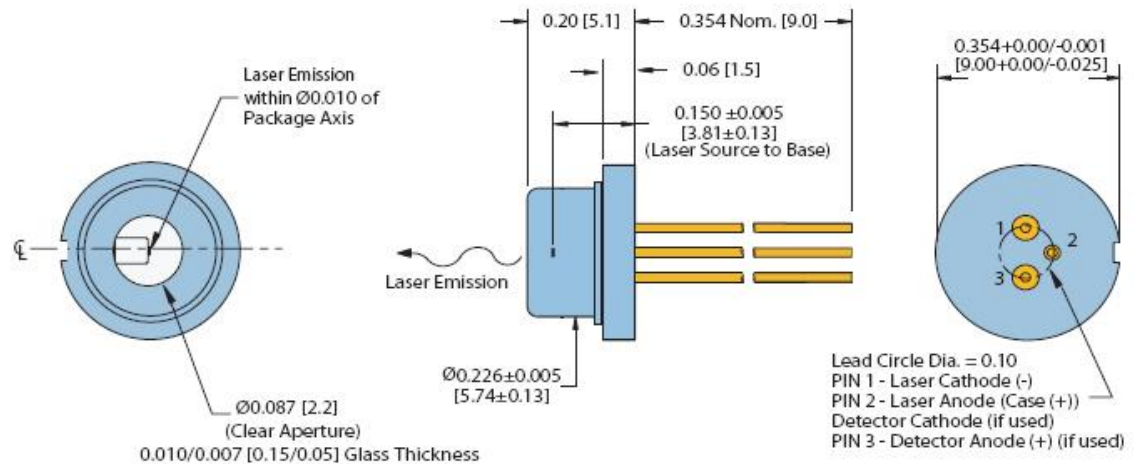

6 W, CW, 800nm

Typical L/I, V/I Graph

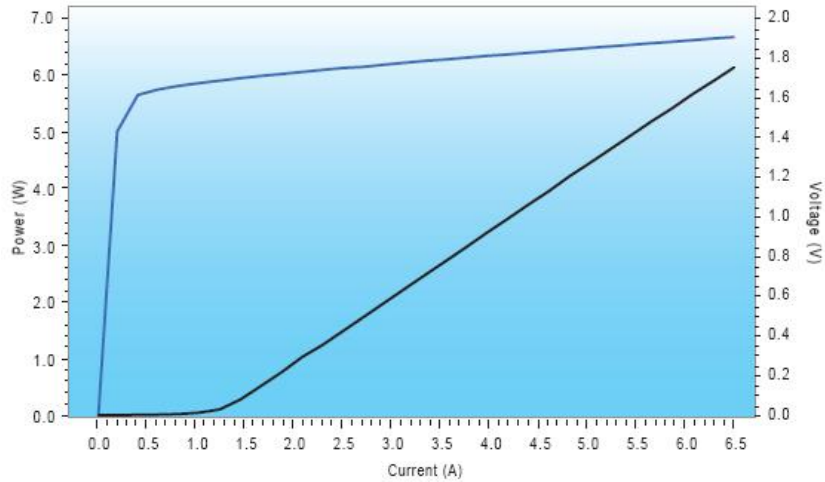

Wavelength Distribution

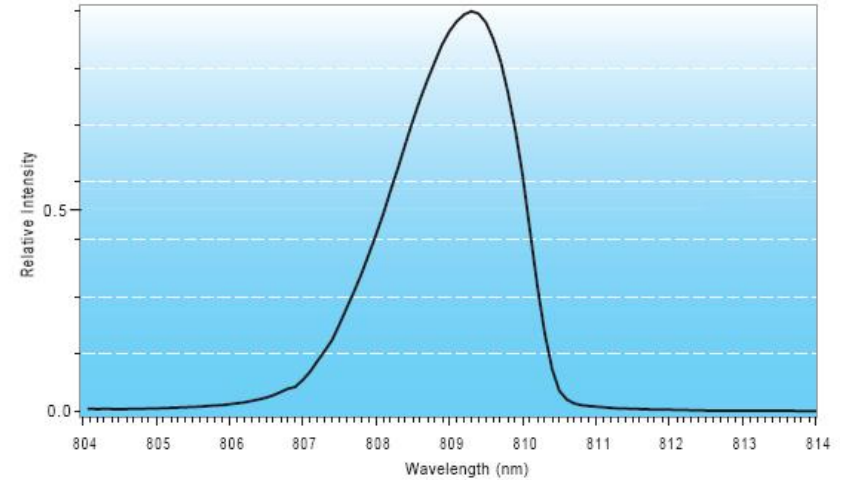

Typical Beam Divergence

Parallel

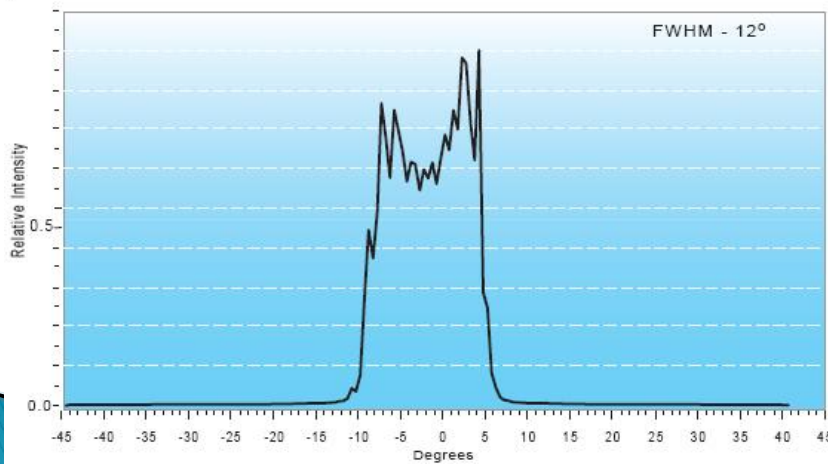

Typical Beam Divergence

Perpendicular

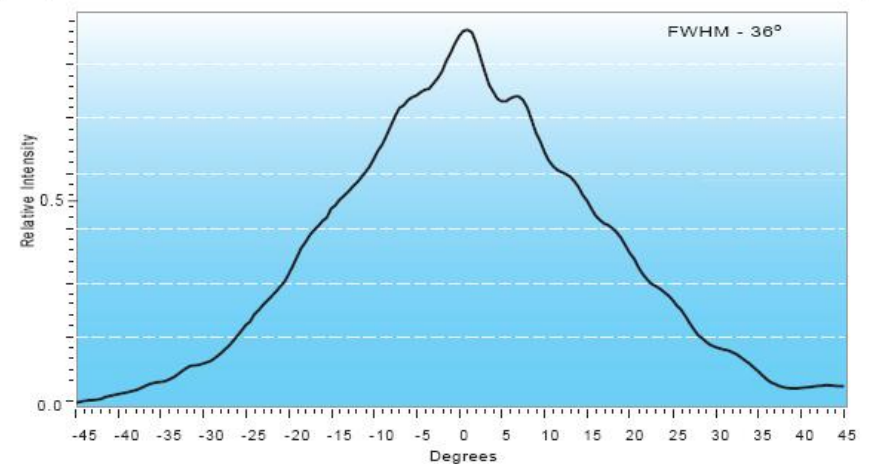

CW Laser, 650 nm

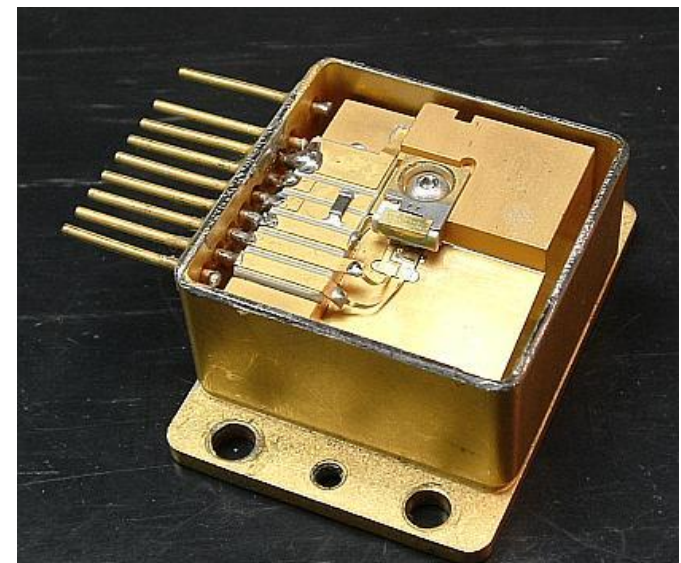
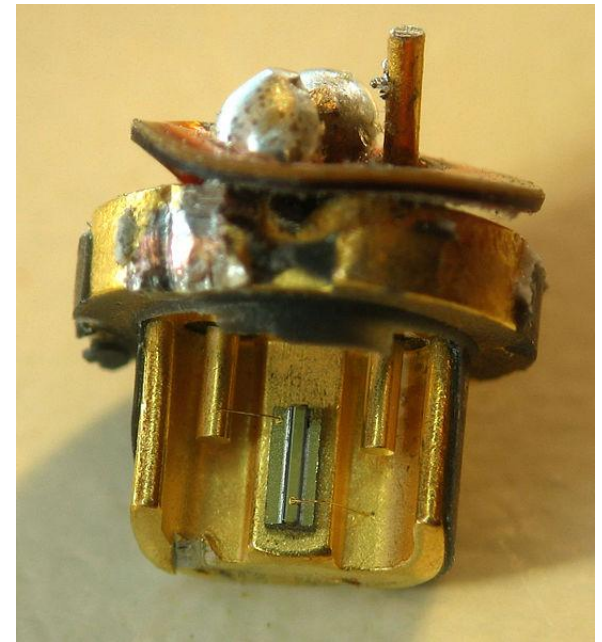
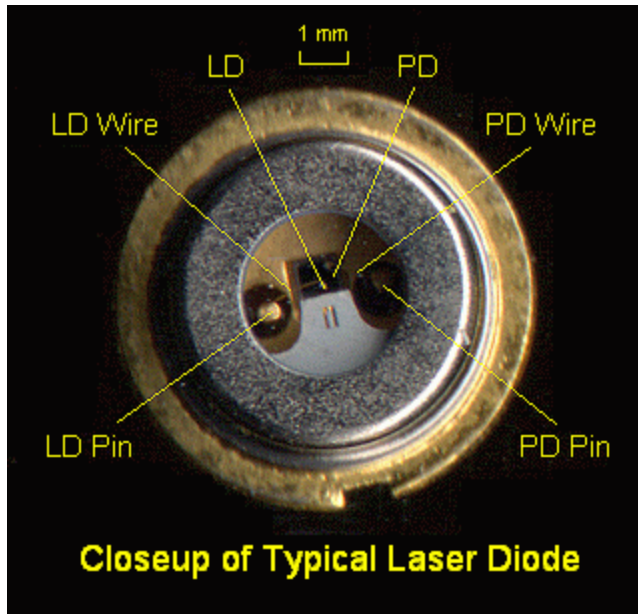

Control dioda LASER

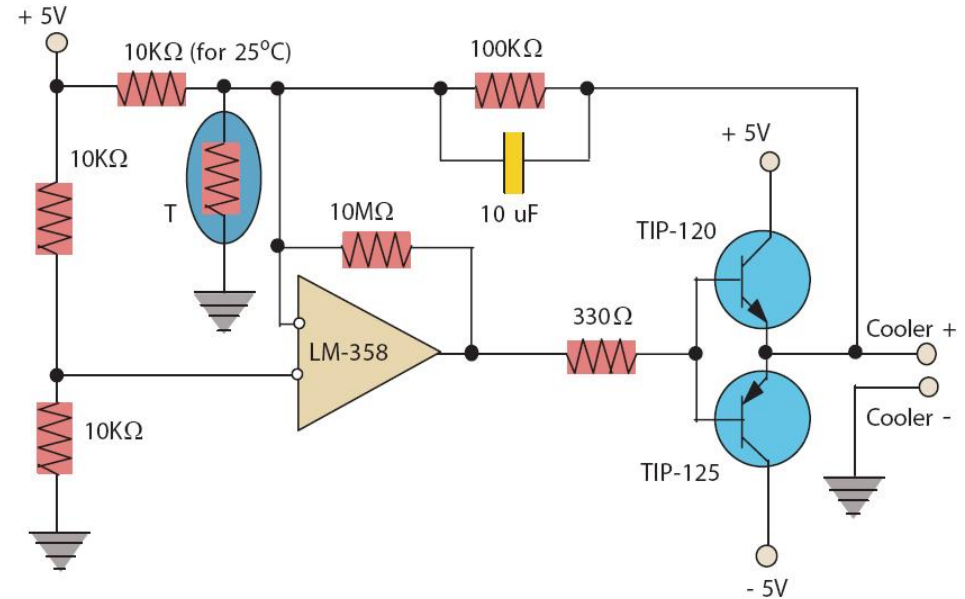
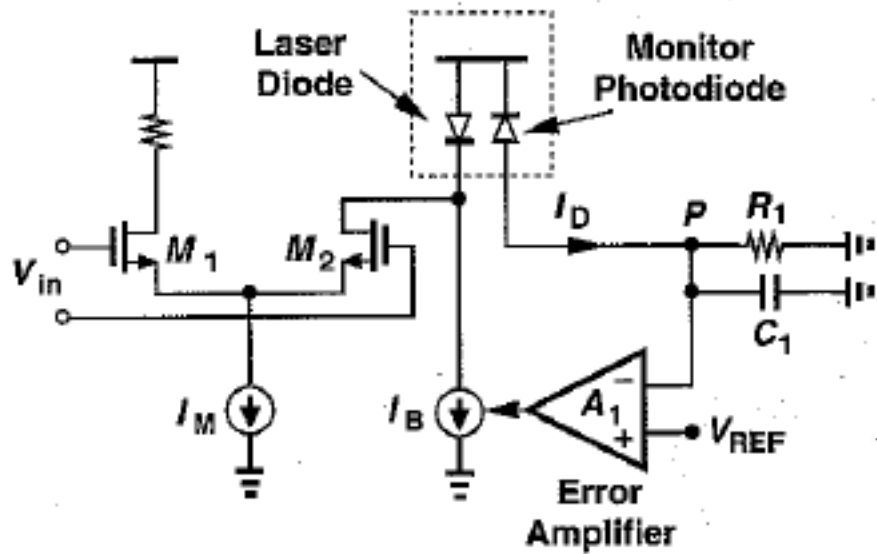

Fotodioda

Capitolul 10

Detectori optici

▶ Cerinte

- eficienta crescuta a conversiei optic/electric
- zgomot redus
- raspuns uniform la diferite lungimi de unda
- viteza de raspuns ridicata
- liniaritate

▶ Principii de operare

- fotoconductori $R = R(P_o)$
- fototranzistori $I_B = I_B(P_o)$
- fotodiode $I = I(P_o)$
 - pn
 - pin
 - pin cu multiplicare in avalansa
 - Schottky

Fotoconductor

▶ Principiu

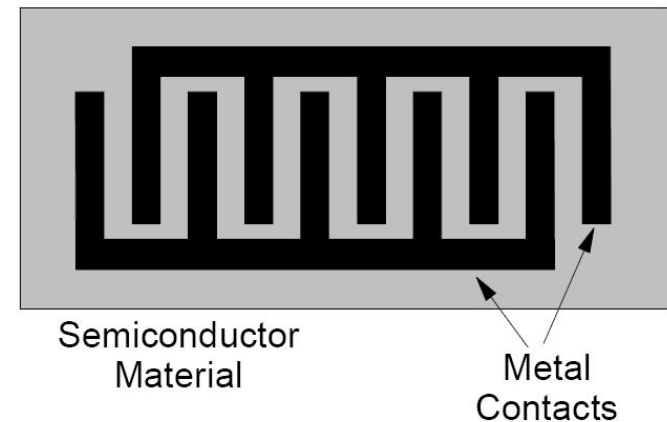
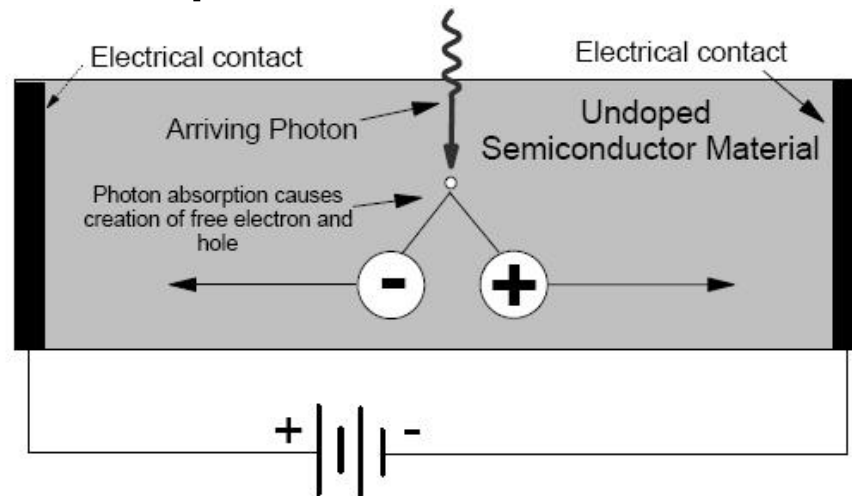

- ▶ Recent dispozitive Metal Semiconductor Metal (filtru interdigital) au inceput sa fie utilizate pentru usurinta de fabricare si integrare in aplicatii mai putin pretentioase

Fotodioda – Principiul de operare

- ▶ Jonctiunea pn este polarizata invers
- ▶ Lumina este absorbita in regiunea golita de purtatori, un foton absorbit generand o pereche electron-gol
- ▶ Sarcinile sunt separate de campul electric existent in regiunea golita si genereaza un curent in circuitul exterior

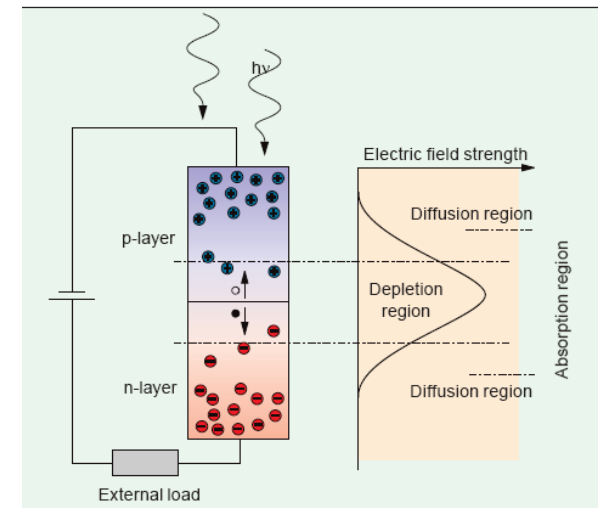
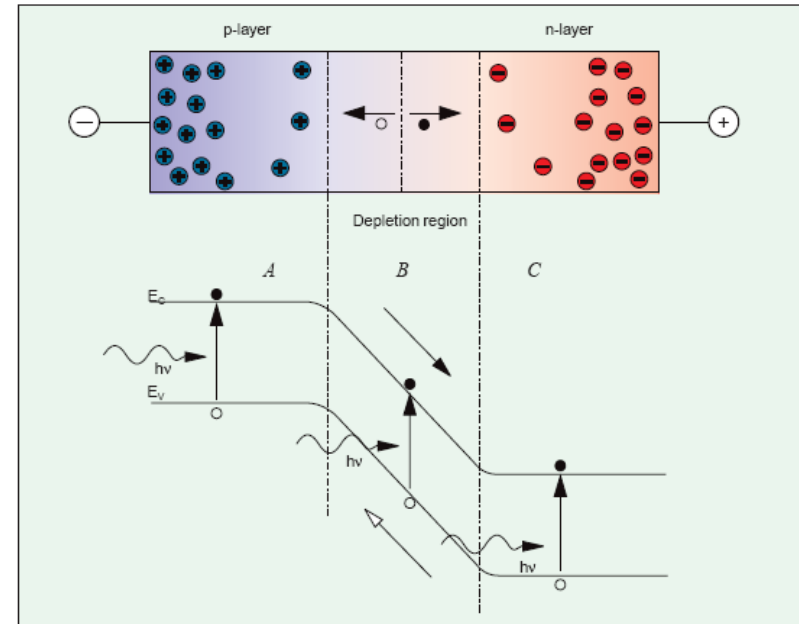

Fotodioda – Principiul de operare

- ▶ Energia necesara pentru eliberarea unei perechi electron gol

$$h\nu = \frac{hc}{\lambda} \geq E_g$$

- ▶ Lungime de unda de taiere

$$\lambda_{\max} = \frac{hc}{E_g}$$

- ▶ Puterea optica absorbita in zona golita de purtatori (w) aflata la o adincime d in interiorul dispozitivului

$$P(w) = P_i \cdot e^{-\alpha \cdot d} \cdot (1 - e^{-\alpha \cdot w}) \cdot (1 - R_f)$$

Fotodioda – Principiul de operare

- ▶ Coeficientul de absorbtie pentru materialele uzuale
- ▶ Valoarea mare a coeficientului de absorbtie la lungimi de unda reduse implica scaderea rezponzivitatii
- ▶ Ca urmare comportarea **tuturor** materialelor este de tip trece banda

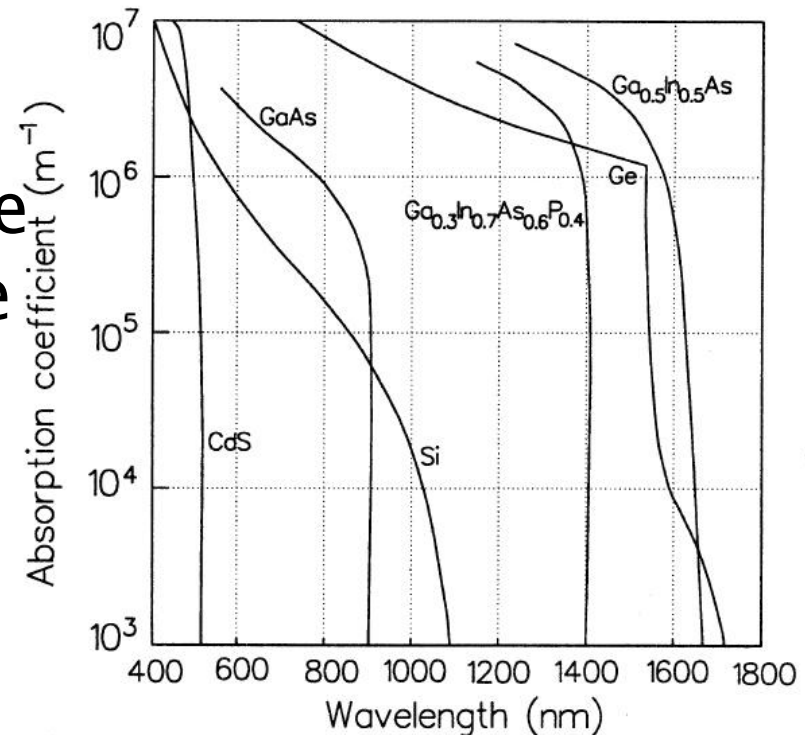

Material utilizate pentru fotodiode

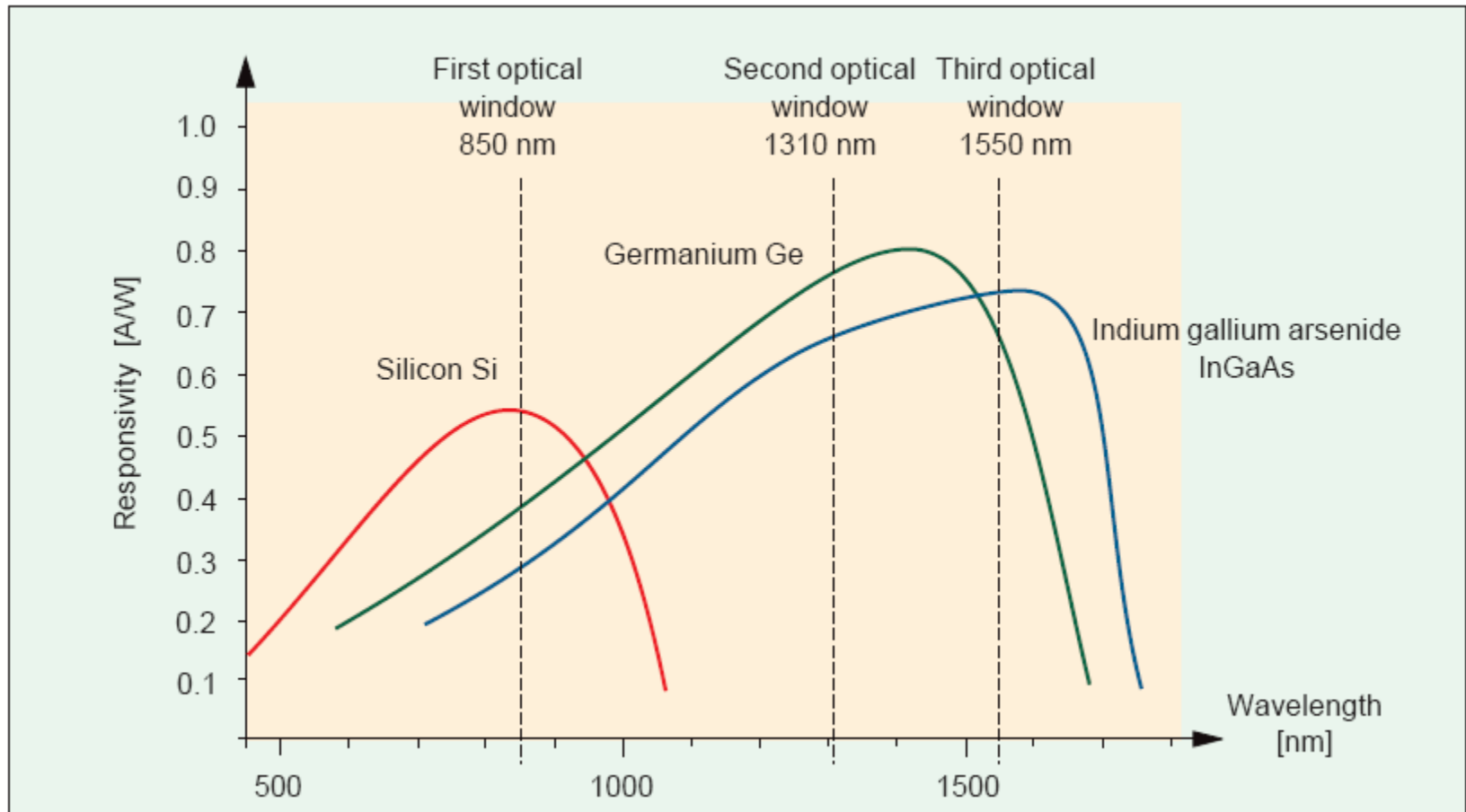

Fotodioda – Marimi caracteristice

- ▶ Eficienta cuantica – raportul dintre numărul de perechi electron–gol generate și numărul de fotoni incidenti

$$\eta = \frac{n_e}{n_f}$$

- ▶ In unitatea de timp numarul de fotoni depinde de puterea optica, iar numarul de electroni impune curentul generat

$$\eta = \frac{I/e}{P/h\nu}$$

- ▶ Responzivitatea

$$R = \frac{I}{P_o} = \frac{\eta \cdot e \cdot \lambda}{hc}$$

$$R = 0.8 \cdot \eta \cdot \lambda [\mu m] \left[\frac{A}{W} \right]$$

Fotodiode - marimi caractéristice

$$R = \frac{I}{P_o} = \eta \cdot \frac{e}{hc} \cdot \lambda$$

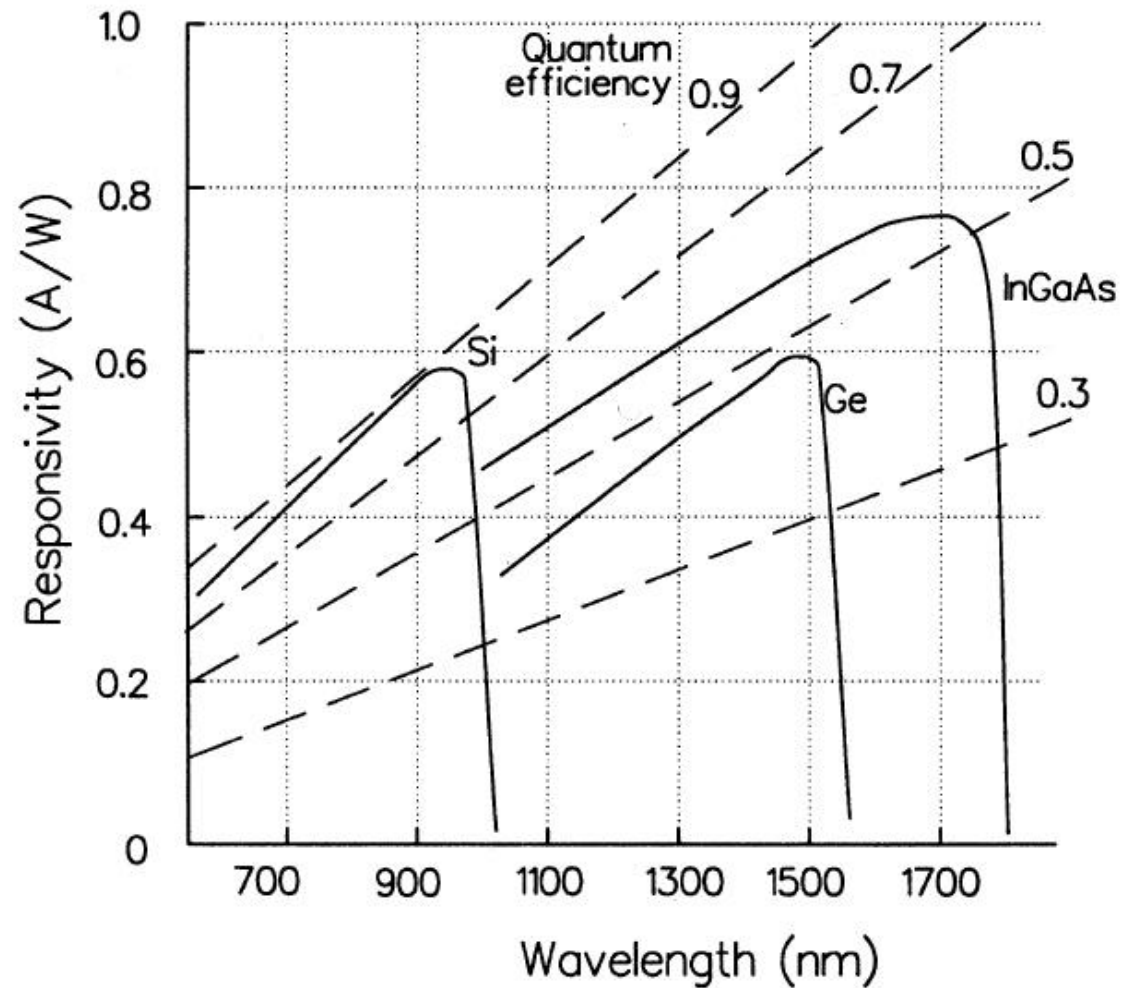

Material utilizate pentru fotodiode

Material	λ [μm]	Responsivitate [A/W]	Viteza [ns]	Curent de intuneric
Si	0.85	0.55	3	1
Si	0.65	0.4	3	1
InGaAs	1.3–1.6	0.95	0.2	3
Ge	1.55	0.9	3	66

- ▶ Dezavantajul major pentru Ge este curentul de intuneric mare

Material	E_g (eV)
GaAs	1.43
GaSb	0.73
$\text{GaAs}_{0.88}\text{Sb}_{0.12}$	1.15
Ge	0.67
InAs	0.35
InP	1.35
$\text{In}_{0.53}\text{Ga}_{0.47}\text{As}$	0.75
$\text{In}_{0.14}\text{Ga}_{0.86}\text{As}$	1.15
Si	1.14

Curent de intuneric

- ▶ Curentul invers al jonctiunii p-n, datorat agitatiei termice, prezent in absenta iluminarii
- ▶ Constitutie o importanta sursa de zgomot (limiteaza aplicatiile Ge)

$$I_D = I_S \approx \frac{\beta \cdot kT}{eR_0}$$

- β – coeficient de idealitate $\beta = 1 \div 2$
- R_0 – rezistenta la intuneric a diodei (invers proportionala cu aria diodei)

Fotodioda PIN

- ▶ Existenta campului electric in regiunea golita de purtatori face ca eventualii purtatori generati optic sa fie accelerati spre terminale pentru constituirea fotocurentului
- ▶ Problemele utilizarii diodei pn polarizate invers ca fotodetector sunt generate de adancimea extrem de mica a zonei golite (w)
- ▶ Puterea optica absorbita in interiorul acestei zone e in consecinta redusa
- ▶ Puratorii generati inafara zonei de golire ajung eventual in zona golita si vor fi accelerati spre terminale, dar viteza fenomenului este prea redusa pentru aplicatii in comunicatii

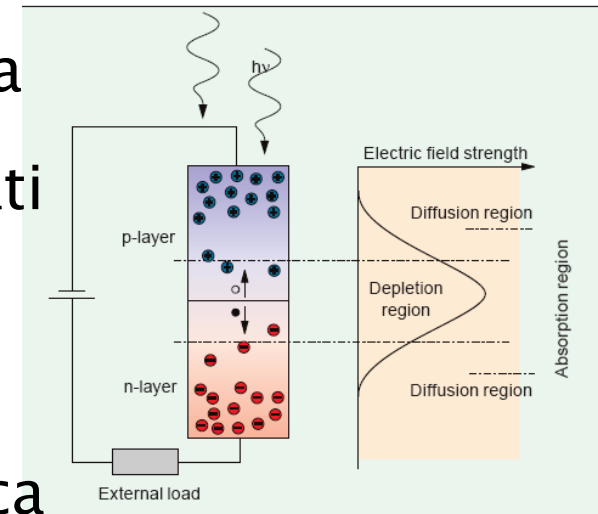

Fotodioda PIN

- ▶ Solutia consta in introducerea unui strat foarte slab dopat (intrinsec) intre cele doua zone ale diodei
 - creste volumul de absorbtie deci creste sensibilitatea fotodiodei
 - capacitatea jonctiunii scade ducand la cresterea vitezei
 - este favorizat curentul de conductie (mai rapid) fata de cel de difuzie

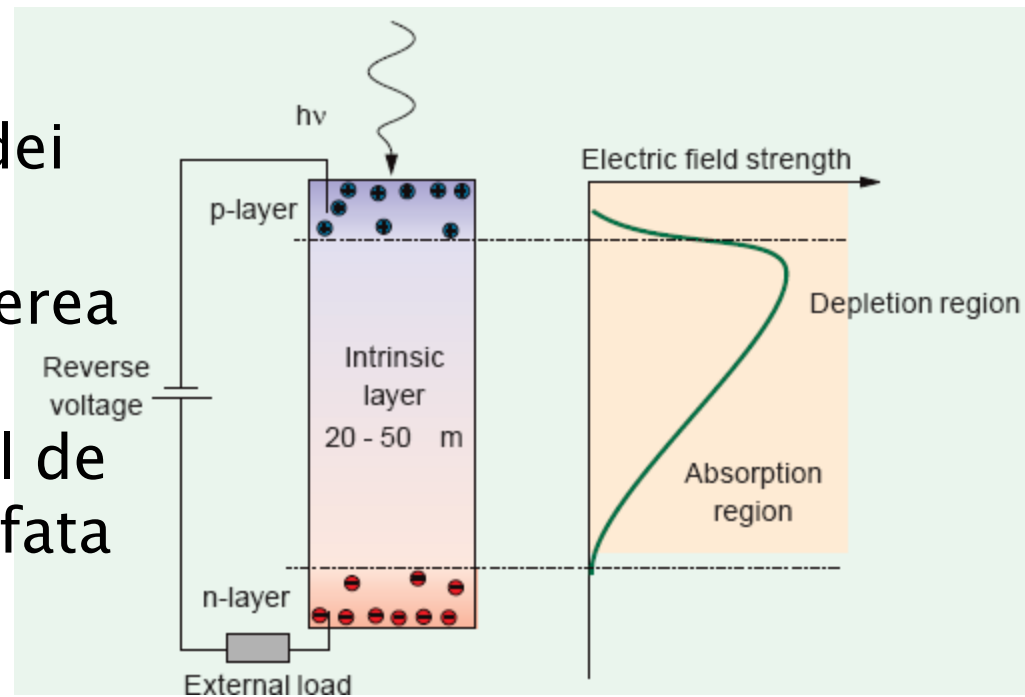

Structura fotodiodei PIN

- ▶ tipic, adancimea stratului intrinsec este de 20–50 μm
- ▶ cresterea suplimentara a adancimii ar duce la creterea timpului de tranzit
 - $w=20\mu\text{m} \rightarrow T_{tr} \cong 0.2\text{ns}$

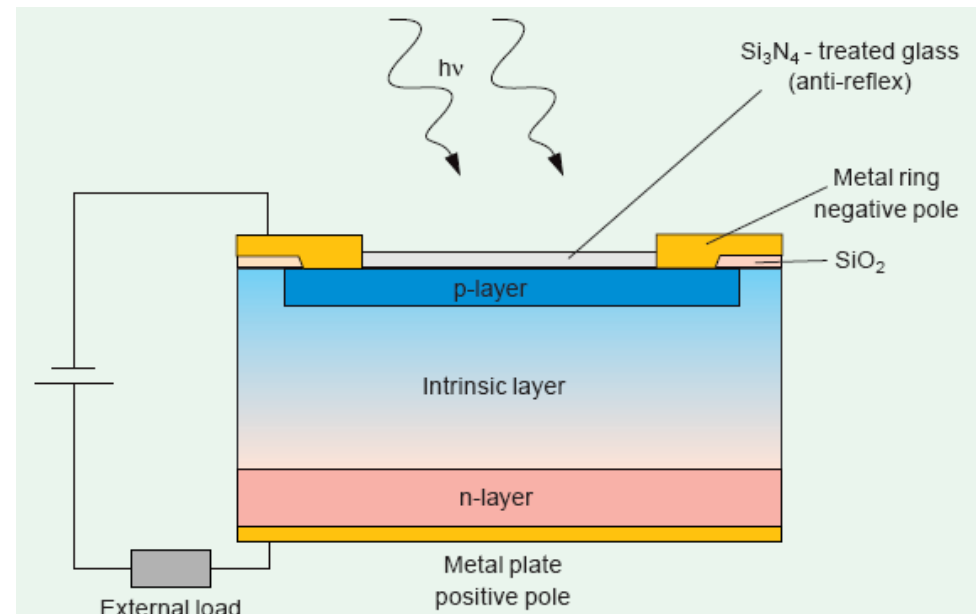
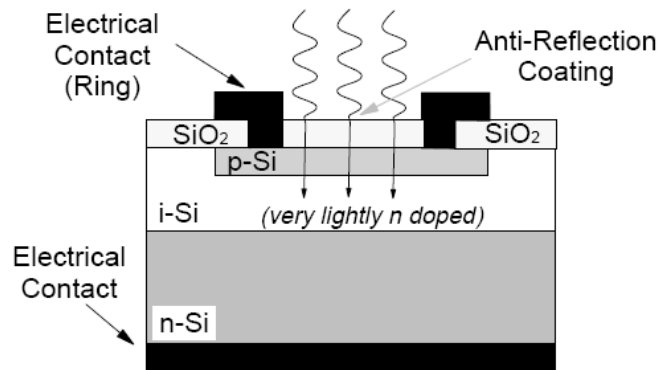

Structura fotodiodelor Schottky

- ▶ se bazeaza pe jonctiunea metal semiconductor
- ▶ vitezele de lucru sunt mult mai mari, metalul fiind un bun conductor realizeaza evacuarea mult mai rapida a purtatorilor din jonctiune
- ▶ permite utilizarea unor materiale cu eficienta mai mare dar care nu pot fi dopate simultan p si n pentru utilizare in PIN
- ▶ modulatie cu 100GHz posibila

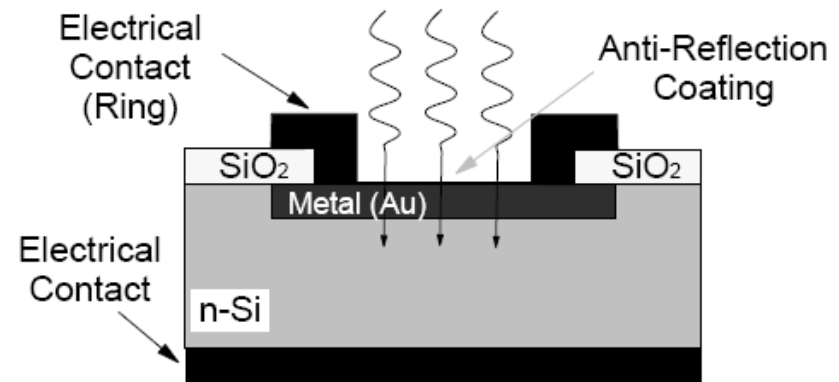

Fotodioda PIN pentru lungimi de unda crescute (1550nm)

- ▶ se utilizeaza tipic
 - InGaAsP pe substrat InP
 - GaAlAsSb pe substrat GaSb

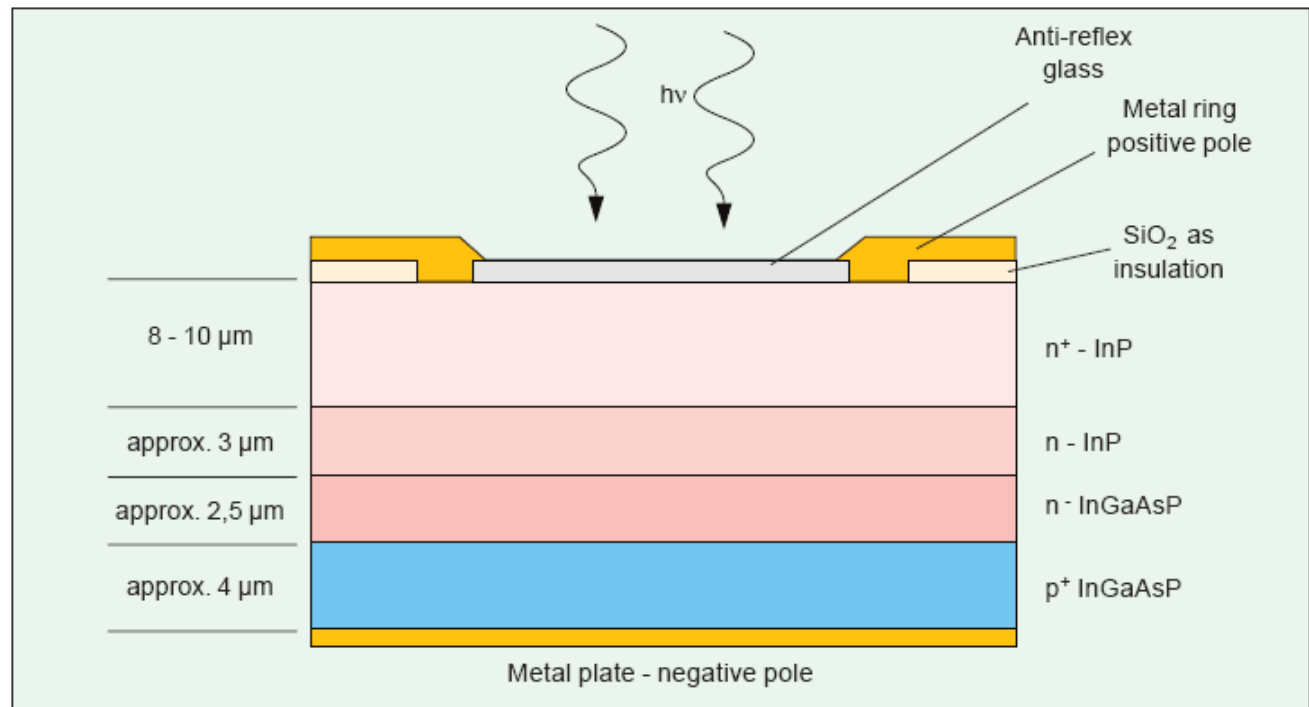

Caracteristici curent/tensiune

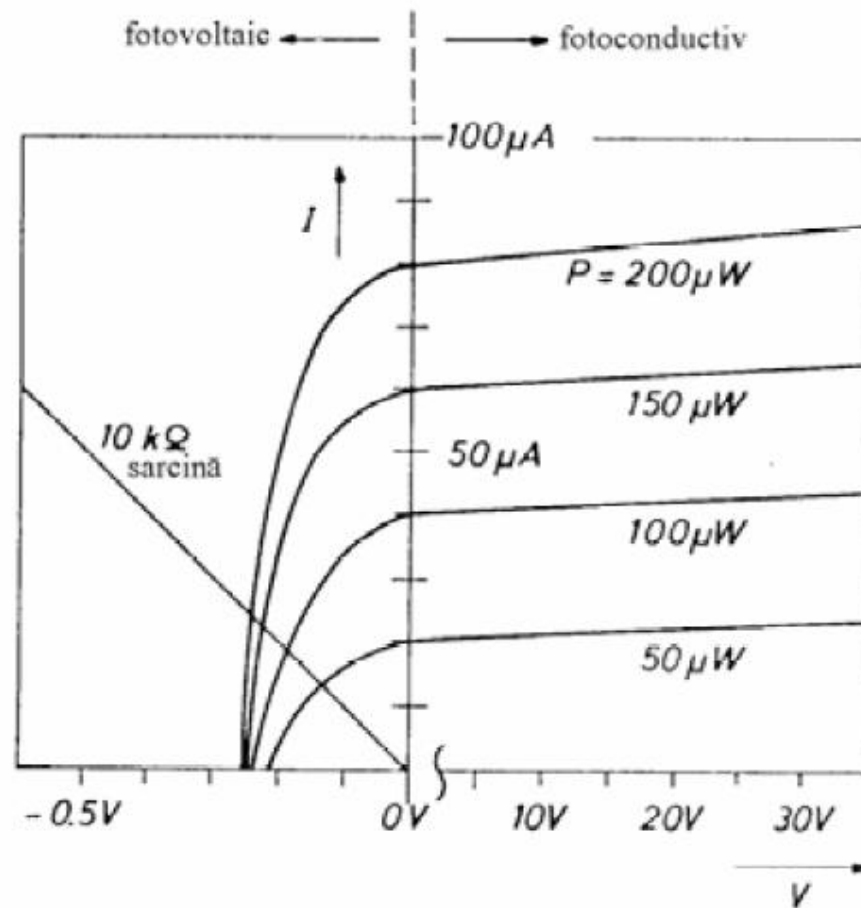

Fotodioda PIN cu multiplicare in avalansa

- ▶ daca viteza purtatorilor este suficient de mare genereaza noi perechi electron/gol prin ionizare de impact
- ▶ amplificarea are loc in acelasi timp cu detectia

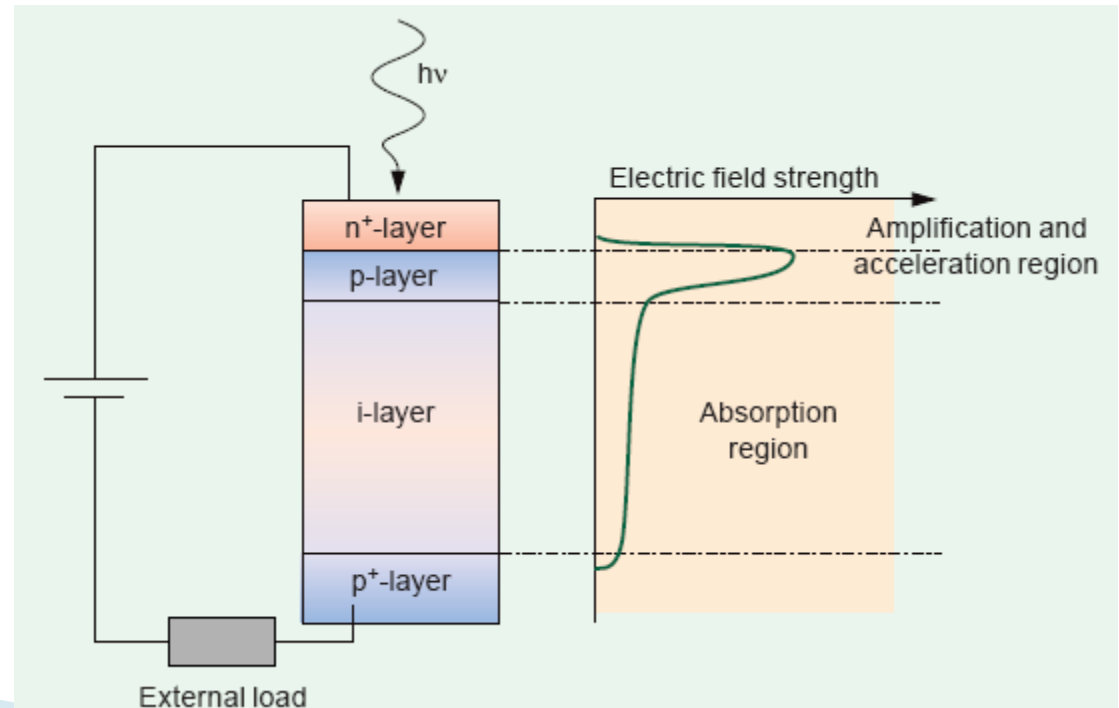
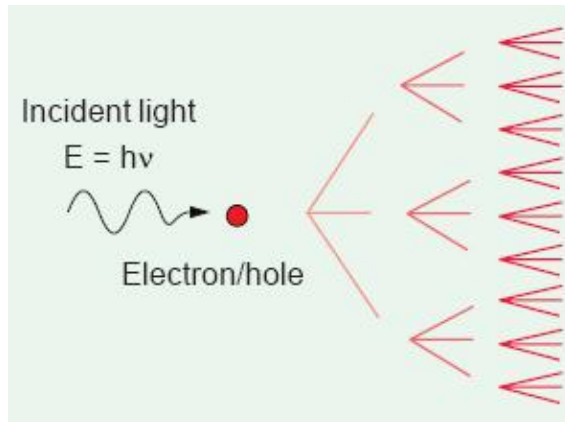

Functionarea fotodiodei cu multiplicare in avalansa

- ▶ campuri electrice de ordinul minim: 3×10^5 V/m, tipic: 10^6 V/m sunt necesare
- ▶ aceste campuri sunt generate de tensiuni inverse de polarizare de ordinul 50–300V
- ▶ structura este modificata pentru concentrarea campului in zona de accelerare

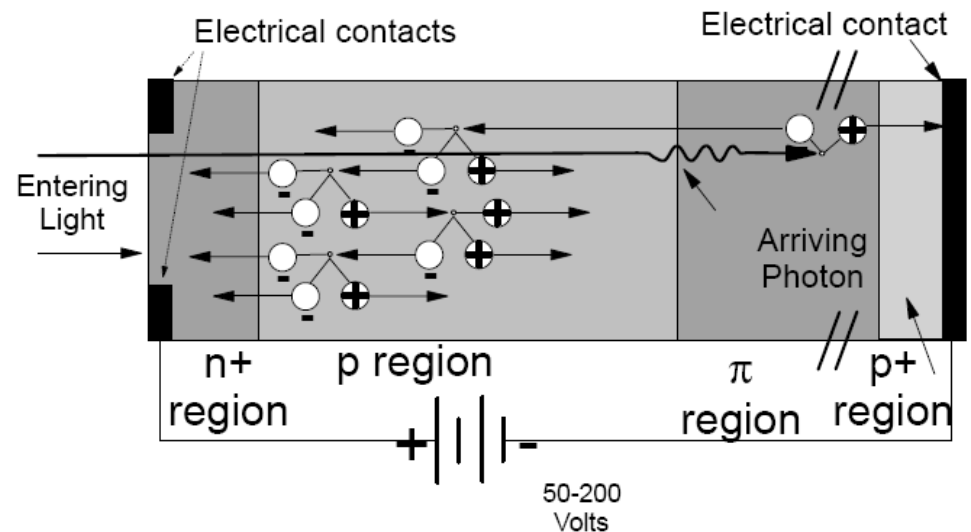
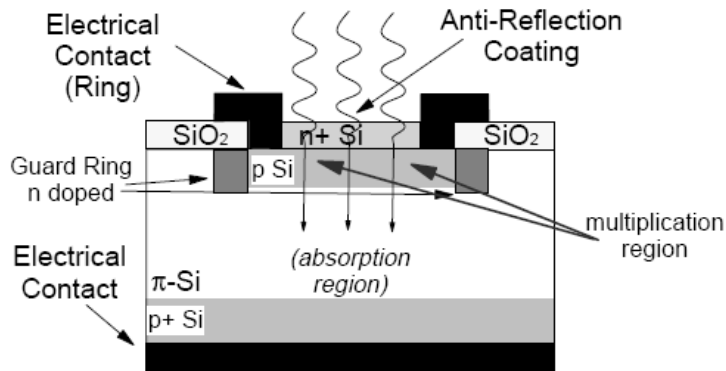

Structura fotodiodei cu multiplicare in avalansa

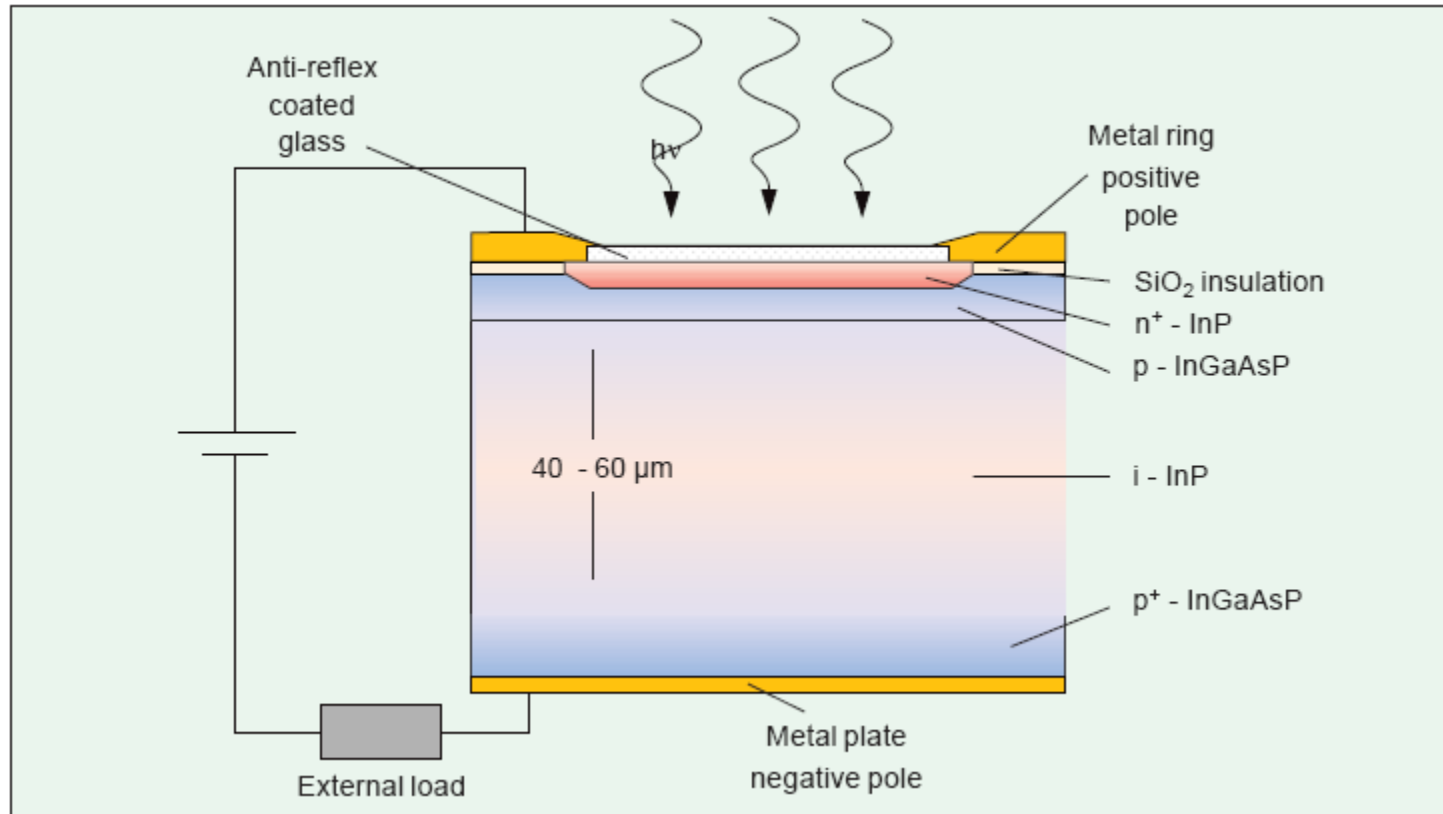

Caracteristicile fotodiodei cu multiplicare in avalansa

- ▶ factorul de multiplicare caracterizeaza amplificarea fotocurentului generat

$$M = \frac{I_M}{I}$$

- ▶ Responzivitatea

$$R = \frac{I}{P_o} = \frac{\eta \cdot e \cdot \lambda}{hc} \cdot M$$

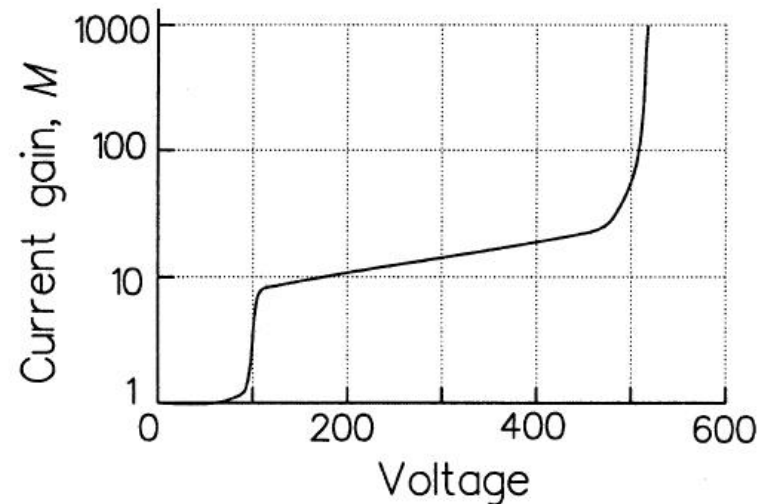

Dezavantaje

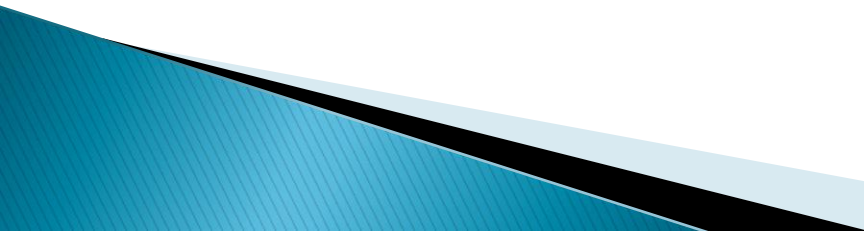
- ▶ tensiuni inverse de polarizare mari cresc complexitatea circuitului
 - ▶ diodele cu multiplicare in avalansa sunt intrinsec mai zgomotoase (curentul de zgomot este amplificat de asemenea)
 - ▶ factorul de multiplicatie are o componenta aleatorie (zgomot suplimentar)
 - ▶ viteza mai redusa (timp de generare al avalansei)
- 

Limite putere/bandă a dispozitivelor optoelectronice

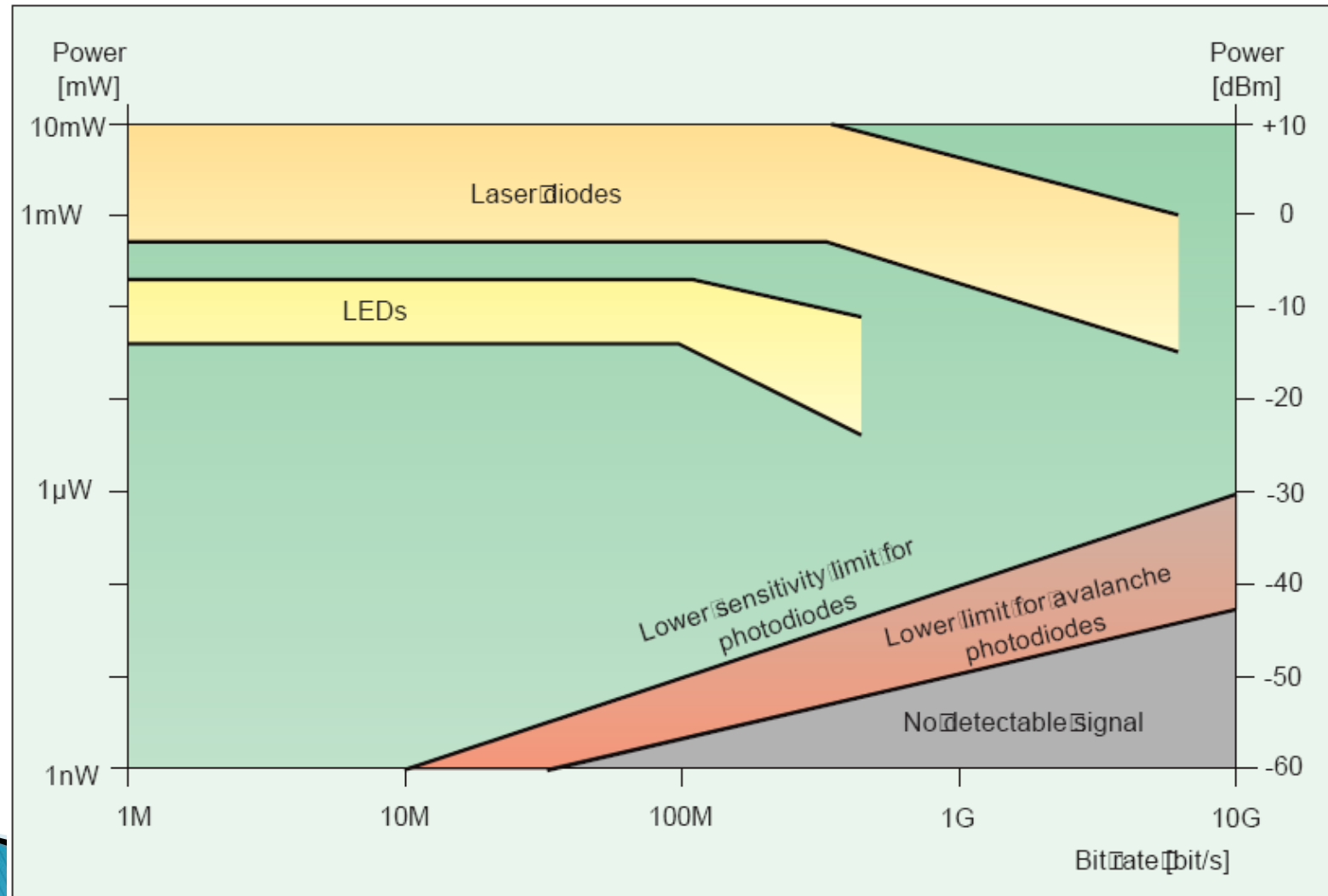

Contact

- ▶ Laboratorul de microunde si optoelectronica
- ▶ <http://rf-opto.etti.tuiasi.ro>
- ▶ rdamian@etti.tuiasi.ro