

Optoelectronică

Curs 7

2021 / 2022

Disciplina 2021 / 2022

- ▶ 2C/1L Optoelectronică **OPTO**
- ▶ **Minim 7 prezente curs + laborator**
- ▶ Curs – conf. **Radu Damian**
 - an IV μ E
 - Luni 08(:10)–10:00, **P5**, ~~Microsoft Teams~~
 - E – 70% din nota (50+20), P5
 - **20% test (VP) la curs**, saptamana 6?
 - probleme + (2p prez. curs)
 - toate materialele permise
- ▶ Laborator – **sl. Daniel Matasaru**
 - an IV μ E
 - Marti 14-18 impar/par
 - Max. 7 prezente
 - L – 30% din nota (+Caiet de laborator)

Orar 2021 / 2022

▶ Curs

- Luni 8-10, P5, 3pz = 0.5p bonus, poate **P2**

~~◦ 2C ⇒ 3C~~

~~• $14 * 2/3 \approx 9.33$~~

~~• $9 : 10 C \approx 9C + E$~~

Online

- ▶ acces la **examene** necesita **parola** primita prin **email**

English | Romana |

Start Didactic Master Colectiv Cercetare Stud

Note Lista Studenti Examene Fotografii

POPESCU GOPO ION

Fotografia nu exista

Date:

Grupa	5700 (2019/2020)
Specializarea	Inginerie electronica si telecomunicatii
Marca	7000021

Acceseaza ca acest student | [cere acces la licente](#)

Note obtinute

Inca nu a fost notat.

Start Didactic Master Colectiv C

Note Lista Studenti Examene Fotografii

Identificare

Introduceti numele si adresa de email utilizata la inscriere

Nume
POPESCU GOPO

E-mail/Parola

Introduceti codul afisat mai jos

4db4457

Trimite

Online

- ▶ acces email/parola

Start Didactic Master Colectiv

Note Lista Studenti Examene Fotografii

POPESCU GOPO ION

Fotografia nu exista

Date:

Grupa	5700 (2019/2020)
Specializarea	Inginerie electronica
Marca	7000021

Se acceseaza site-ul [ca acest student!](#)

Start Didactic Master Colectiv C

Note Lista Studenti Examene Fotografii

POPESCU GOPO ION

Fotografia nu exista

Date:

Grupa	5700 (2019/2020)
Specializarea	Inginerie electronica s
Marca	7000021

Se acceseaza site-ul [ca acest student \(inclusiv examene\)!](#)

Parola

▶ primita prin email

Important message from RF-OPTO

Inbox x



Radu-Florin Damian

to me, POPESCU

Romanian > English Translate message



Laboratorul de Microunde si Optoelectronica
Facultatea de Electronica, Telecomunicatii si Tehnologia Informatiei
Universitatea Tehnica "Gh. Asachi" Iasi

In atentie: POPESCU GOPO ION

Parola pentru a accesa examenele pe server-ul **rf-opto** este

Parola: [REDACTED]

Identificati-va pe [server](#), cu parola, cat mai rapid, pentru confirmare.

Memorati acest mesaj intr-un loc sigur, pentru utilizare ulterioara

Attention: POPESCU GOPO ION

The password to access the exams on the **rf-opto** server is

Password: [REDACTED]

Login to the [server](#), with this password, as soon as possible, for confirmation.

Save this message in a safe place for later use

Reply

Reply all

Forward

Subject

Correspondents

Important message from RF-OPTO → POPESCU GOPO ION

Validation of MIDCR exam from 02/05/2020

From: Me <rdamian@etti.tuiasi.ro>

Subject: Important message from RF-OPTO

To: [REDACTED]

Cc: Me <rdamian@etti.tuiasi.ro>

Laboratorul de Microunde si Optoelectronica
Facultatea de Electronica, Telecomunicatii si Tehnologia Informatiei
Universitatea Tehnica "Gh. Asachi" Iasi

In atentie: POPESCU GOPO ION

Parola pentru a accesa examenele pe server-ul **rf-opto** este

Parola: [REDACTED]

Identificati-va pe [server](#), cu parola, cat mai rapid, pentru confirmare.

Memorati acest mesaj intr-un loc sigur, pentru utilizare ulterioara

Attention: POPESCU GOPO ION

The password to access the exams on the **rf-opto** server is

Password: [REDACTED]

Login to the [server](#), with this password, as soon as possible, for confirmation.

Save this message in a safe place for later use

Manual examen online

- ▶ Aplicatia de examen online utilizata intens la:
 - curs (prezenta)
 - miniteste
 - examen

Materials

Other data

[Manual examen on-line](#) (pdf, 2.65 MB, ro, 🇷🇴)

[Simulare Examen](#) (video) (mp4, 65.12 MB, ro, 🇷🇴)

Microwave Devices and Circuits (Englis

Examen online

- ▶ intotdeauna **contratimp**
 - perioada lunga (prezenta curs/rezultate laborator)
 - perioada scurta (teste: 15min, examen: 2h)

Start Didactic Master Colectiv Cercetare **Studenti**

Note Lista Studenti **Examine** Fotografii

Anunț
17:28 (29/04/2020)

Material suport
17:30 (29/04/2020)

Subiecte
17:32 (29/04/2020)

Rezultate
17:35 (29/04/2020)

Finalizare
17:45 (29/04/2020)

Confirmare
17:45 (30/04/2020)

Urmatorul interval de timp in:
01 m 08 s
[Reincarca acum](#)

Anunț

In acest examen se verifica diverse actiuni ale studentilor pentru examen

Ora pe server

Toate examenele sunt bazate pe fusul orar al server-ului (ar putea sa fie diferit de timpul local). Pentru referinta ora pe server este acum:

29/04/2020 17:28:51

Fibra optică – Tehnologie

Capitolul 5

Cuprins

- ▶ **Lumina ca undă electromagnetică** (ecuațiile lui Maxwell, ecuația undelor, parametri de propagare)
- ▶ **Elemente de fotometrie și radiometrie** (mărimi energetice/luminoase)
- ▶ **Fibra optică** (realizare, principiu de funcționare, atenuare, dispersie, banda de frecvență)
- ▶ **Cabluri optice** (tehnologie, conectori, lipire – splice)
- ▶ **Proiectare sistemică a legăturii pe fibra optică** (bandă de frecvență, balanța puterilor)
- ▶ **Emițătoare optice** (LED și dioda laser – realizare fizică și funcționare)
- ▶ **Receptoare optice** (dioda PIN, dioda cu avalanșă – realizare fizică și funcționare)
- ▶ **Amplificatoare transimpedanță** (parametri, scheme tipice, TIA în buclă deschisă, cu reacție, diferențiale, control automat al câștigului)
- ▶ **Realizarea circuitelor pentru controlul emițătoarelor optice** (parametri, scheme tipice, controlul puterii, multiplexoare)
- ▶ **Dispozitive de captare a energiei solare** (principiu de funcționare, utilizare, proiectare)

Stabilized light source

Optical power meter

► Masurarea puterii si atenuarii

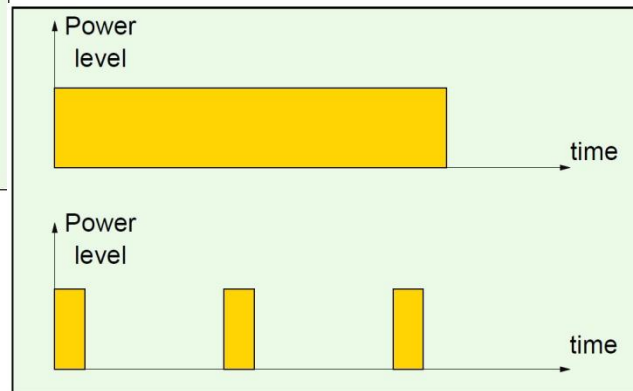
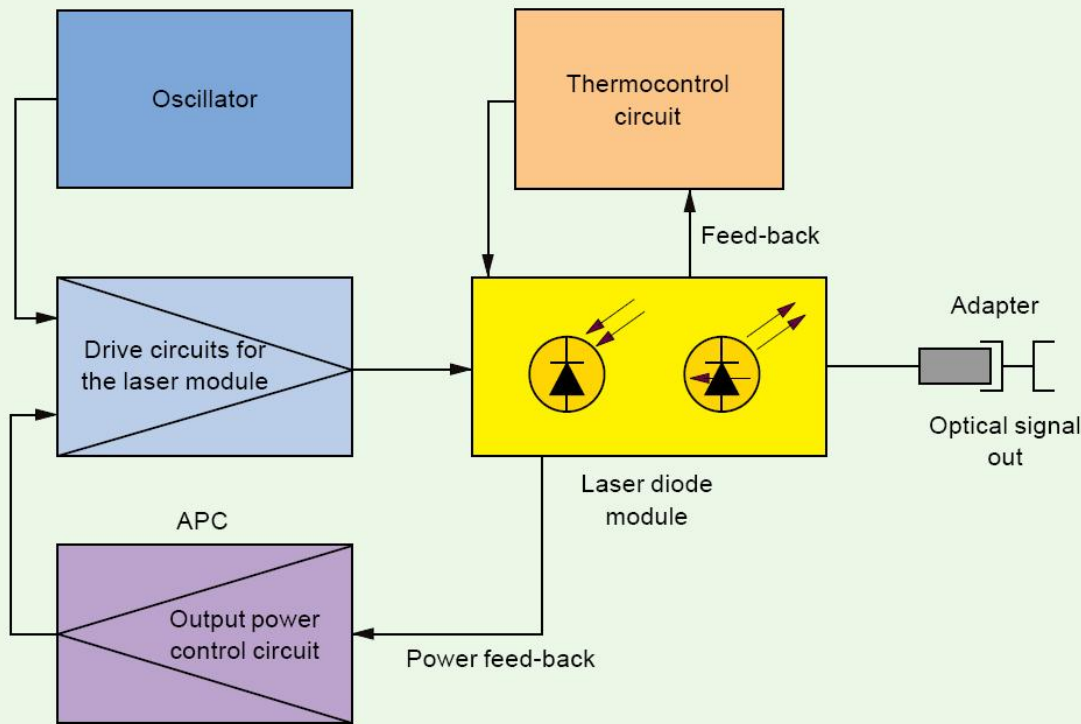

Masurarea puterii si atenuarii

► Masuratoare referinta

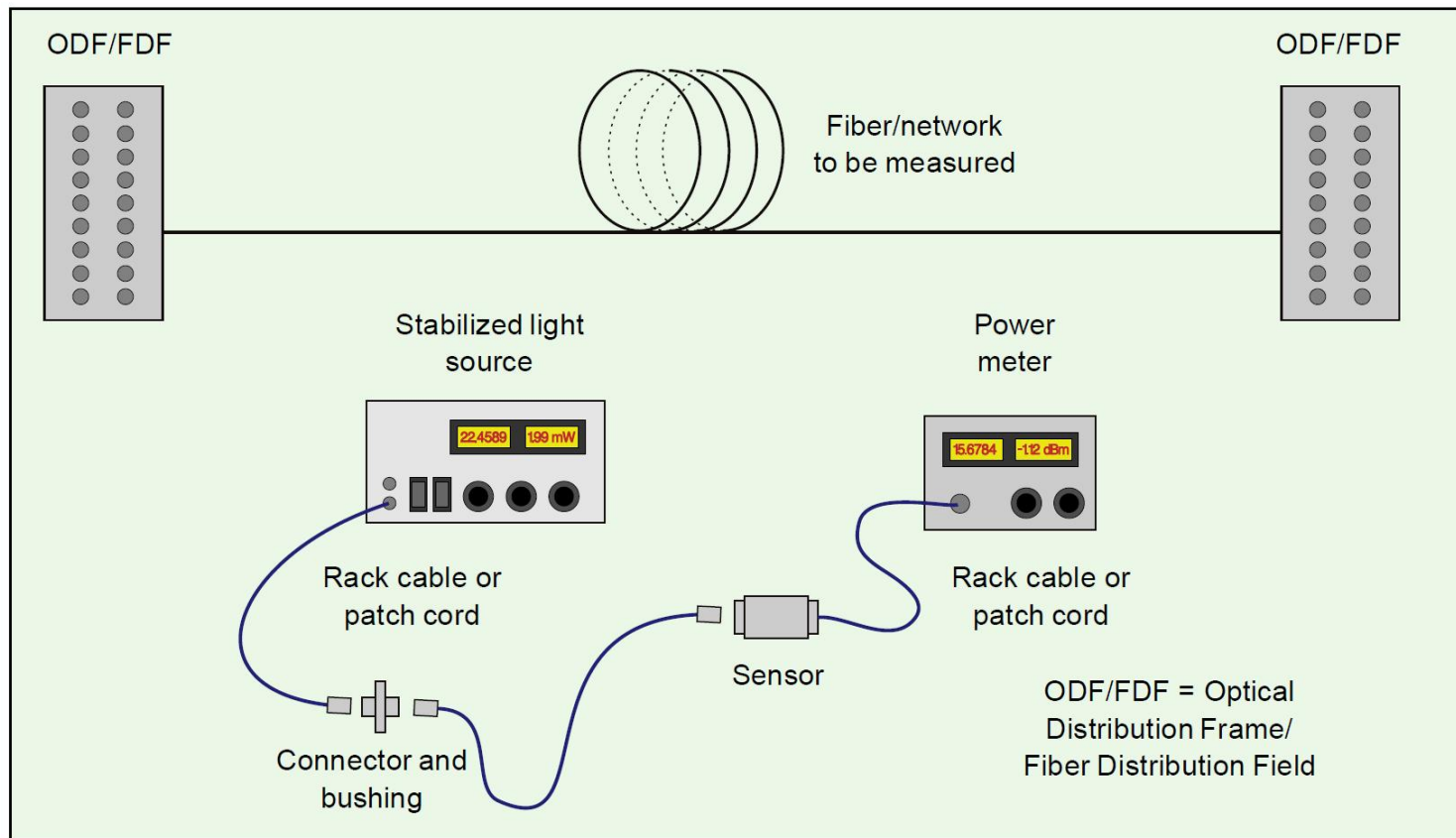

Masurarea puterii si atenuarii

► Masuratoare instalatie

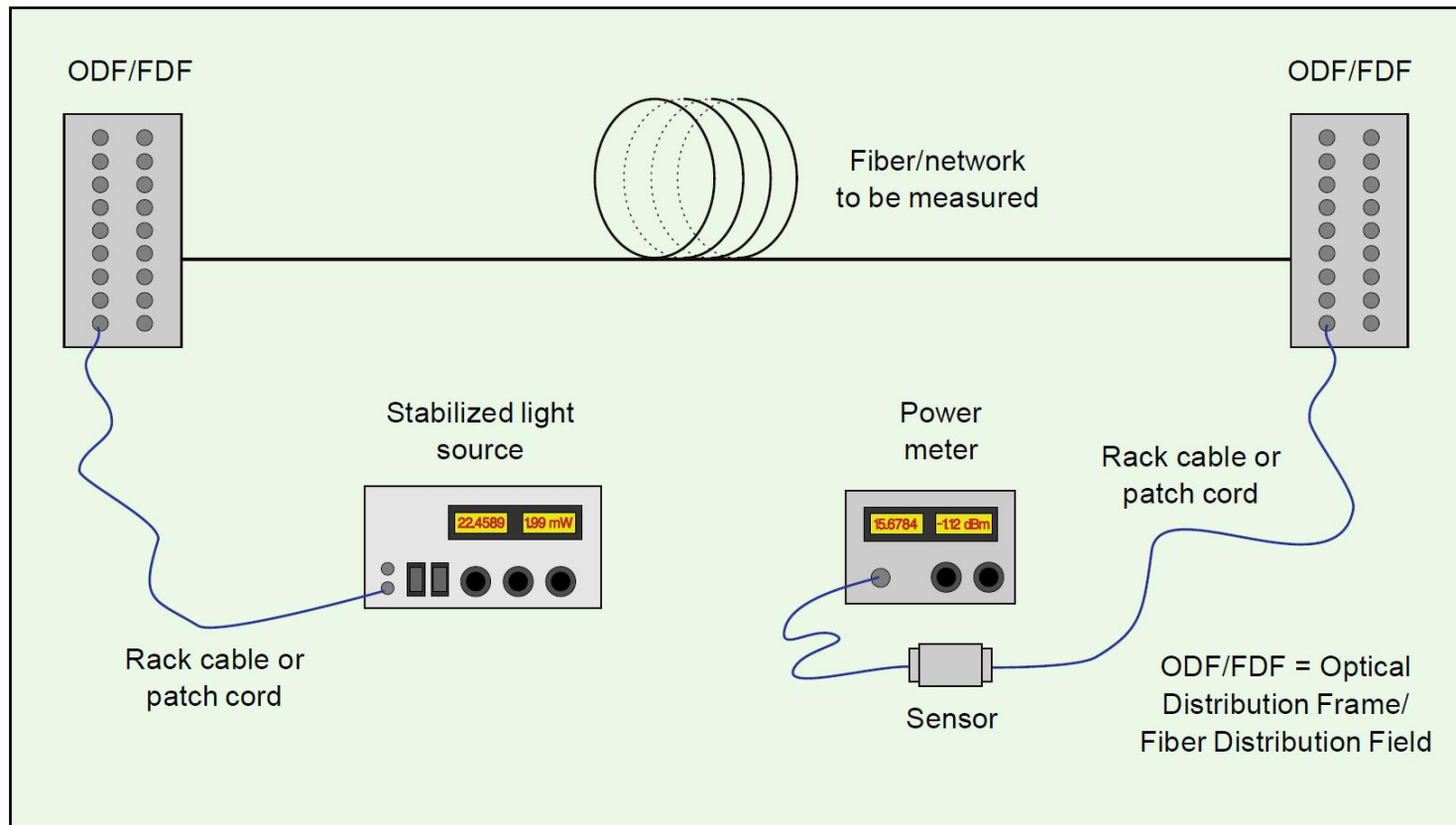

Masurare conectori si splice

- ▶ Se elimina efectele fibrei

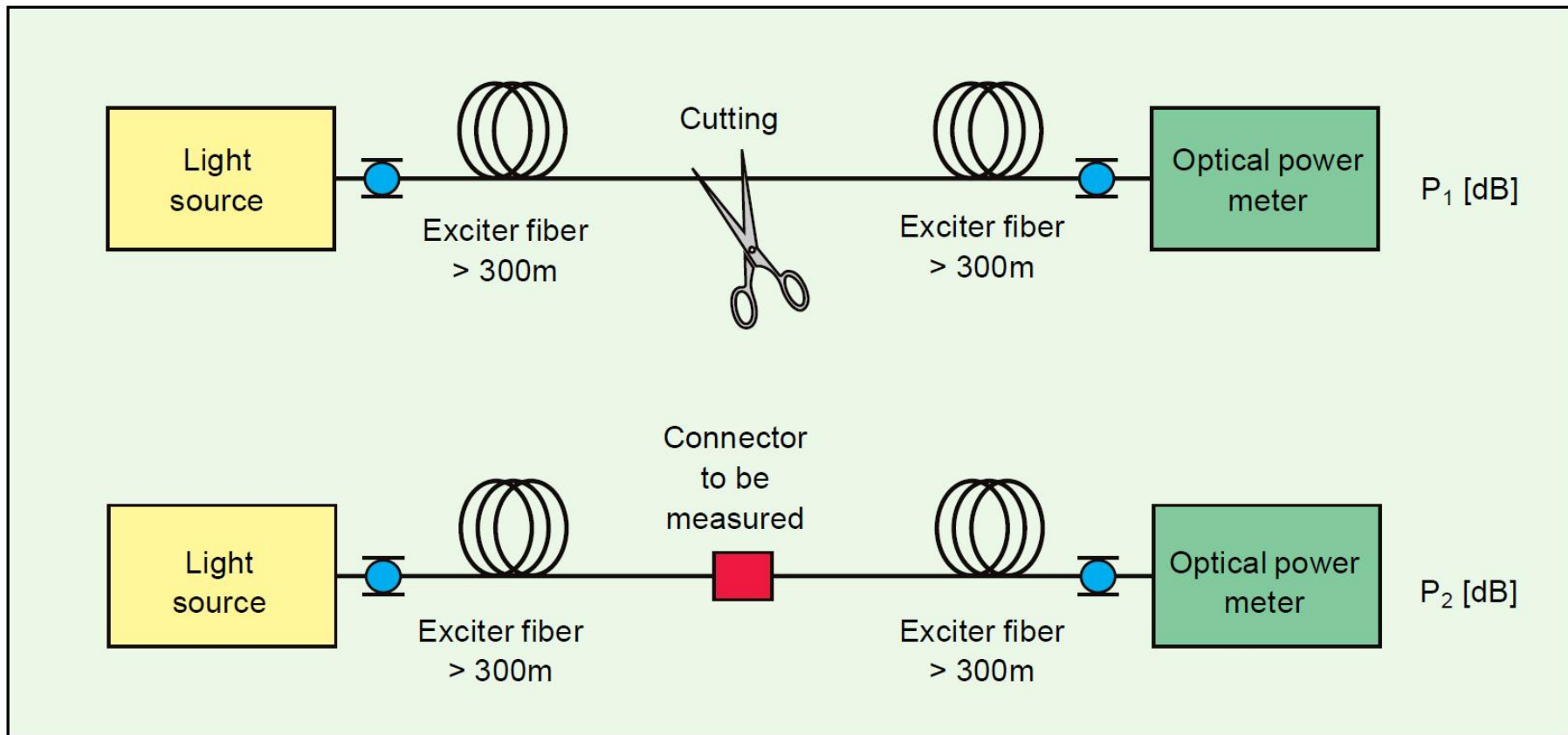

OTDR

- ▶ Optical Time-Domain Reflectometer
- ▶ Localizarea defectelor

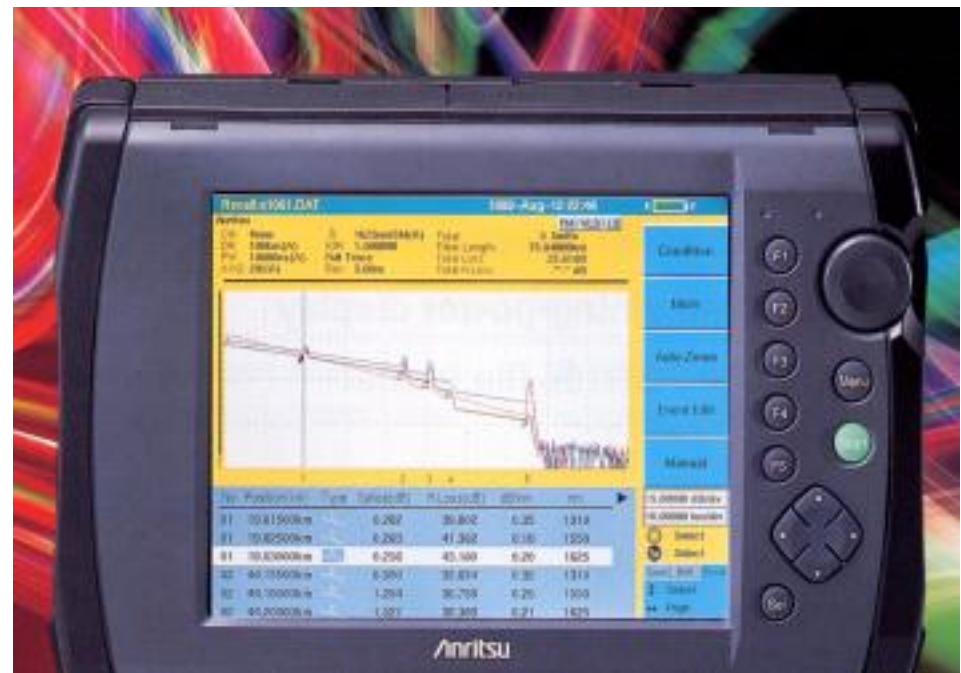
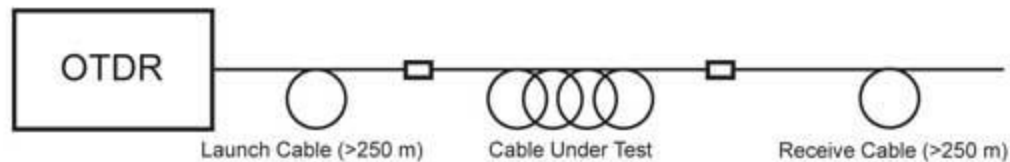

OTDR

- ▶ Optical time-domain reflectometer
- ▶ Localizarea defectelor

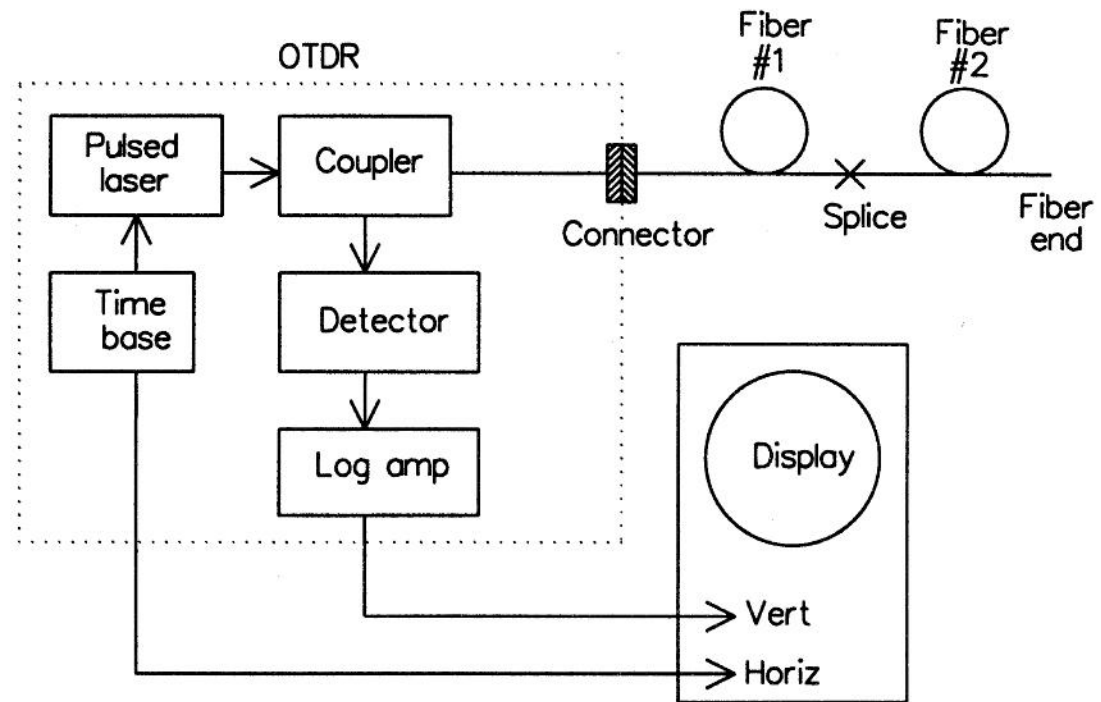

Rezultat grafic al OTDR

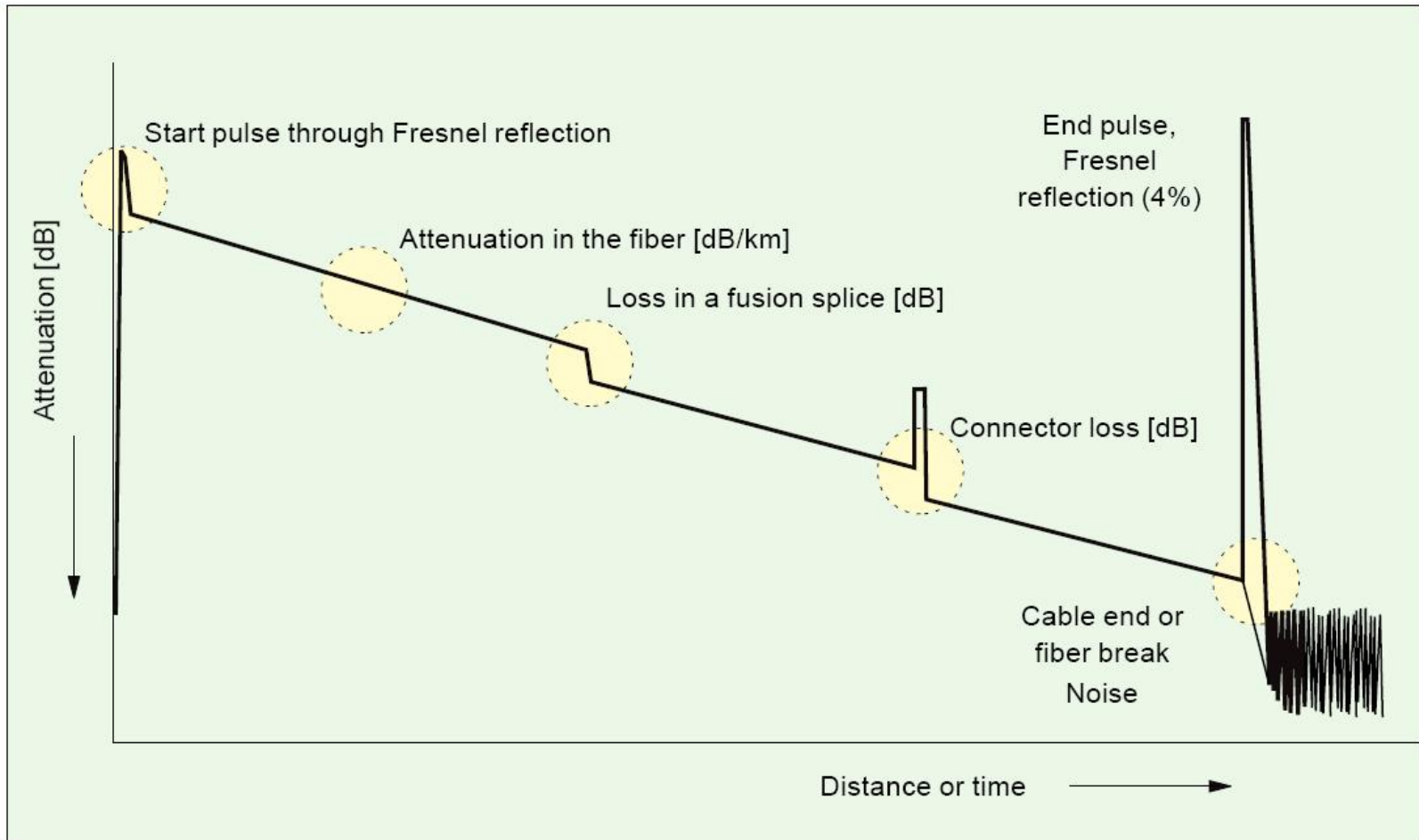

Efecte vizibile OTDR

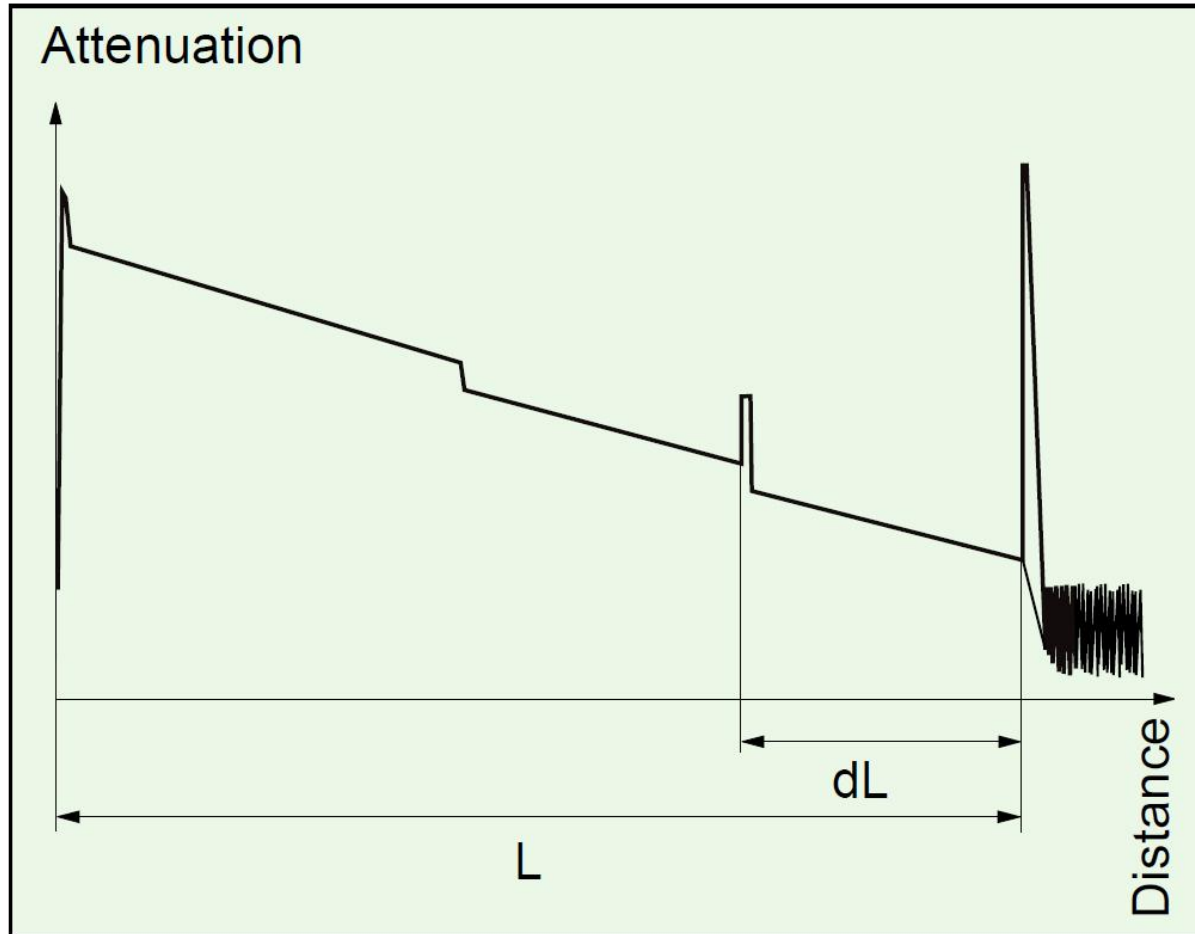

$$2 \cdot L = c \cdot t$$

$$L = \frac{c_0}{n} \cdot \frac{t}{2}$$

Efecte vizibile OTDR

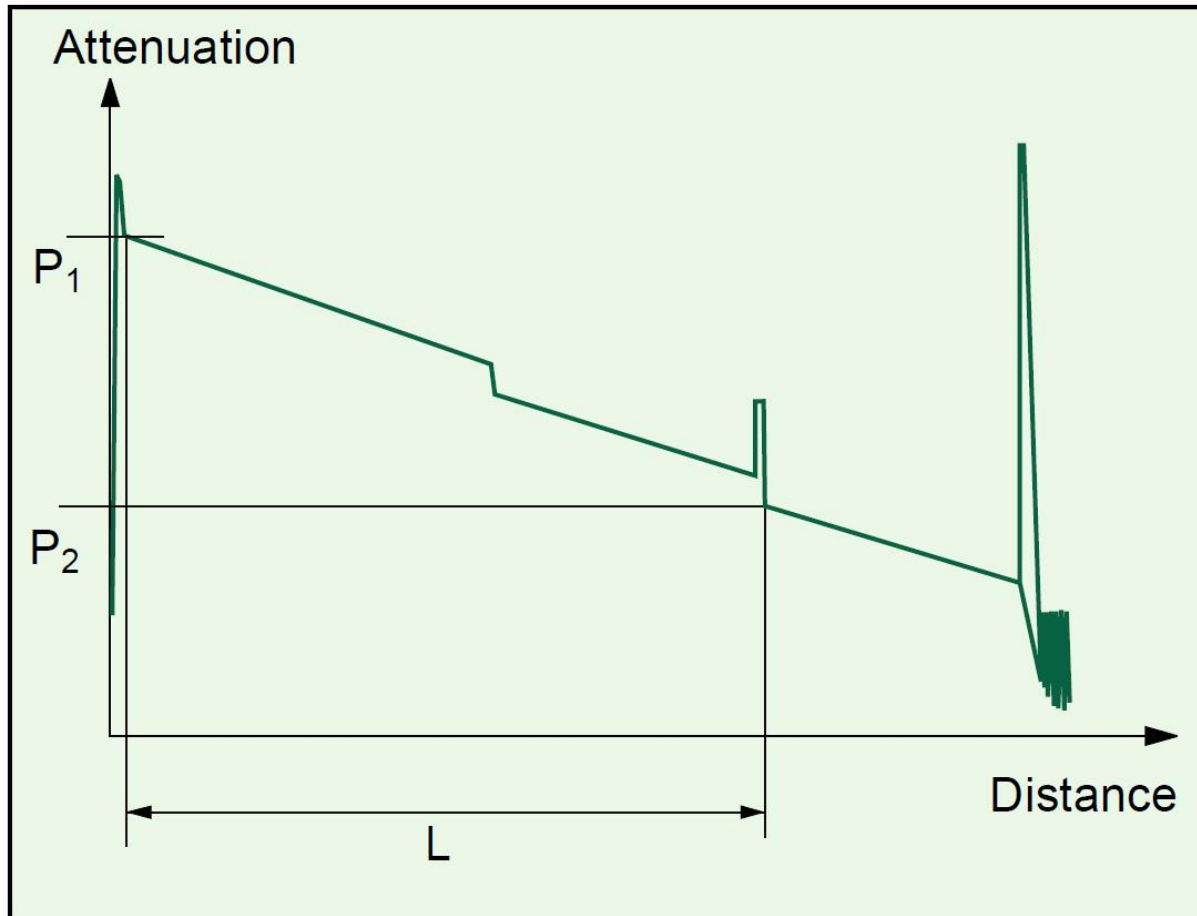

$$A[dB] = \frac{P_1 - P_2}{2}$$

$$A[dB/km] = \frac{P_1 - P_2}{2 \cdot L}$$

panta curbei

Efecte vizibile OTDR - Splice

- ▶ splice loss - $A(s)$

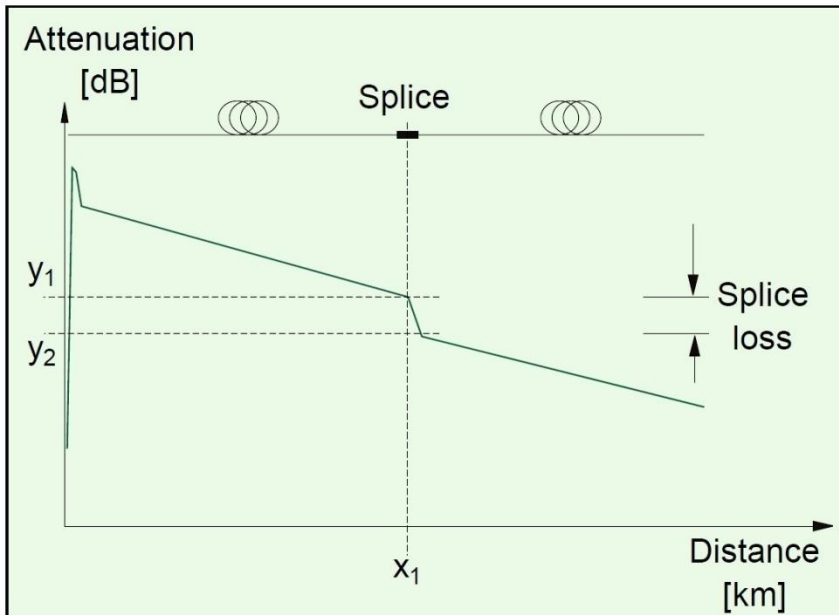

$$A(s) = y_1 - y_2$$

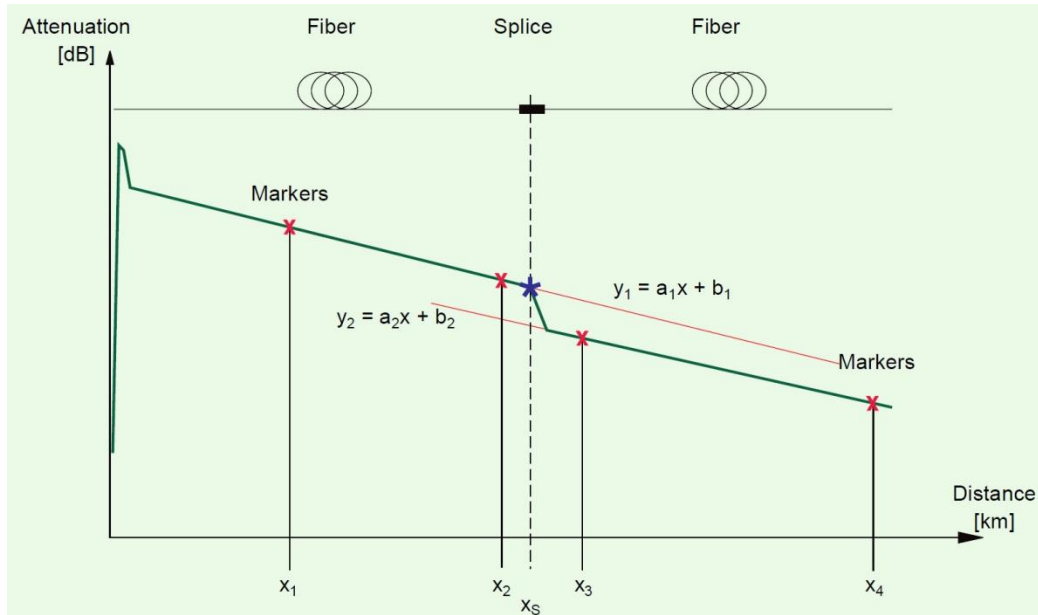

$$A(s) = y_1 - y_2 = x_s \cdot (a_1 - a_2) + (b_1 - b_2)$$

Efecte vizibile OTDR – Splice

a. same fiber spliced

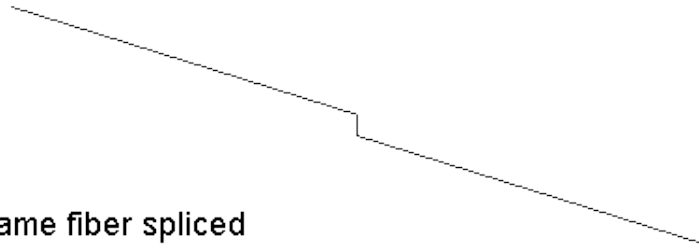

error caused by fiber characteristics

actual loss

b. high loss fiber spliced to low loss fiber

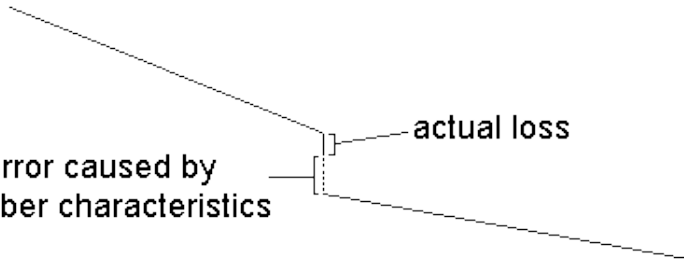

error caused by fiber characteristics

actual loss

error caused by fiber characteristics

actual loss

c. low loss fiber spliced to high loss fiber can cause an apparent gain at a splice

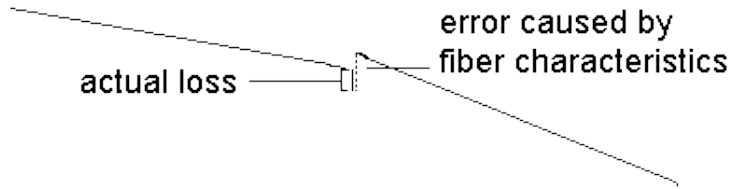

$$A(s) = \frac{A(s)_{A \rightarrow B} + A(s)_{B \rightarrow A}}{2}$$

Rezultat grafic al OTDR

► latimea pulsurilor luminoase

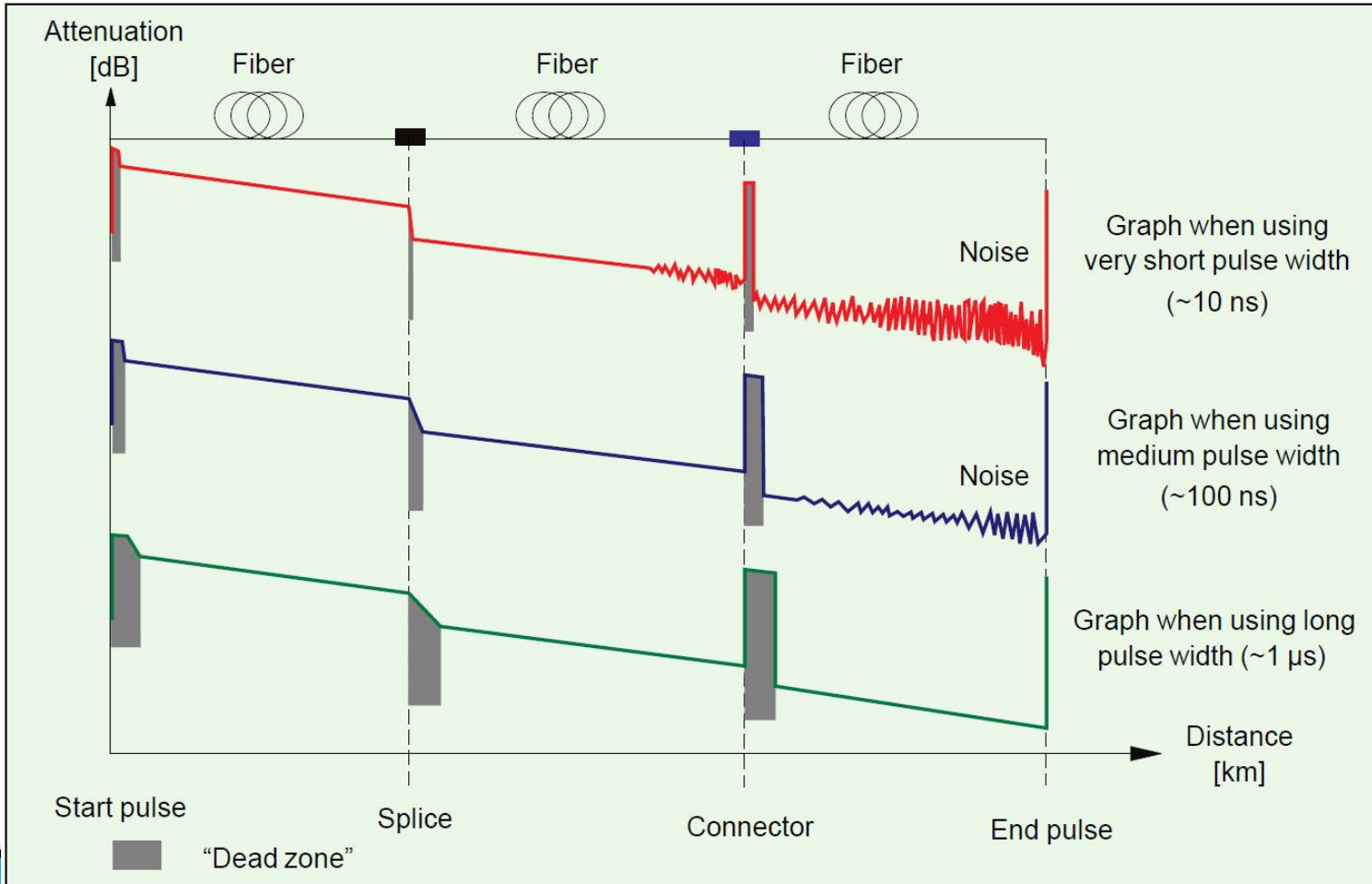

OTDR

Typical OTDR Trace

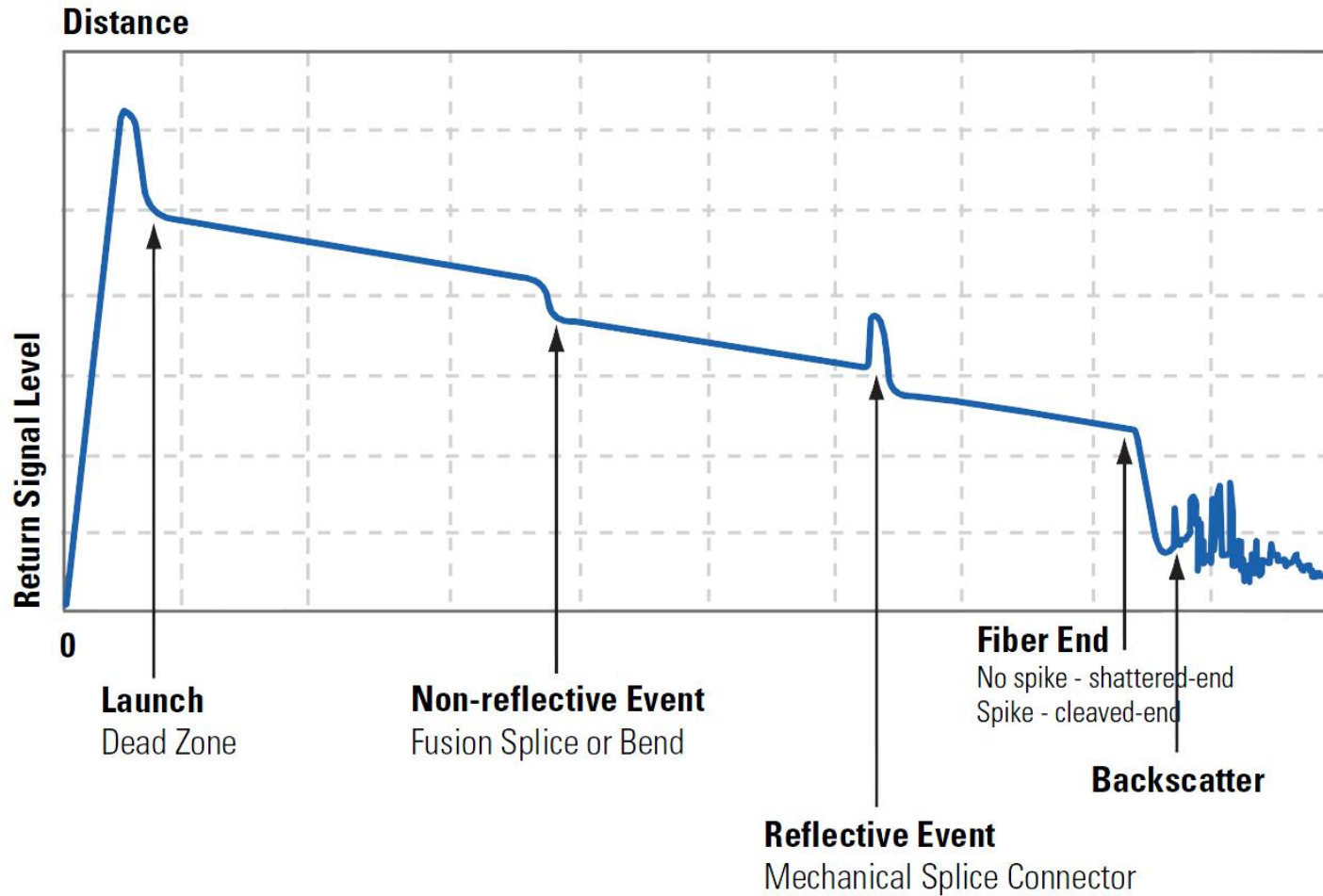

Taiere – Cleaving

- ▶ Tehnici necesare pentru a asigura o taiere perpendiculara pe axa fibrei

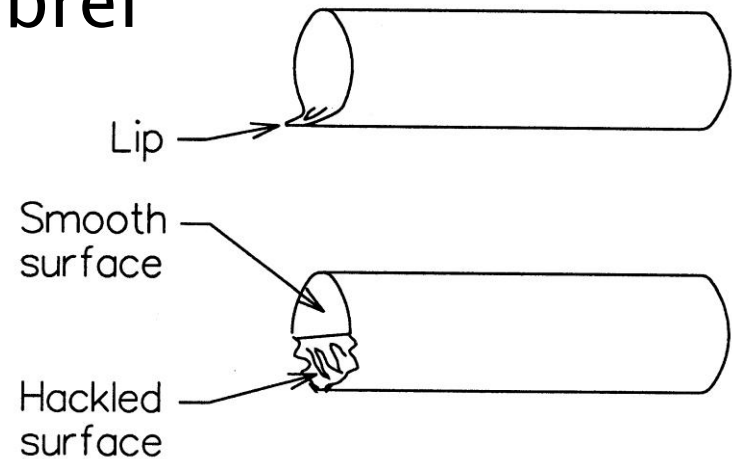
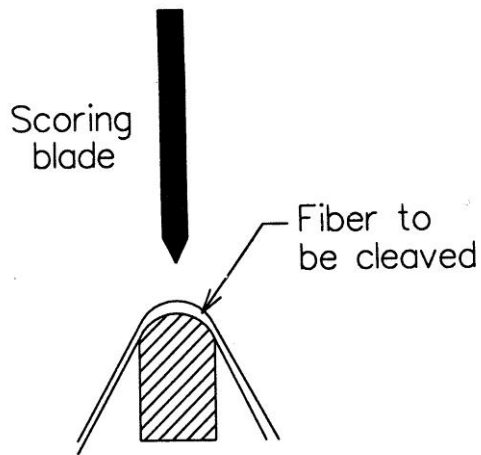

Lipire prin fuziune



Splice prin fuziune

Fibers Stripped of Coating, Cleaned, and Cleaved, are Brought Together During the Fusion Arc

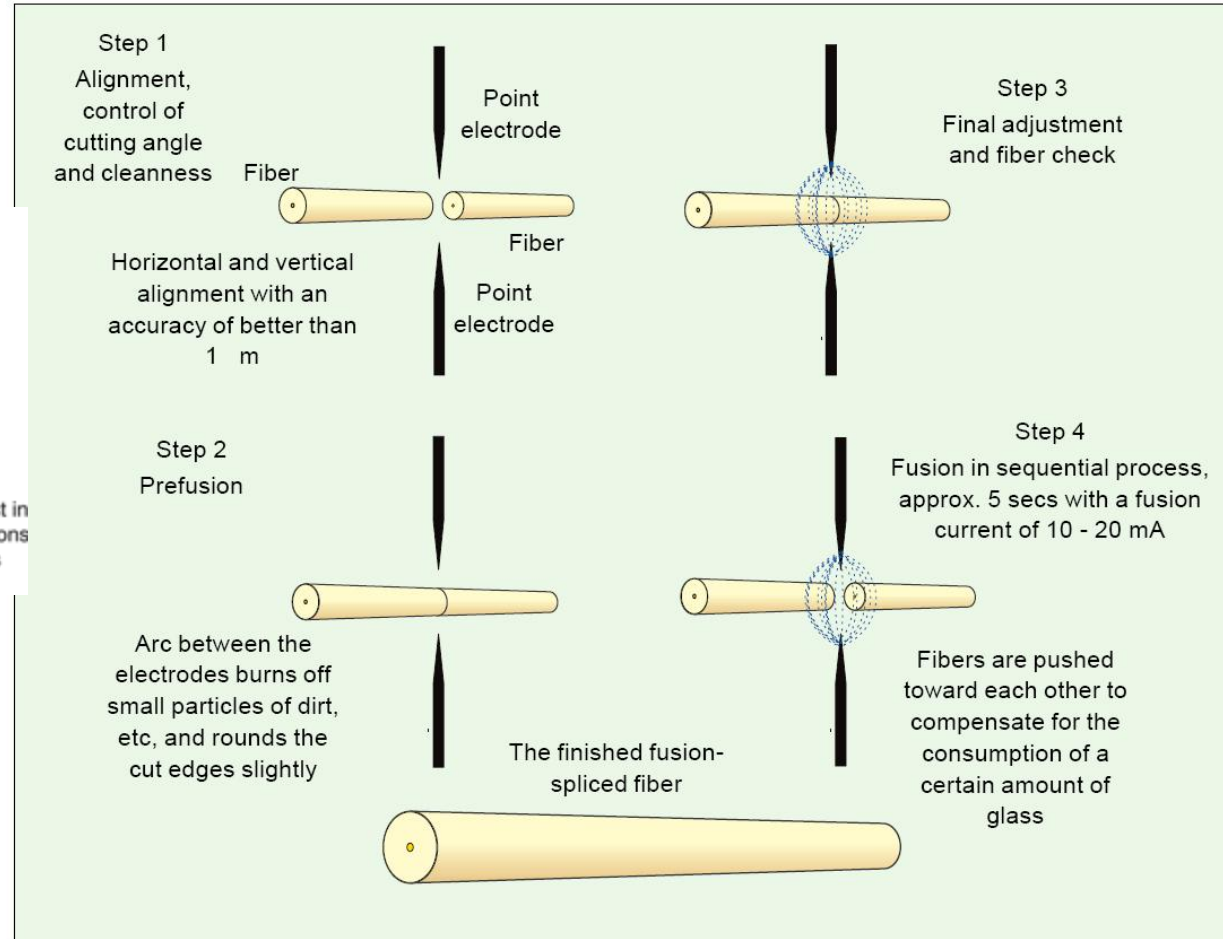
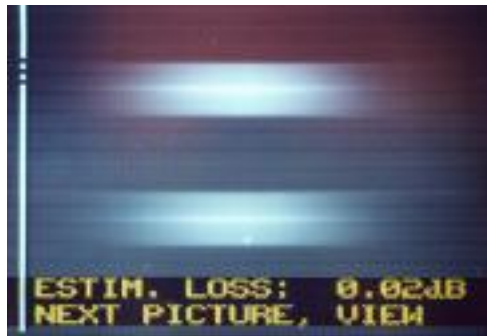
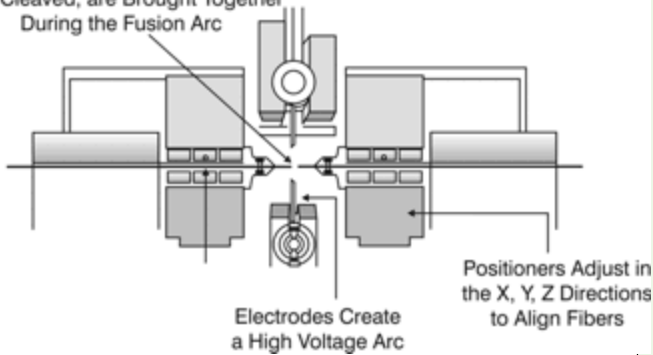

Splice prin fuziune

Causes of faults in fiber fusion

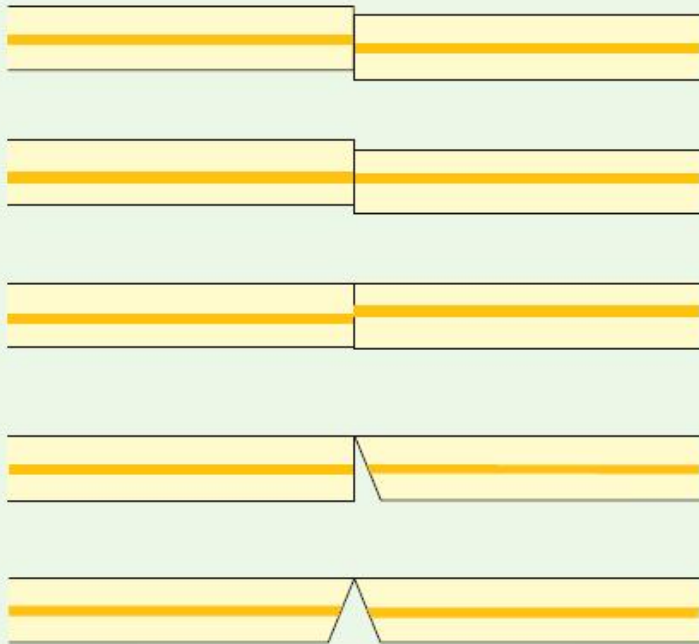

Appearance after fusion

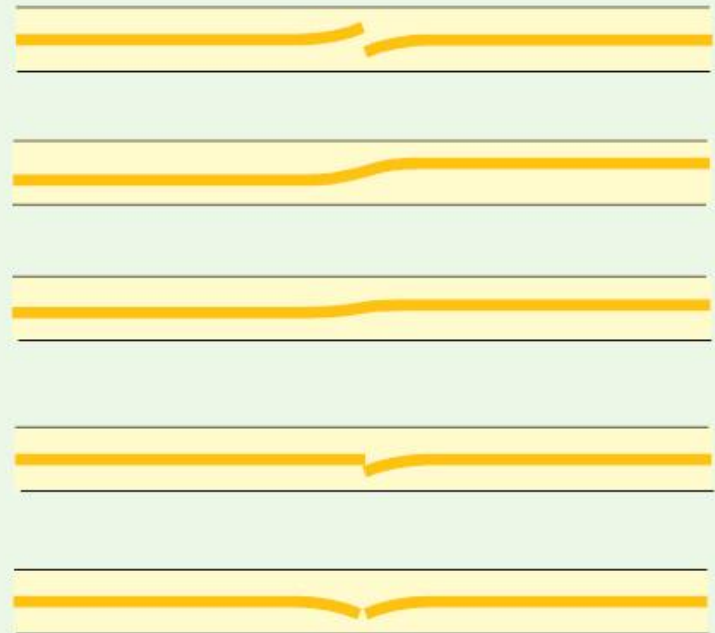

Splice mechanic – bloc V

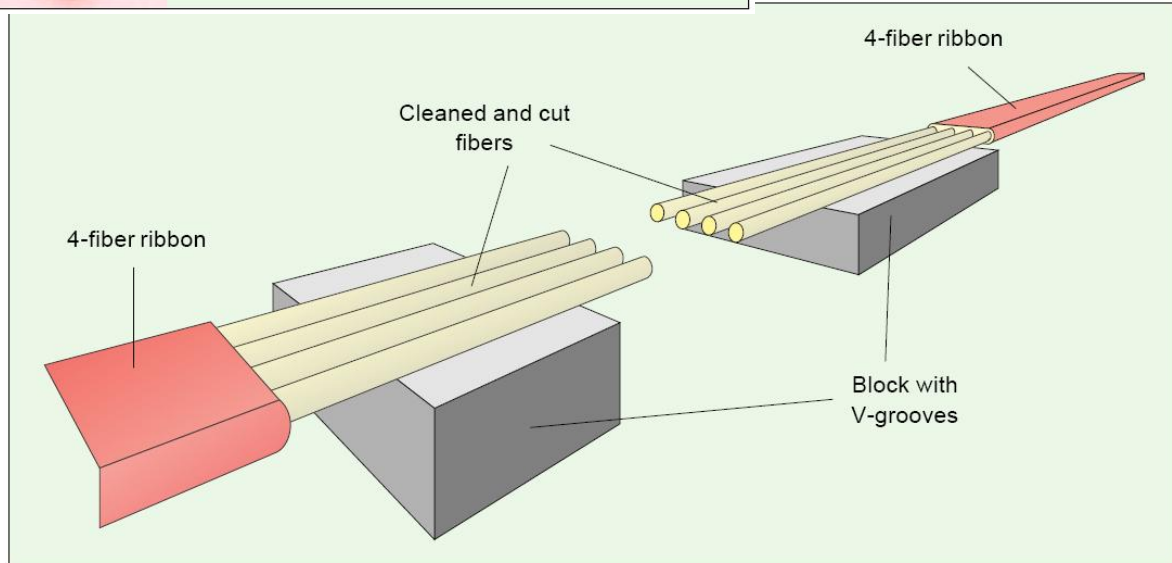
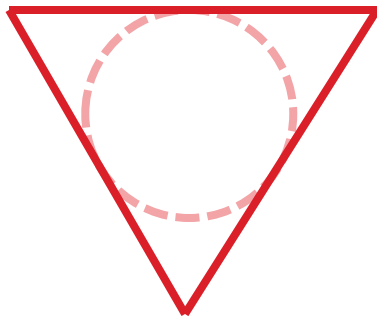
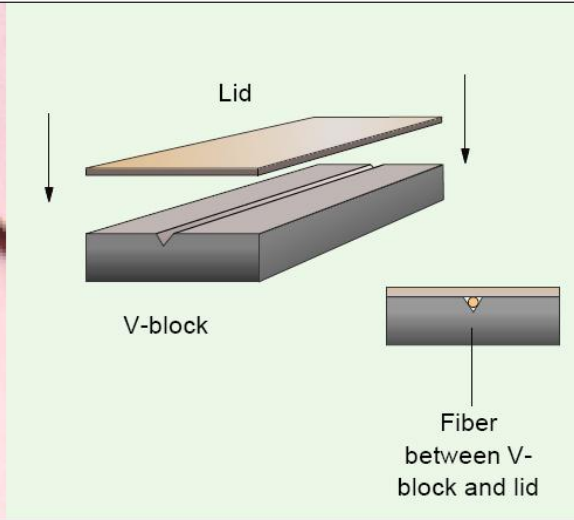
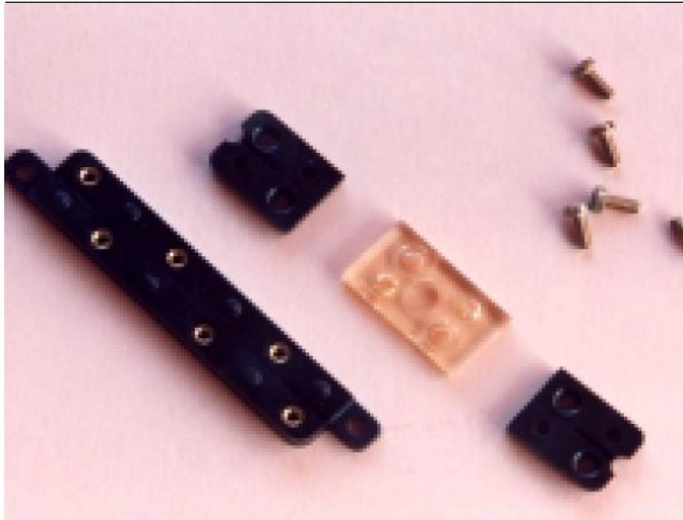

Splice mechanic - bloc V

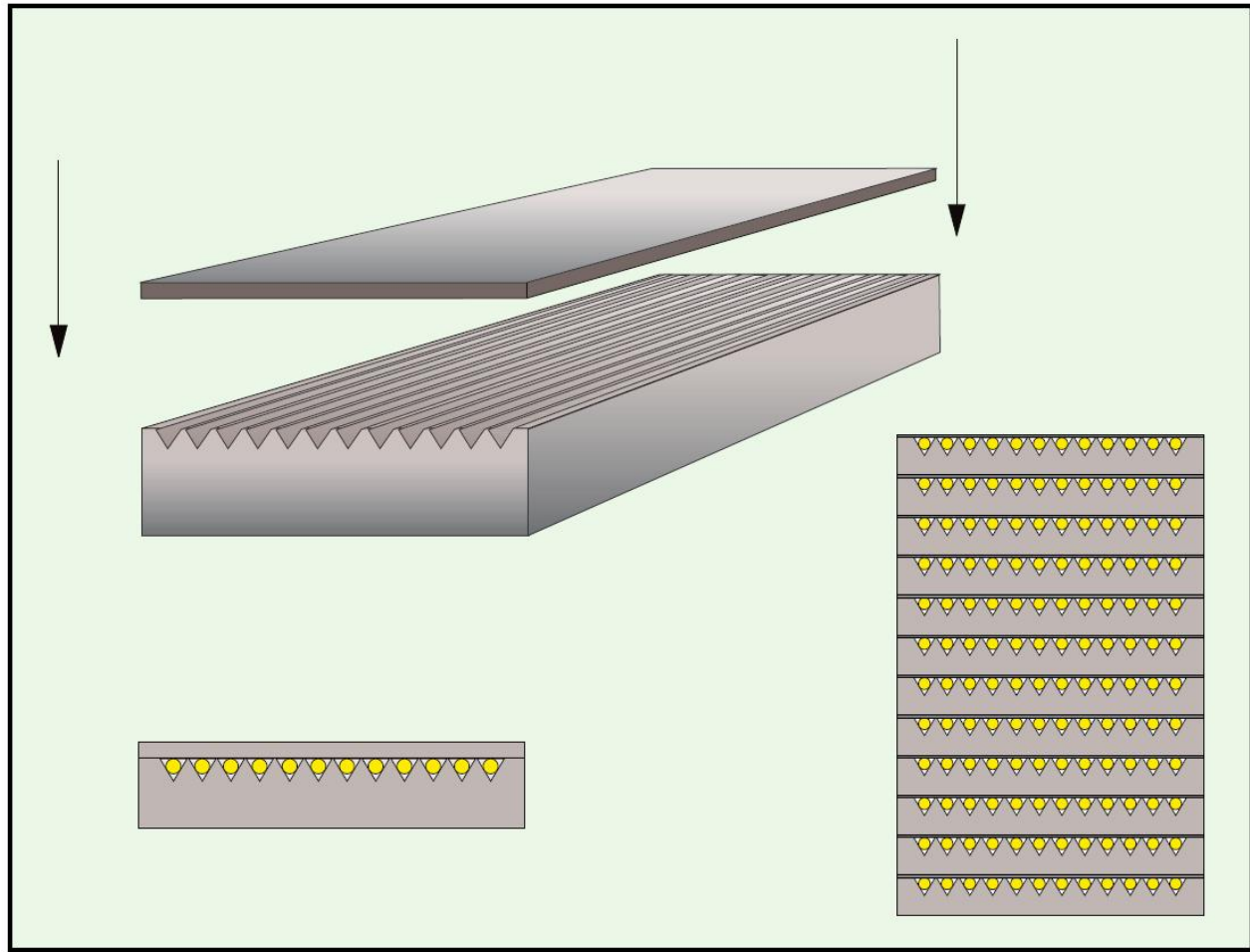

Splice mechanic

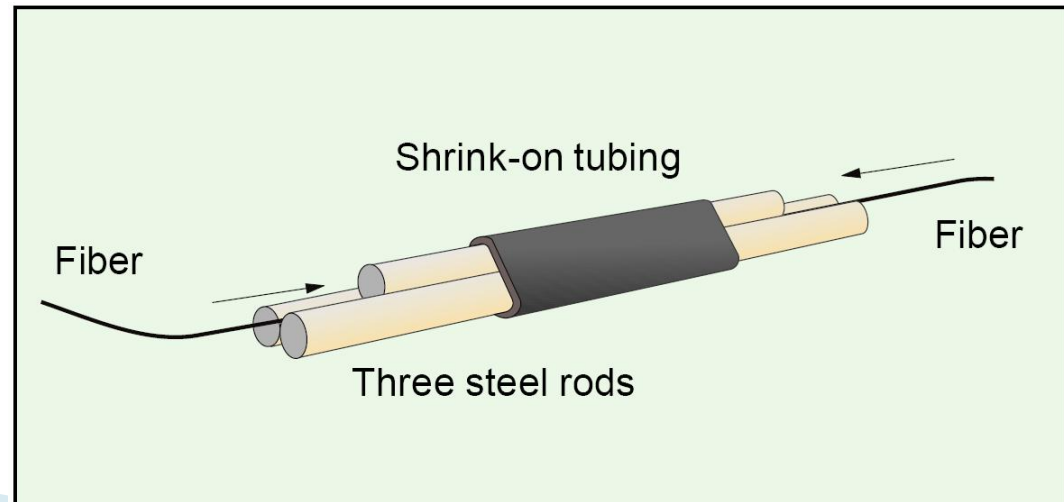
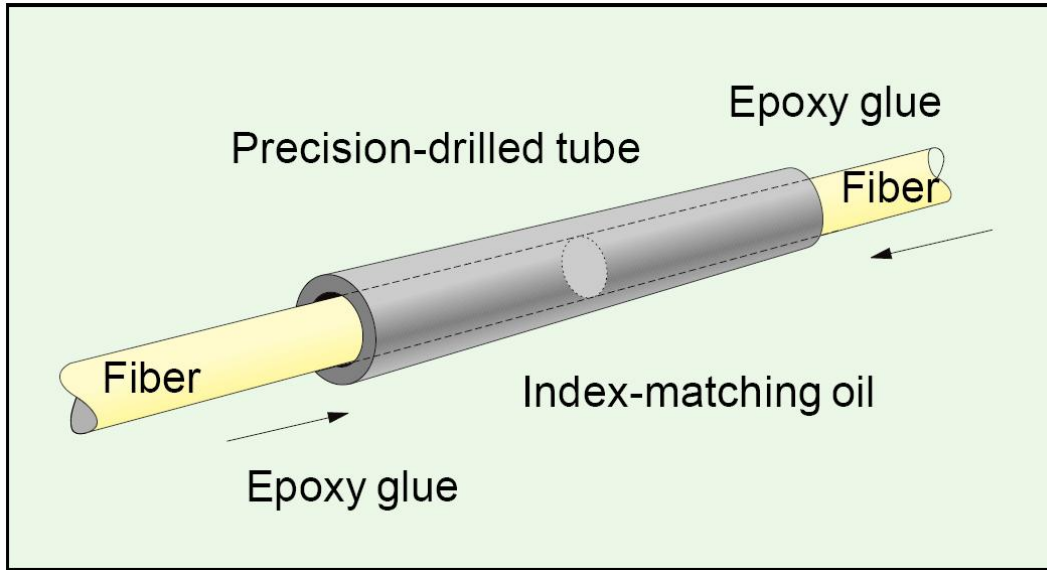

Probleme Fibre/Conectori

Offset

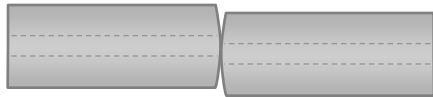

Angular Misalignment

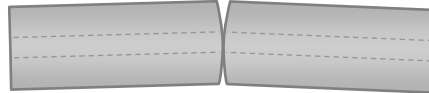

Separation



Core Eccentricity

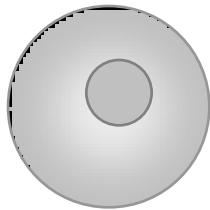

Core Ellipticity

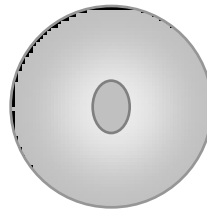

Reflections & Interference

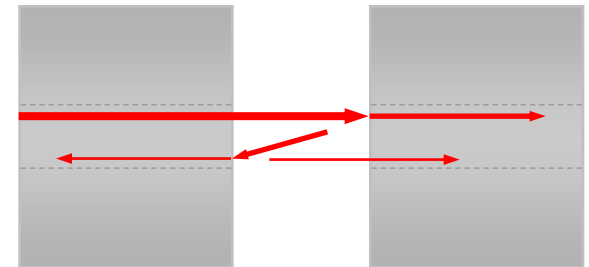

Cabluri

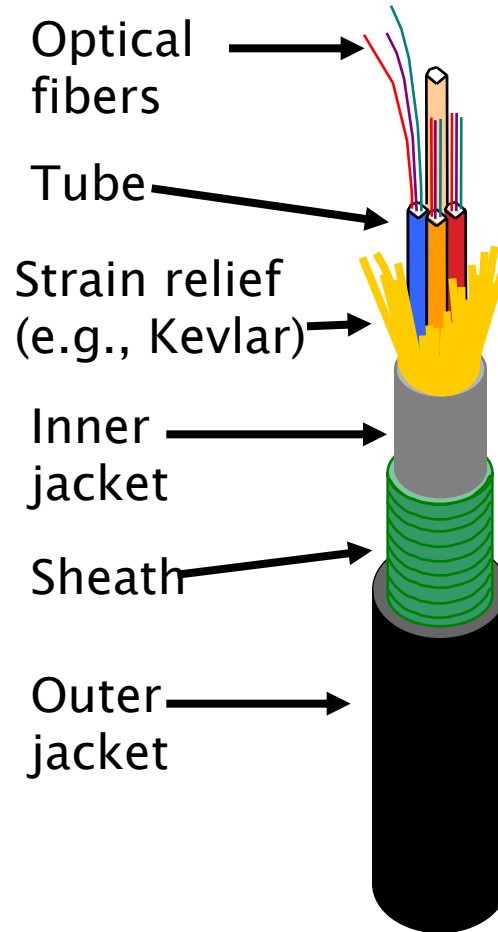
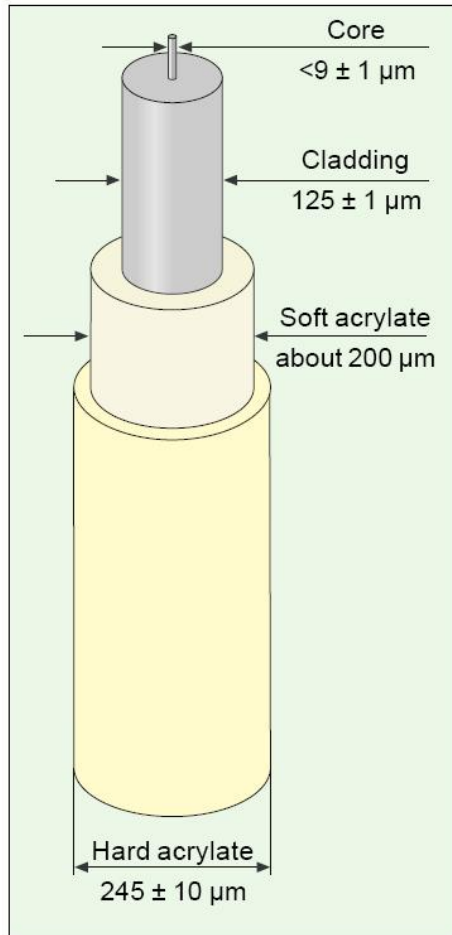

Cabluri

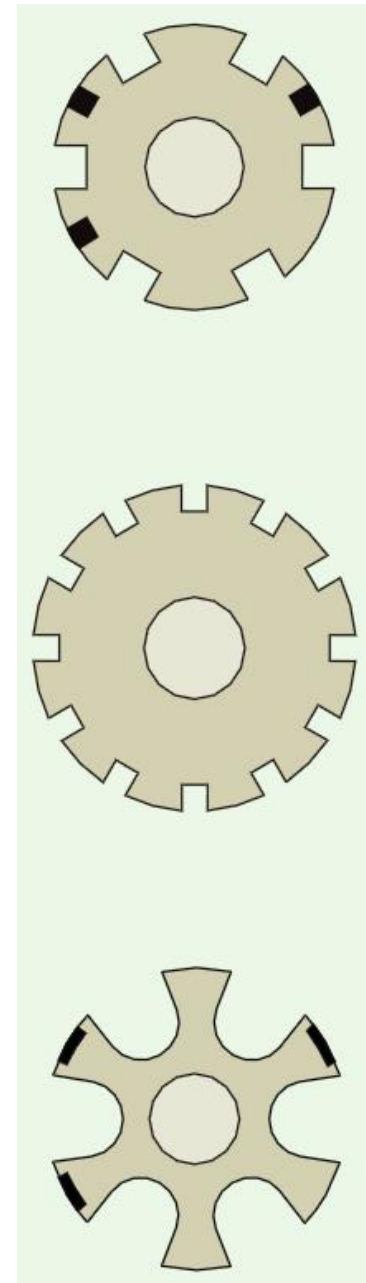
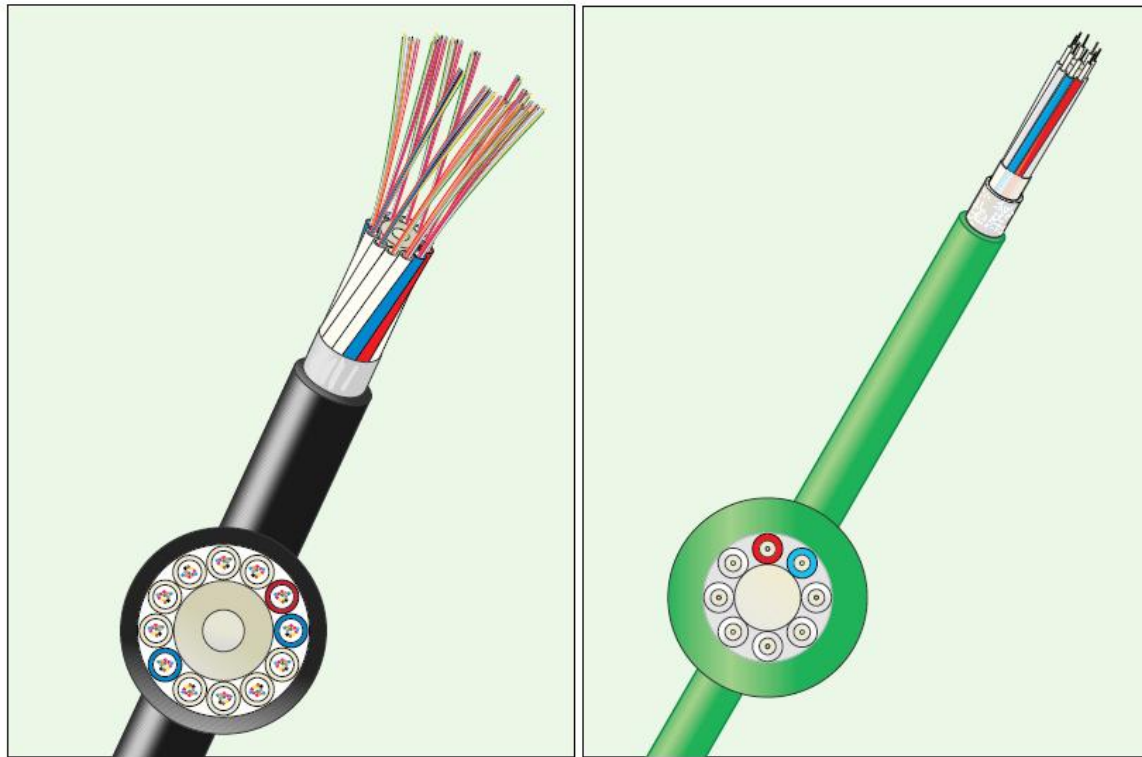

Cabluri

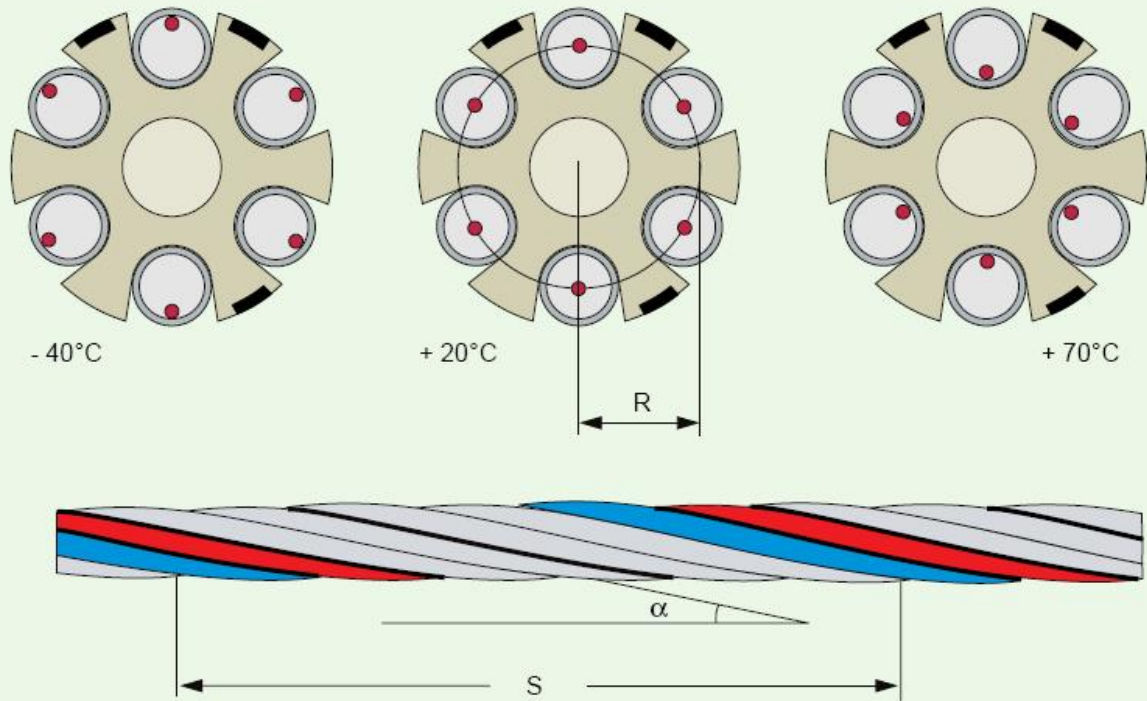

$$S' = S \cdot \sqrt{1 + \left(\frac{2\pi \cdot R}{S} \right)^2}$$

$$\frac{\Delta L}{L_0} = \sqrt{1 + \left(\frac{2\pi \cdot R}{S} \right)^2} - 1$$

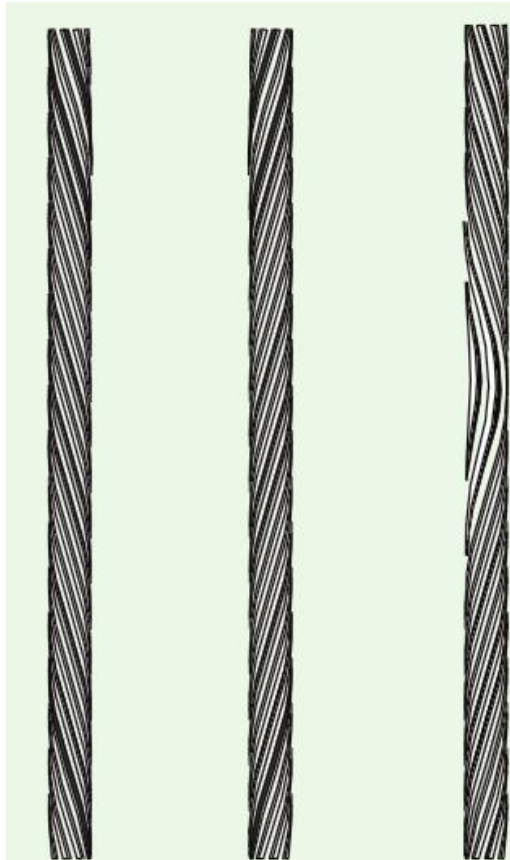

Cabluri

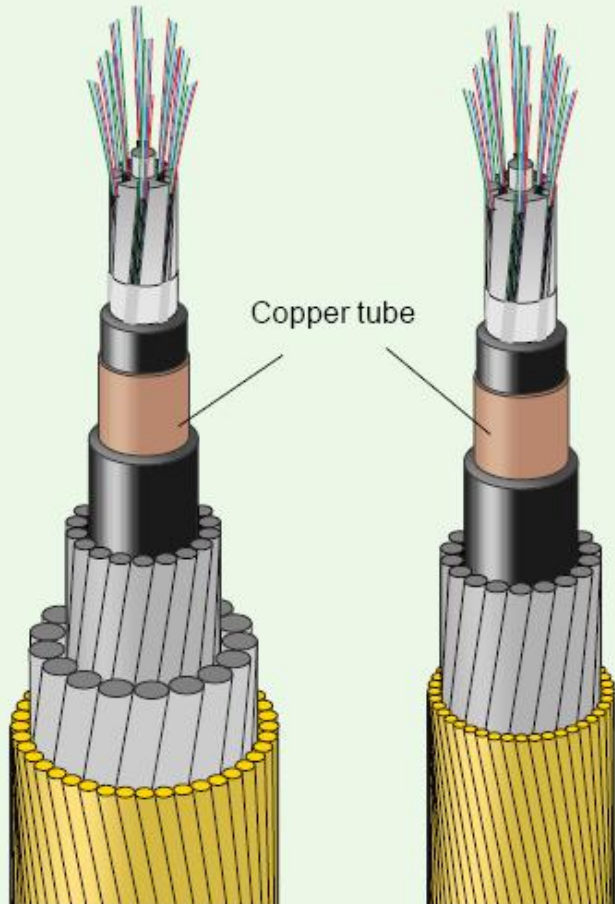
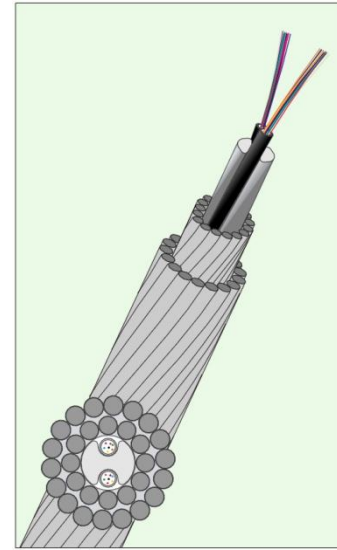

Primary coated fiber

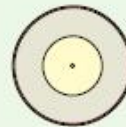

12-fiber ribbon



12 × 12-fiber ribbons
= 144 fibers



"Lose tube"

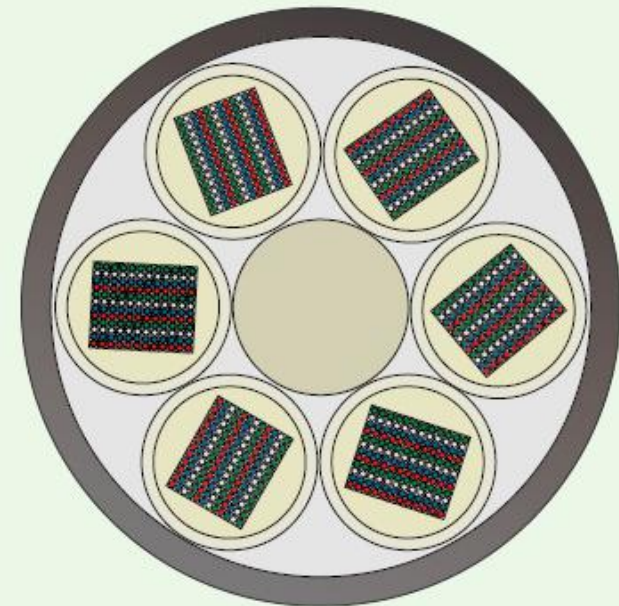

Finished cable with central strength member and with six tubes with each tube containing 144 fibers

Conettori

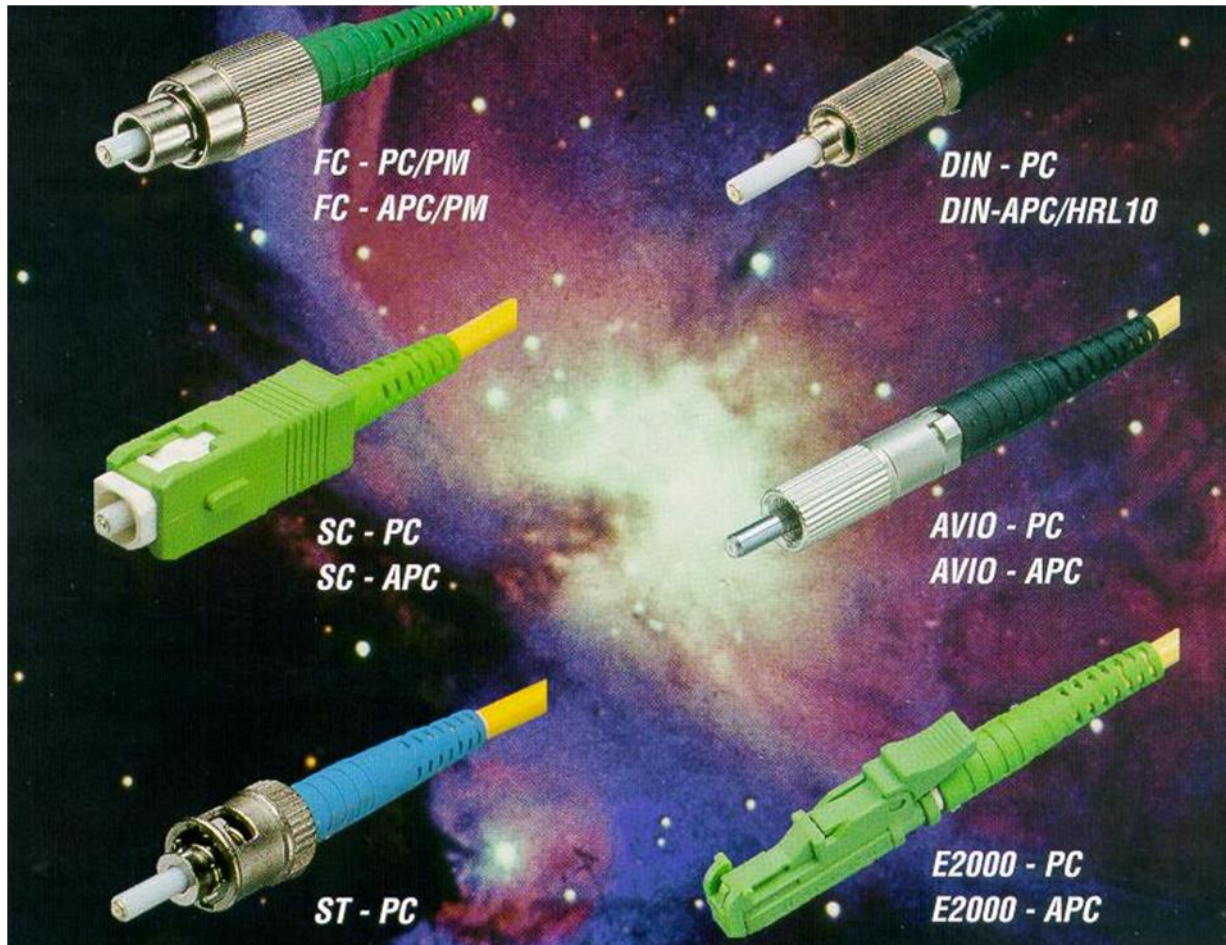

Conettori

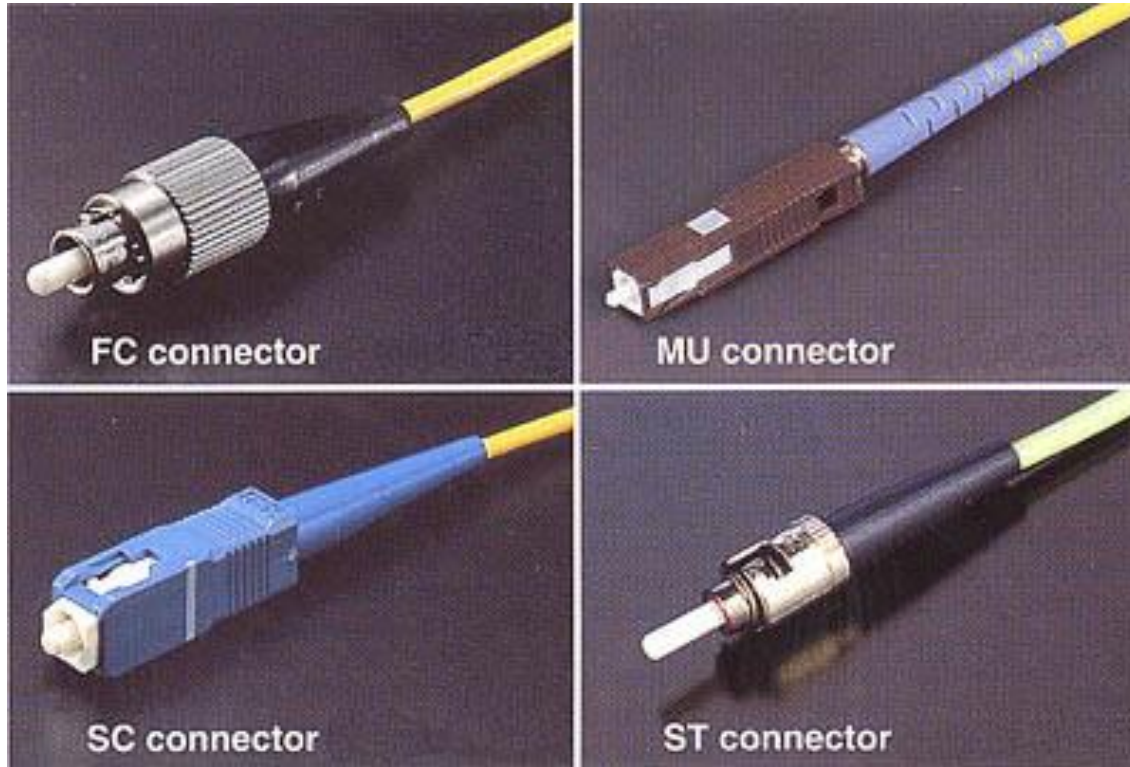

ST

All fiber-optic connectors use ferrules to hold the ends of the fiber and keep them properly aligned.



SMA Type 906

The ST connector uses a half-twist bayonet type of lock, while SMA and FC use threaded connections.



FC

The SC uses a push-pull connector similar to common audio and video plugs and sockets.

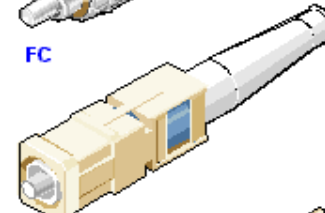

SC

The MIC is the standard FDDI connector.

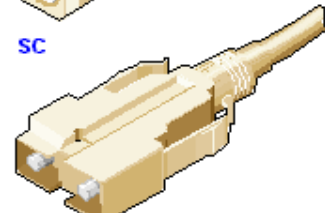

MIC

The Fiber Jack connector attaches two fibers in a snap lock connector similar in size and ease of use as an RJ-45 connector.



Fiber Jack



MT-RJ

MT-RJ is a popular connector for two fibers in a very small form factor.

Conectori

- ▶ Verificati <http://rf-opto.etti.tuiasi.ro>

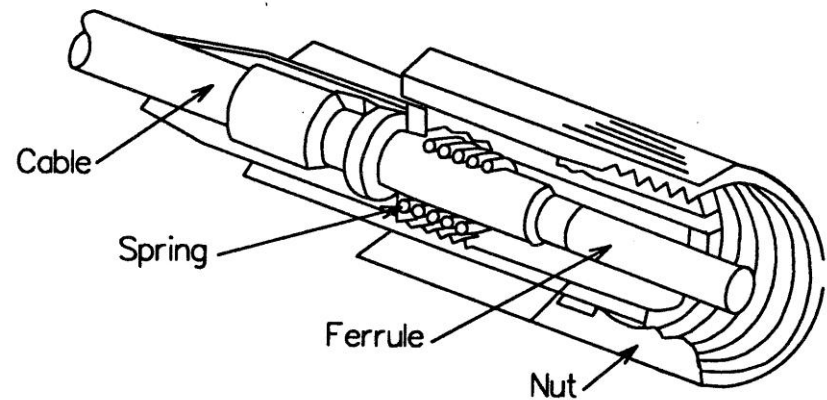
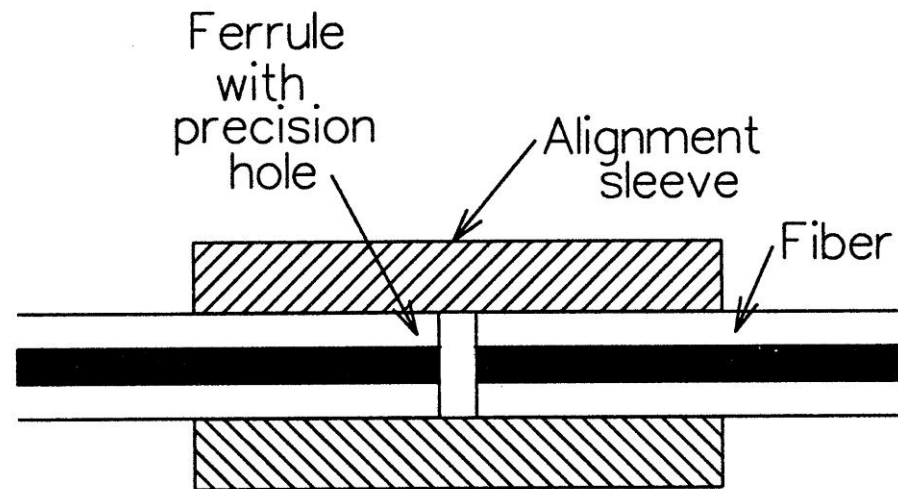
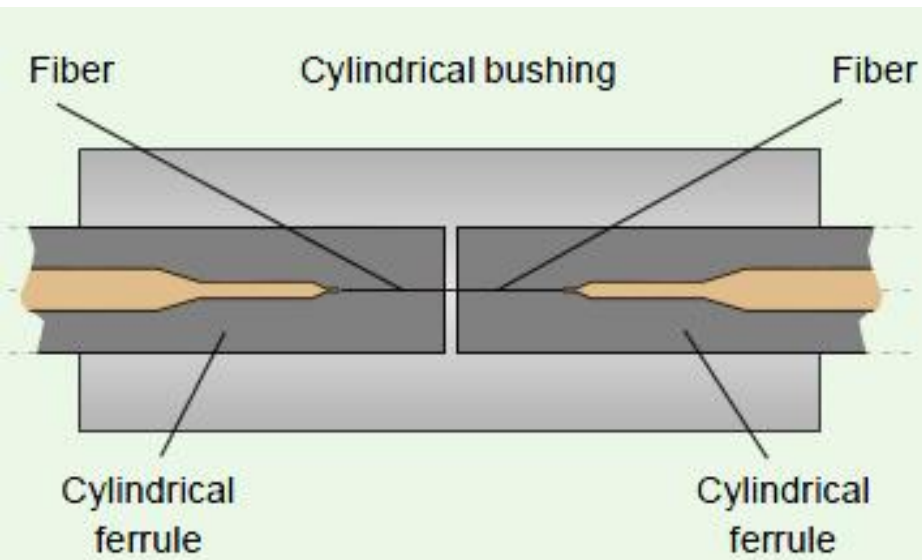

Conettori

▶ Ferula semisferica

- 20mm
- 60mm

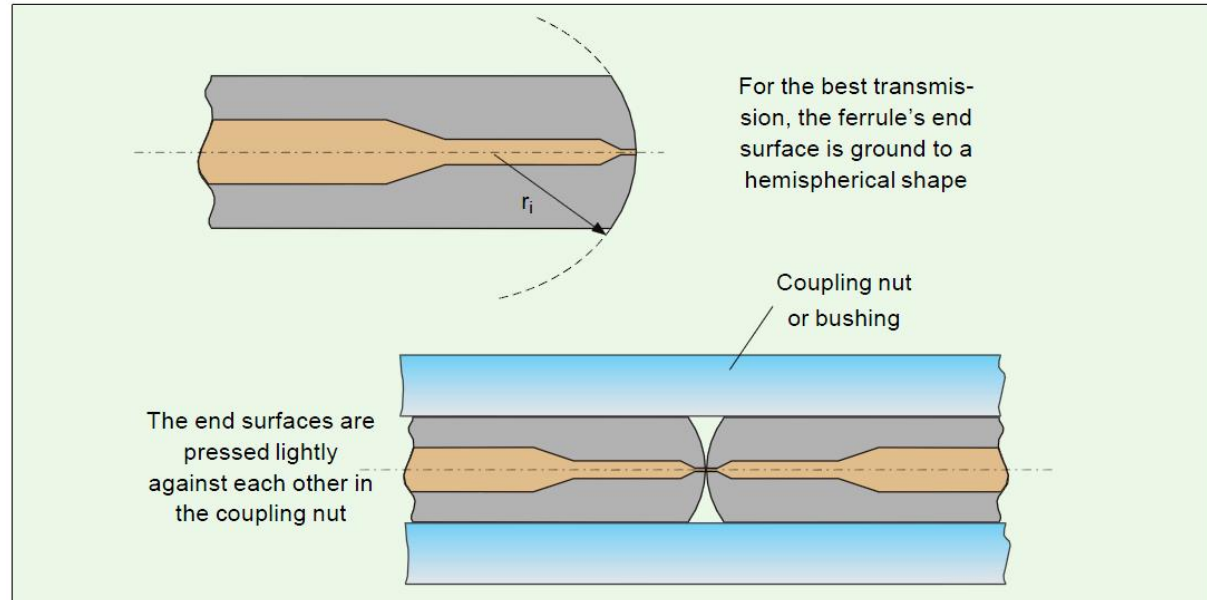

▶ Conettori multifibra

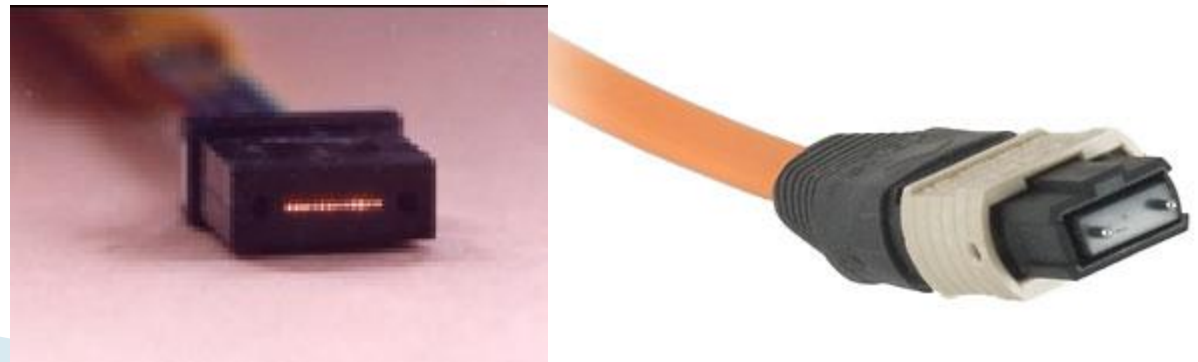

Expanded beam connector

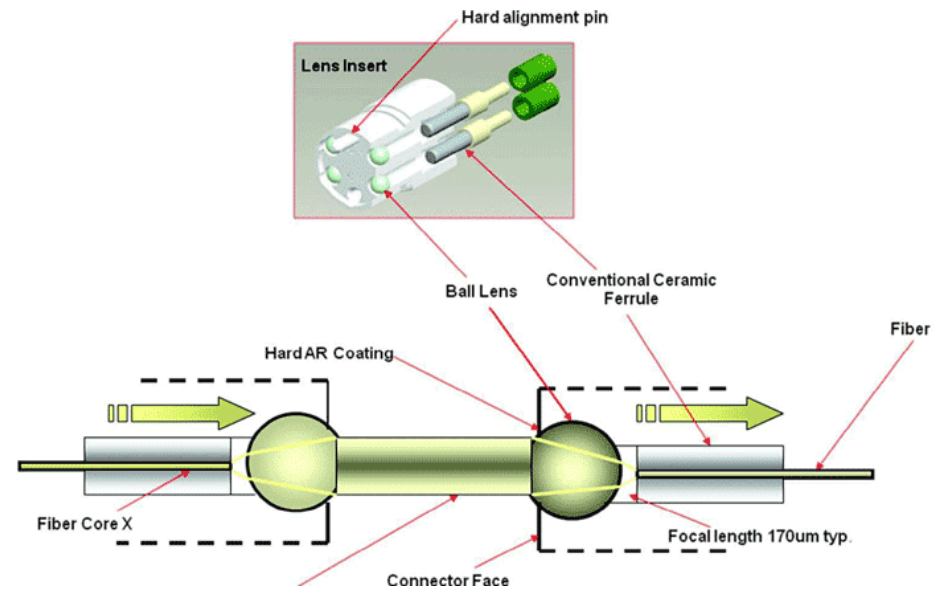
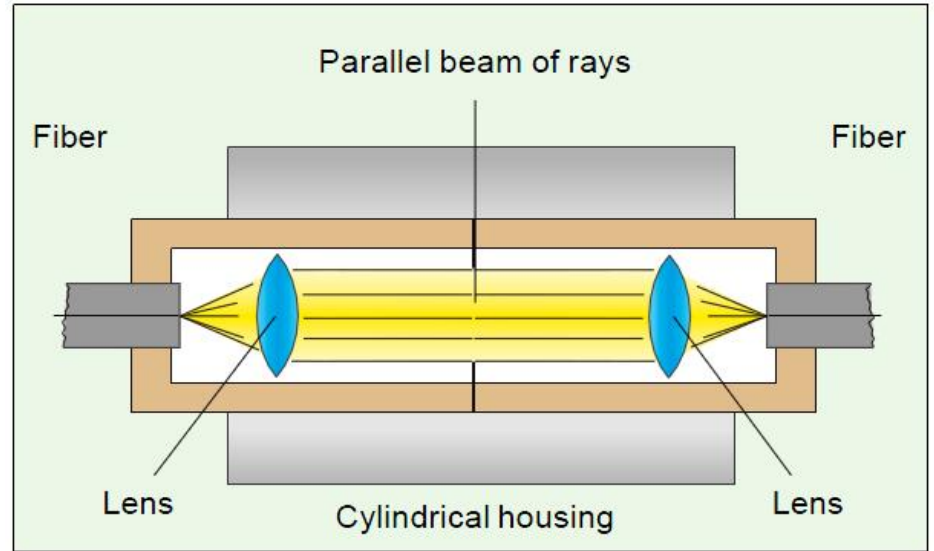

FTTH

- ▶ FTTN: Fiber to the node, neighborhood
- ▶ FTTC: Fiber to the curb
- ▶ FTTB: Fiber to the building
- ▶ FTTH: Fiber to the home

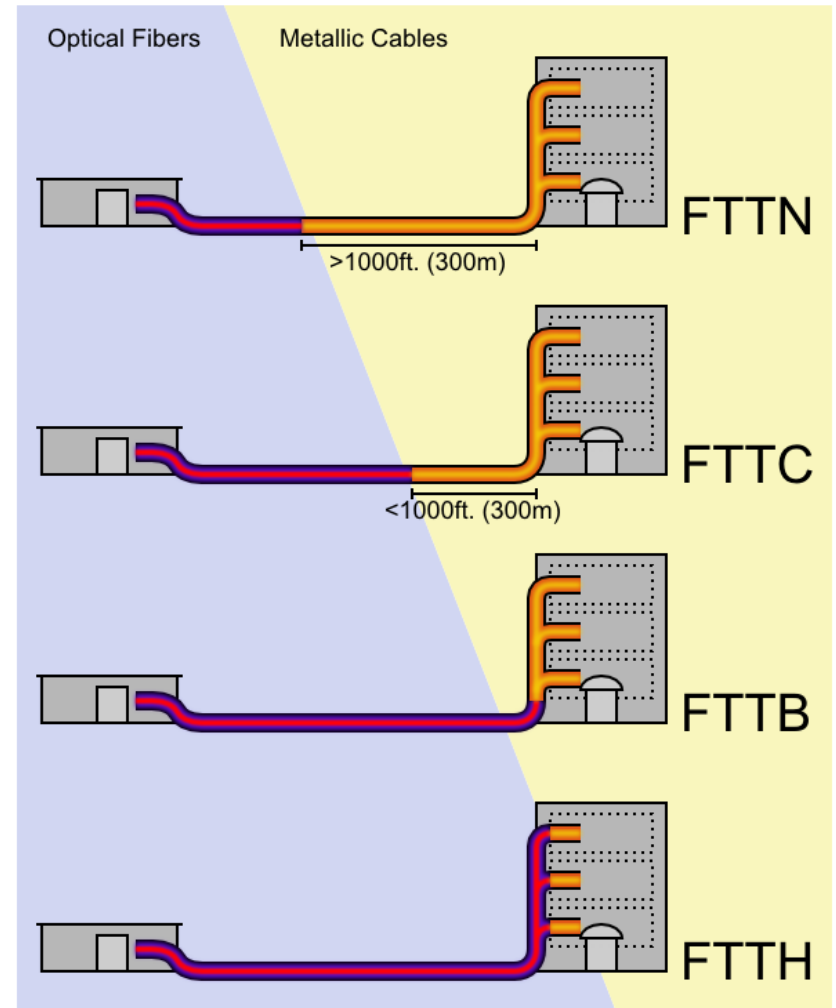

FDDI

- ▶ Fiber Distributed Data Interface

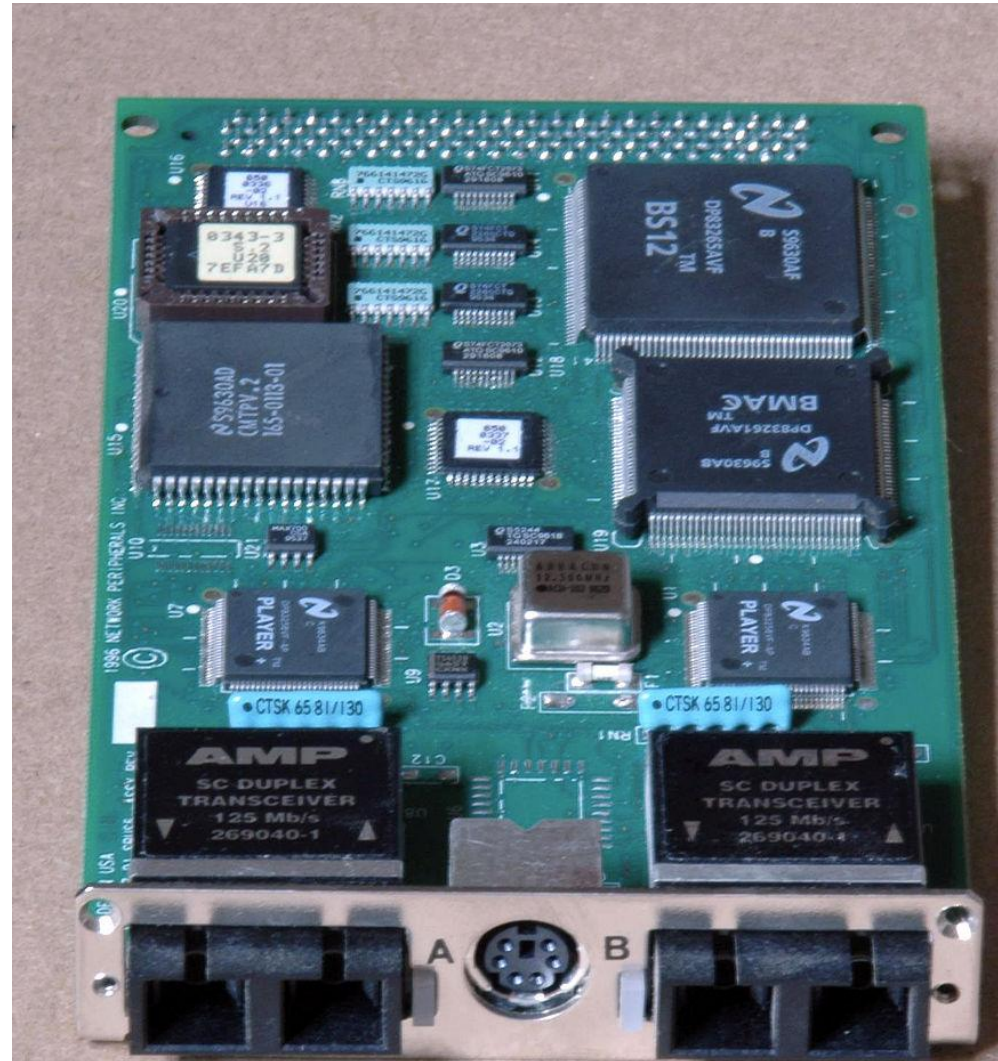

Cabluri, Conectori, rf-opto

rf-opto.etti.tuiasi.ro says
Request access!
OK

Microwave CD
Optoelectronics

Educational software

[Curs 3 OPTO 2020](#) (pdf, 9.01 MB, ro, 🇷🇴)

[Curs 4 OPTO Fibra 2020](#) (pdf, 8.18 MB, ro, 🇷🇴)

[Curs Fibra \(video, prezenta prin interfata examen\)](#) (mp4, 215.77 MB, ro, 🇷🇴)

Textbooks

[IBM Redbooks - Understanding Optical Communications](#) (pdf, 5.24 MB, en, 🇸🇪)

[Behzad Razavi - Design of Integrated Circuits for Optical Communications](#) (pdf, 11.18 MB, en, 🇸🇪)

[John Powers - An Introduction to Fiber Optic Systems](#) (pdf, 50.54 MB, en, 🇸🇪)

[Stefan Nilsson-Gistvik - Optical Fiber Theory for Communication Networks](#) (pdf, 17.62 MB, en, 🇸🇪)

[Structurii Optoelectronice](#) (pdf, 3.13 MB, ro, 🇷🇴)

[EU Photovoltaic Geographical Information System \(PVGIS\)](#) (link, 0 Bytes, en, 🇸🇪)

[MIT Course - Fundamentals of Photovoltaics](#) (link, 0 Bytes, en, 🇸🇪)

Laboratory

[Laborator 1](#) (pdf, 159.01 KB, ro, 🇷🇴)

[Laborator 2](#) (pdf, 269.94 KB, ro, 🇷🇴)

[Laborator 3](#) (pdf, 143.82 KB, ro, 🇷🇴)

[Laborator 4](#) (pdf, 156.42 KB, ro, 🇷🇴)

[Laborator 5](#) (pdf, 161.33 KB, ro, 🇷🇴)

[Laborator 6](#) (pdf, 138.19 KB, ro, 🇷🇴)

[Laborator 7](#) (pdf, 139.17 KB, ro, 🇷🇴)

Dimensionarea unei legături pe fibra optică

Capitolul 6



Cuprins

- ▶ **Lumina ca undă electromagnetică** (ecuațiile lui Maxwell, ecuația undelor, parametri de propagare)
- ▶ **Elemente de fotometrie și radiometrie** (mărimi energetice/luminoase)
- ▶ **Fibra optică** (realizare, principiu de funcționare, atenuare, dispersie, banda de frecvență)
- ▶ **Cabluri optice** (tehnologie, conectori, lipire – splice)
- ▶ **Proiectare sistemică a legăturii pe fibra optică** (bandă de frecvență, balanța puterilor)
- ▶ **Emițătoare optice** (LED și dioda laser – realizare fizică și funcționare)
- ▶ **Receptoare optice** (dioda PIN, dioda cu avalanșă – realizare fizică și funcționare)
- ▶ **Amplificatoare transimpedanță** (parametri, scheme tipice, TIA în buclă deschisă, cu reacție, diferențiale, control automat al câștigului)
- ▶ **Realizarea circuitelor pentru controlul emițătoarelor optice** (parametri, scheme tipice, controlul puterii, multiplexoare)
- ▶ **Dispozitive de captare a energiei solare** (principiu de funcționare, utilizare, proiectare)

Limite putere/bandă a dispozitivelor optoelectronice

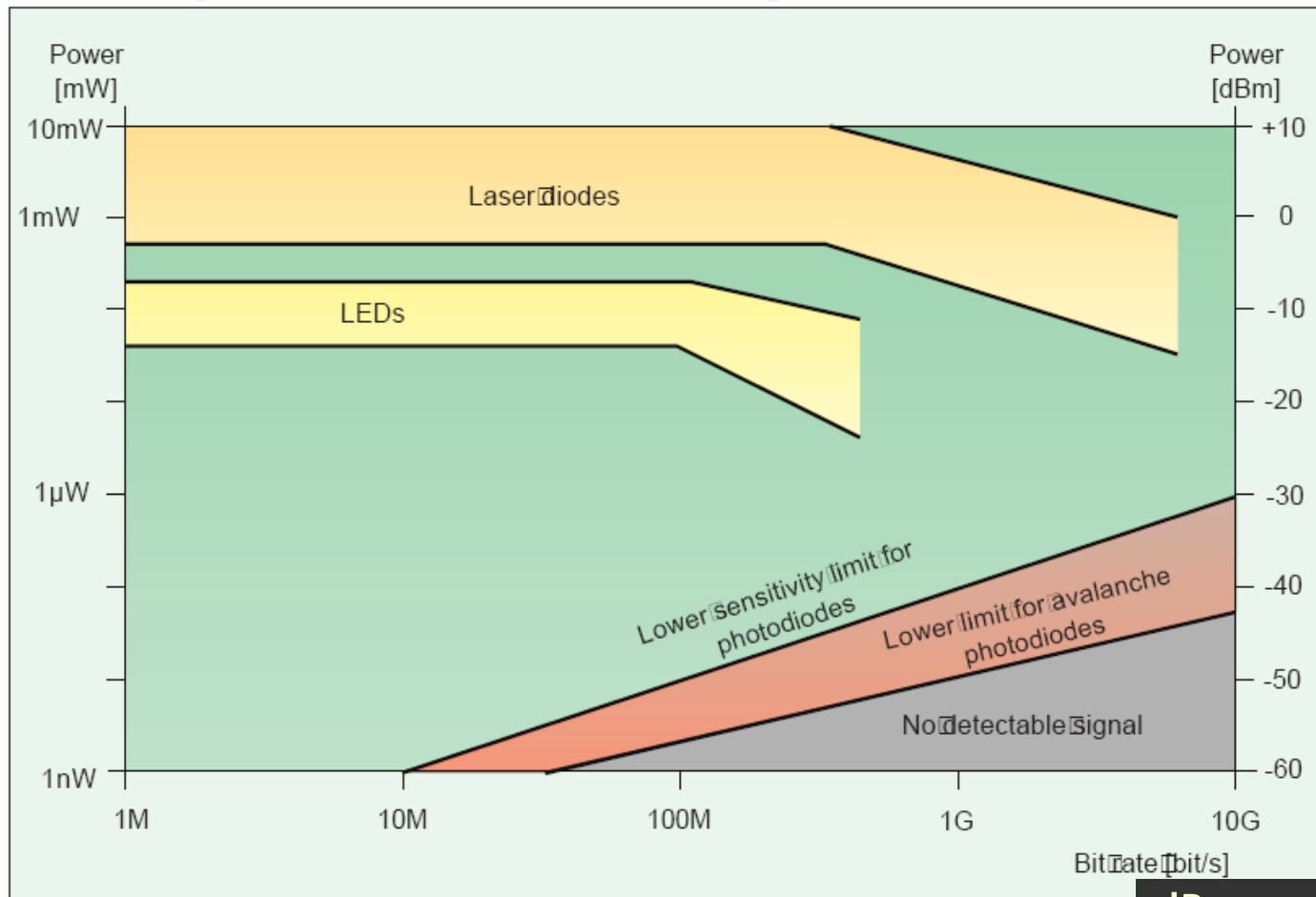

$$\text{dB} = 10 \cdot \log_{10} (P_2 / P_1)$$

$$\text{dBm} = 10 \cdot \log_{10} (P / 1 \text{ mW})$$

$$[\text{dBm}] + [\text{dB}] = [\text{dBm}]$$

Legatura pe fibra optica

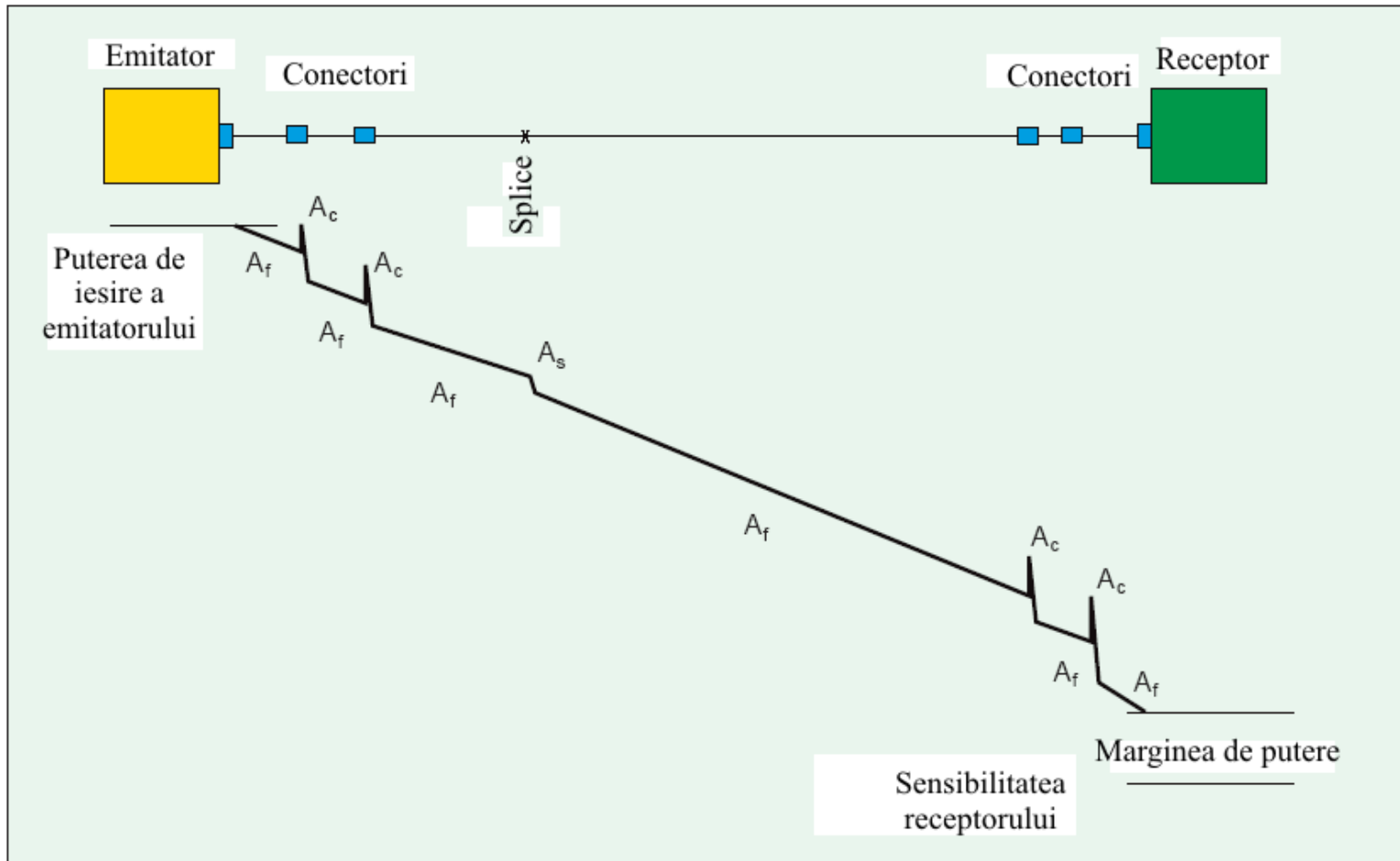

Atenuare

- ▶ Macrocurburi
 - utilizator, **localizat**, dB
- ▶ Discontinuitate in fibra
 - utilizator, **localizat**, dB
- ▶ Microcurburi
 - **distribuit**, tehnologie, dB/km
- ▶ Imprastiere
 - **distribuit**, tehnologie, dB/km
- ▶ Absorbție
 - **distribuit**, material, dB/km

Pierderi – Apertura numerica

- ▶ **Numai** la trecerea de la apertura numerica mai mare la apertura numerica mai mica

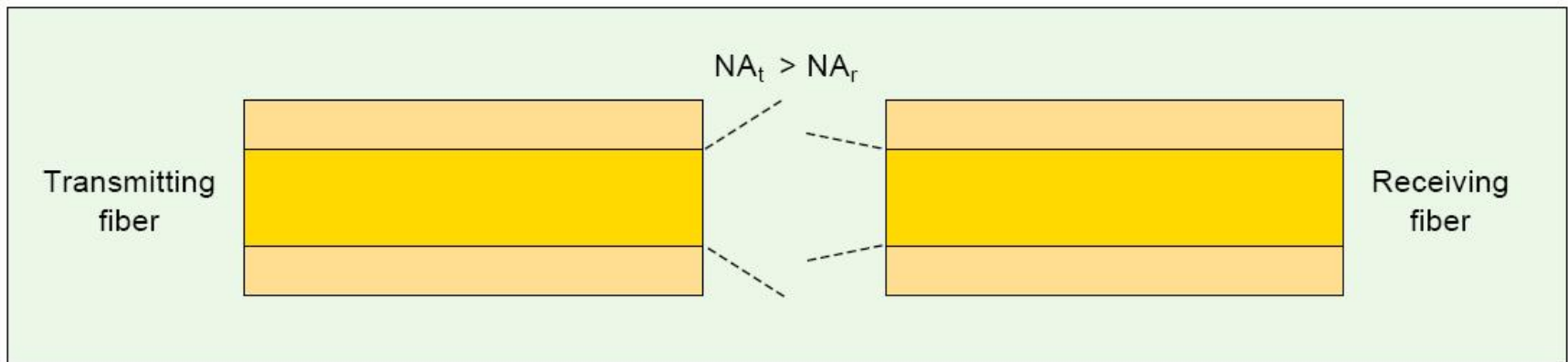

$$\text{Atenuare}_{NA}[\text{dB}] = -10 \cdot \log_{10} \left(\frac{NA_r}{NA_t} \right)^2$$

numai pentru $NA_r < NA_t$

$$\text{Atenuare}_{NA}[\text{dB}] > 0$$

Pierderi – Diametrul miezului

- ▶ **Numai** la trecerea de la diametru mai mare la diametru mai mic (multimod)
- ▶ **Bidirectional** (monomod)

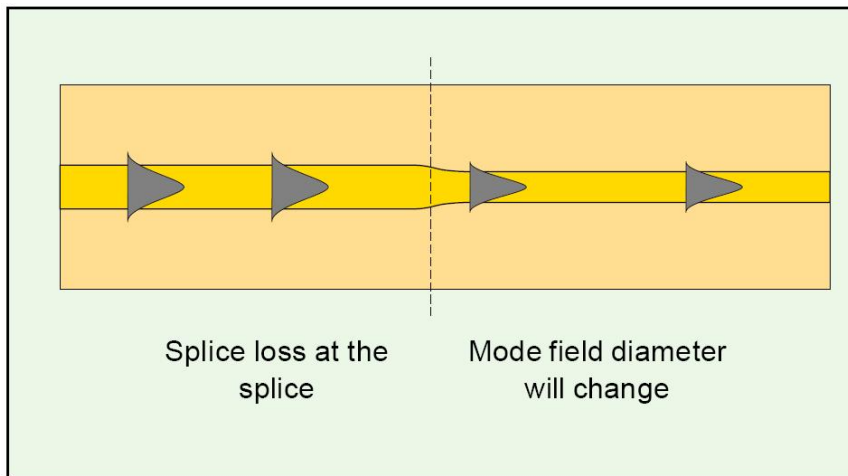

- ▶ multimod

$$\text{Atenuare}_\Phi [\text{dB}] = -10 \cdot \log_{10} \left(\frac{\phi_r}{\phi_t} \right)^2$$

numai pentru $\Phi_r < \Phi_t$

- ▶ monomod

$$\text{Atenuare}_\Phi [\text{dB}] = -20 \cdot \log_{10} \left(\frac{2 \cdot w_1 \cdot w_2}{w_1^2 + w_2^2} \right)$$

bidirectional $\forall w_1, w_2$

w = MFD !!

$$\text{Atenuare}_\Phi [\text{dB}] > 0$$

Pierderi

- ▶ multimod

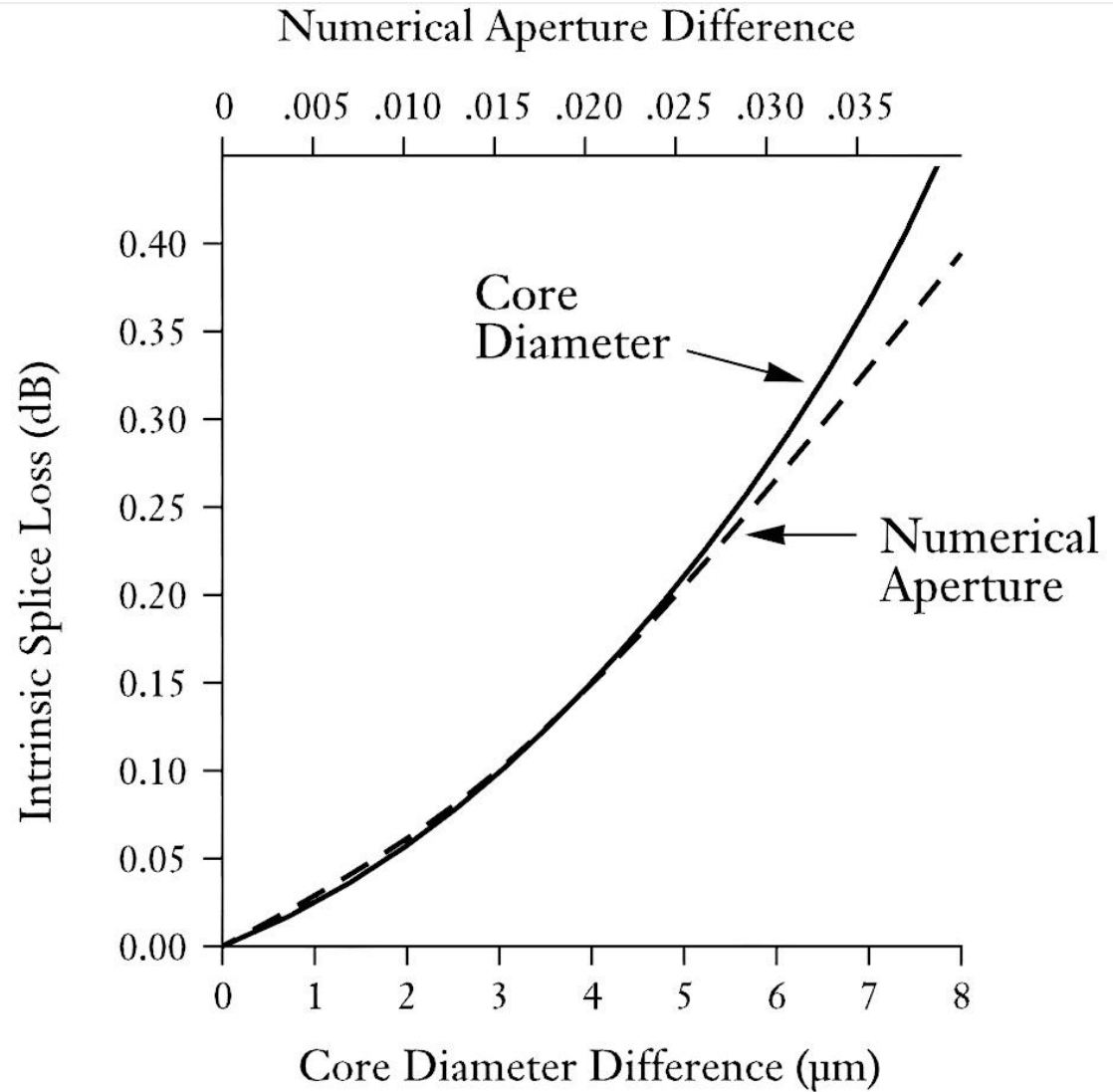

Pierderi

- ▶ monomod
 - predomina pierderile datorate diferentelor de MFD
 - se poate neglija NA
 - **Bidirectional** (MFD mic → mare **si** mare → mic)

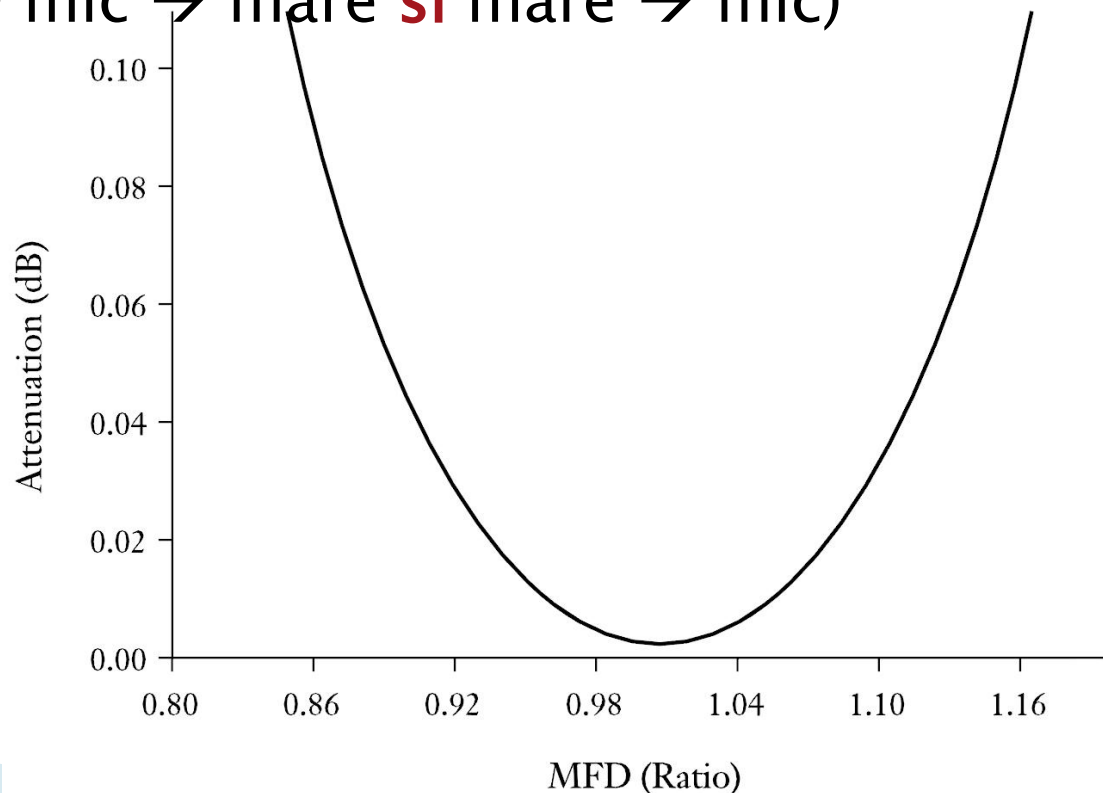

Pierderi

- ▶ monomod
- ▶ tipic: cel mai dezavantajos pentru MFD = $9.3 \pm 0.5 \mu\text{m}$ \rightarrow $A = 0.04\text{dB}$

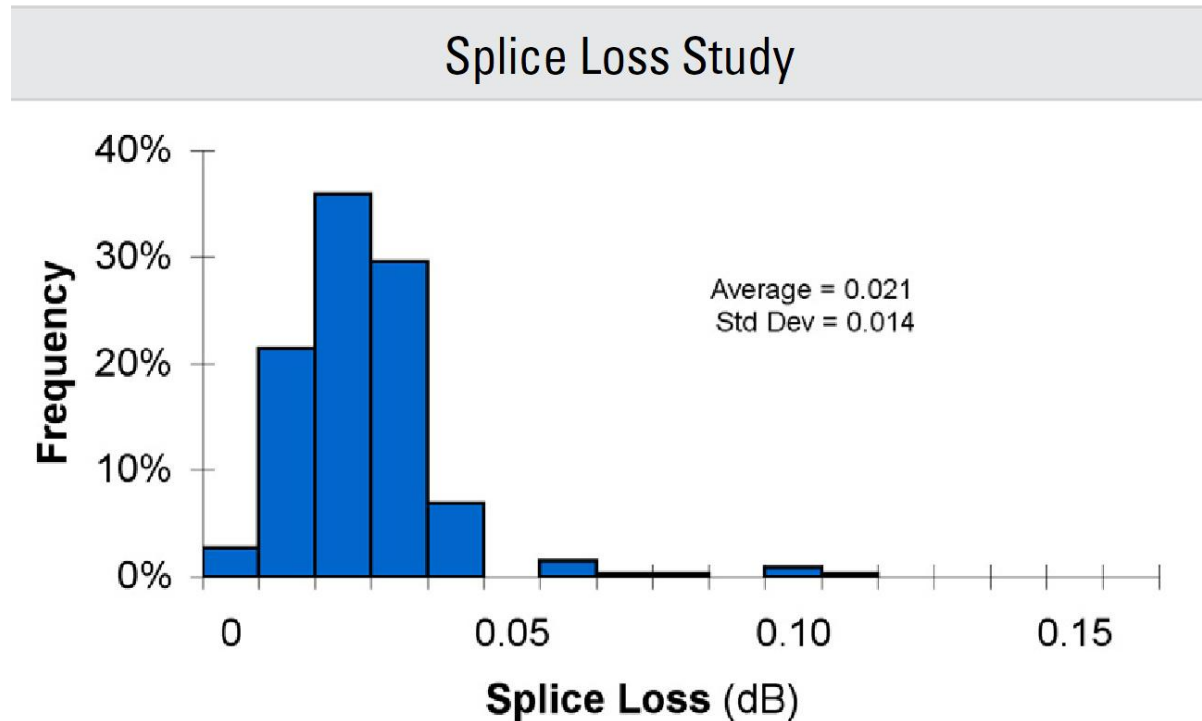

Pierderi – Nealinierarea axelor

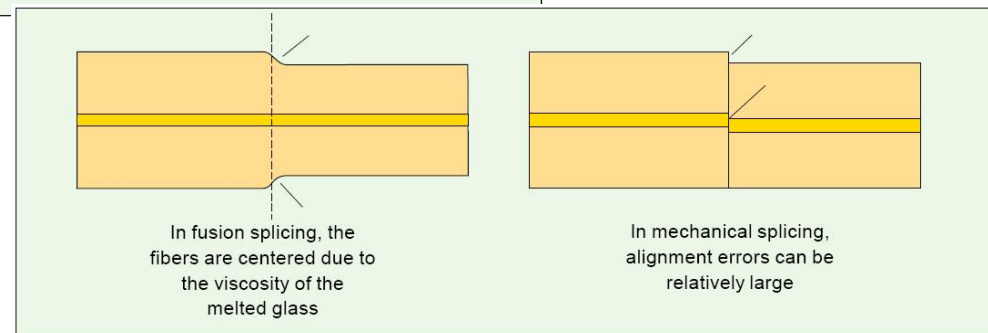
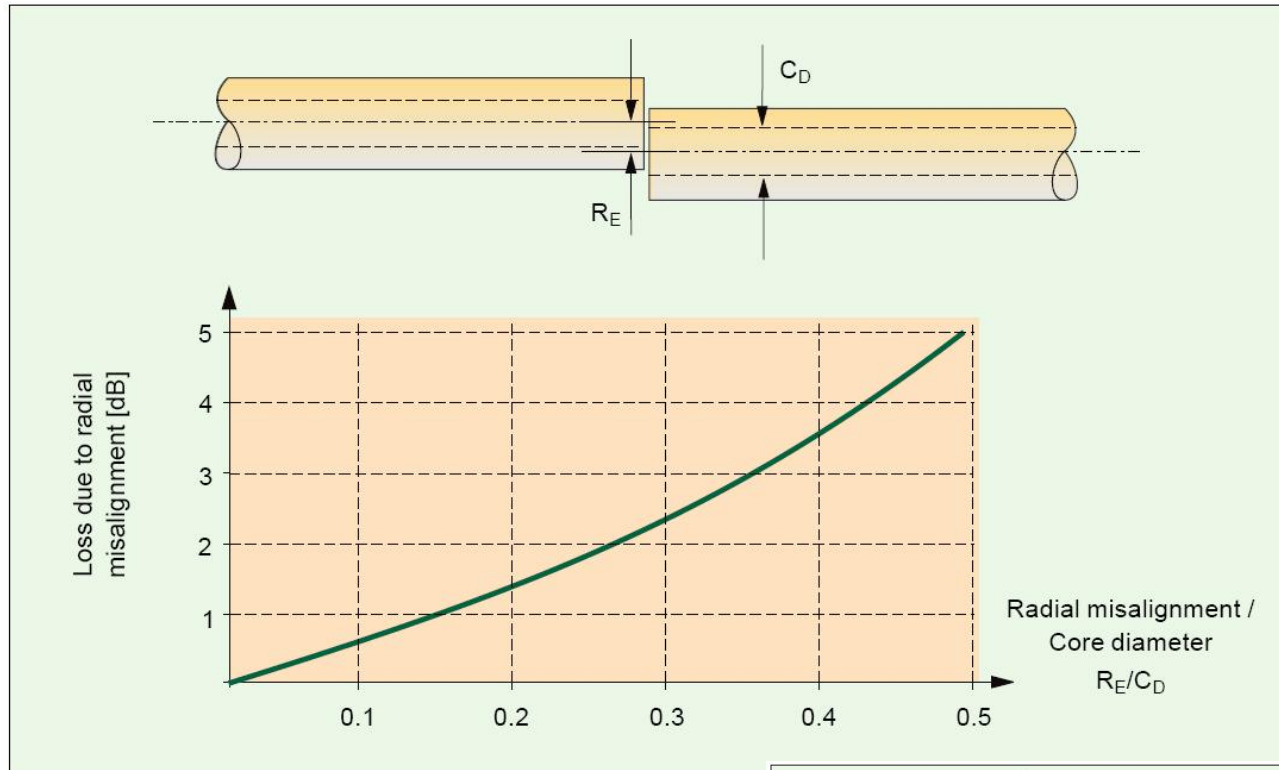

Pierderi – unghi

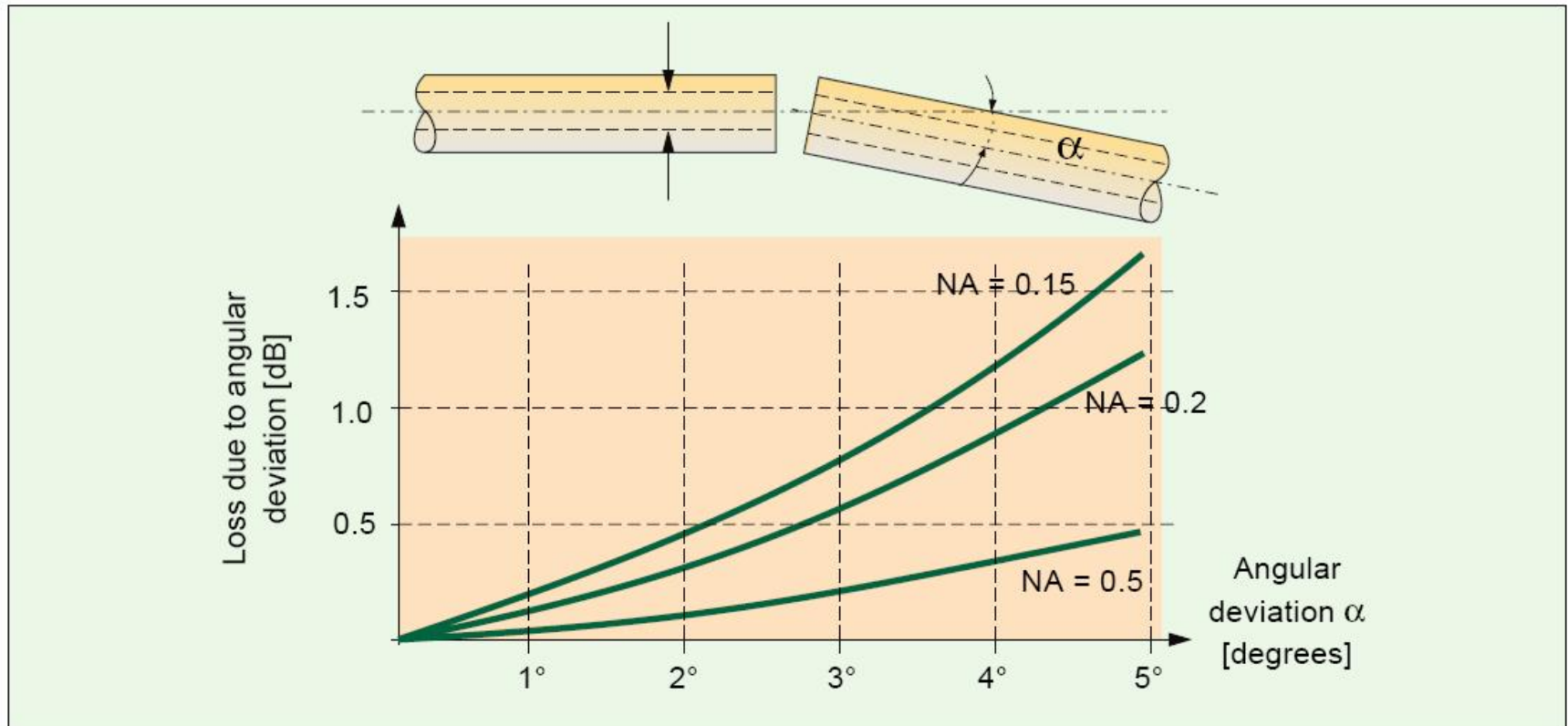

Pierderi – distanta

- ▶ Se foloseste un gel cu indice de refractie egal cu al fibrelor
- ▶ Se aduna pierderile generate de reflexie pe o lamela (pana la 16%)

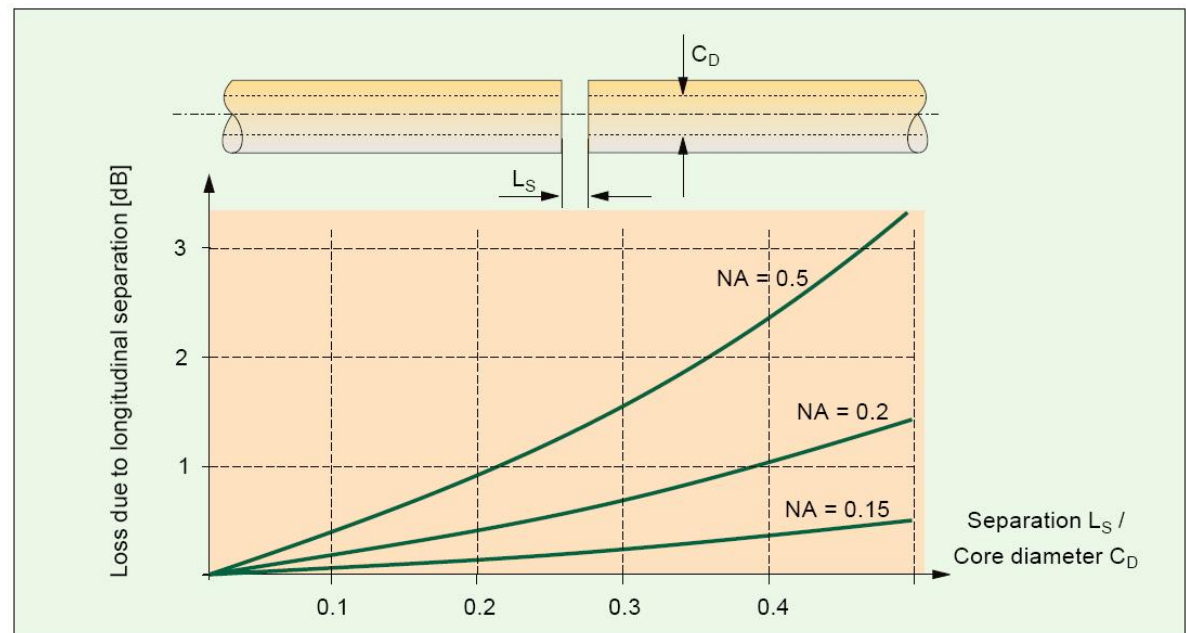

Exemplu

- ▶ Trebuie să realizați o legătură pe fibră optică pe o distanță de 50 km la o viteză de 1Gb/s.

Emitători: = 1.5mW ($\Delta\lambda=2\text{nm}$, diverse λ)	NA = 0.17	$\Phi = 13\mu\text{m}$
Pierderi splice (tehnologie)	0.15 dB/splice	
Pierderi conector	0.5 dB/conector	
Cablu conexiune: L = 20m	NA = 0.12	fibră: 11/125 μm
Cablu conexiune: L = 20m	NA = 0.15	fibră: 11/125 μm
Fibra 1	8 X 5km	
Fibra 2	4 X 10km	
Fibra 3	8 X 5km	
Fibra 4	4 X 10km	
Receptor: Sensitivitate = 1 μW	NA = 0.25	$\Phi = 30\mu\text{m}$

Catalog

Fibra nr. 3

Optical Specifications

Fiber Attenuation

Maximum Attenuation	
Wavelength (nm)	Maximum Value* (dB/km)
1310	0.33 - 0.35
1383**	0.31 - 0.35
1490	0.21 - 0.24
1550	0.19 - 0.20
1625	0.20 - 0.23

*Maximum specified attenuation value available within the stated ranges.
 **Attenuation values at this wavelength represent post-hydrogen aging performance.
 Alternate attenuation offerings available upon request.

Attenuation vs. Wavelength

Range (nm)	Ref. λ (nm)	Max. α Difference (dB/km)
1285 - 1330	1310	0.03
1525 - 1575	1550	0.02

The attenuation in a given wavelength range does not exceed the attenuation of the reference wavelength (λ_r) by more than the value α .

Macro-bend Loss

Mandrel Diameter (mm)	Number of Turns	Wavelength (nm)	Induced Attenuation* (dB)
32	1	1550	≤ 0.03
50	100	1310	≤ 0.03
50	100	1550	≤ 0.03
60	100	1625	≤ 0.03

*The induced attenuation due to fiber wrapped around a mandrel of a specified diameter.

Point Discontinuity

Wavelength (nm)	Point Discontinuity (dB)
1310	≤ 0.05
1550	≤ 0.05

Dimensional Specifications

Glass Geometry

Fiber Curl	≥ 4.0 m radius of curvature
Cladding Diameter	125.0 ± 0.7 μ m
Core-Clad Concentricity	≤ 0.5 μ m
Cladding Non-Circularity	$\leq 0.7\%$

Environmental Specifications

Environmental Test	Test Condition	Induced Attenuation	
		1310 nm, 1550 nm & 1625 nm	(dB/km)
Temperature Dependence	-60°C to +85°C*		≤ 0.05
Temperature Humidity Cycling	-10°C to +85°C* up to 98% RH		≤ 0.05
Water Immersion	23 \pm 2°C*		≤ 0.05
Heat Aging	85 \pm 2°C*		≤ 0.05

*Reference temperature = +23°C

Operating Temperature Range: -60°C to +85°C

Cable Cutoff Wavelength (λ_{ccf})

$\lambda_{ccf} \leq 1260$ nm

Mode-Field Diameter

Wavelength (nm)	MFD (μ m)
1310	9.4 \pm 0.4
1550	10.6 \pm 0.5

Dispersion

Wavelength (nm)	Dispersion Value [ps/(nm \cdot km)]
1550	≤ 18
1625	≤ 23

Zero Dispersion Wavelength (λ_0): 1310 nm $\leq \lambda_0 \leq$ 1324 nm
 Zero Dispersion Slope (S_0): ≤ 0.092 ps/(nm \cdot km)

Polarization Mode Dispersion (PMD)

PMD Link Design Value	Value (ps \sqrt km)
Maximum Individual Fiber	≤ 0.2

*Complies with IEC 60794-3: 2001, Section 5.5, Method 1, September 2001.

The PMD link design value is a term used to describe the PMD of concatenated lengths of fiber (also known as PMD₀). This value represents a statistical upper limit for total link PMD. Individual PMD values may change when cabled. Corning's fiber specification supports network design requirements for a 0.5 ps \sqrt km maximum PMD.

Coating Geometry

Coating Diameter	245 \pm 5 μ m
Coating-Cladding Concentricity	< 12 μ m

Mechanical Specifications

Proof Test

The entire fiber length is subjected to a tensile stress ≥ 100 kpsi (0.7 GPa)*.

*Higher proof test levels available.

Length

Fiber lengths available up to 50.4* km/spool.
 *Longer spliced lengths available.

Performance Characterizations

Characterized parameters are typical values.

Core Diameter	8.2 μ m
Numerical Aperture	0.14
	NA is measured at the one percent power level of a one-dimensional far-field scan at 1310 nm.

Zero Dispersion Wavelength (λ_0)

1317 nm

Zero Dispersion Slope (S_0)

0.088 ps/(nm \cdot km)

Effective Group Index of Refraction (N_{eff})

1310 nm: 1.4670

1550 nm: 1.4677

Fatigue Resistance Parameter (N_f)

20

Coating Strip Force

Dry: 0.6 lbs. (3N)

Wet, 14-day room temperature: 0.6 lbs. (3N)

Rayleigh Backscatter Coefficient (for 1 μ s Pulse Width)

1310 nm: -77 dB

1550 nm: -82 dB

Stimulated Brillouin Scattering Threshold

20 dBm¹

Notes:

(1) When characterized with a transmitter specifying 17 dBm SBS threshold over standard single-mode fiber. While absolute SBS threshold is a function of distance and signal format, NexCor fiber offers a 3 dB improvement over standard single-mode fiber independent of these variables.

Formulas

Dispersion

$$\text{Dispersion} = D(\lambda) = -\frac{S_0}{\lambda} \left[\lambda - \frac{\lambda_0}{\lambda} \right] \text{ ps/(nm}\cdot\text{km)}$$

for 1200 nm $\leq \lambda \leq$ 1625 nm

λ = Operating Wavelengths

Cladding Non-Circularity

$$\text{Cladding Non-Circularity} = \left[\frac{\text{Min. Cladding Diameter}}{\text{Max. Cladding Diameter}} \right] \times 100$$

How to Order

Contact your sales representative, or call the Optical Fiber Customer Service Department:
 Ph: 607-248-2000 (U.S. and Canada)
 +44-1244-287-4317 (Europe)
 Email: opticalfibres@corning.com
 Please specify the fiber type, attenuation and quantity when ordering.

Corning Incorporated

www.corning.com/opticalfiber

One Riverfront Plaza
 Corning, NY 14831
 U.S.A.

Ph: 800-525-2324 (U.S. and Canada)

607-786-8125 (International)

Fx 800-539-3632 (U.S. and Canada)

607-786-8344 (International)

Email: cofc@corning.com

Europe

Ph: 00 800 6620 6621 (U.K., Ireland, Italy,

France, Germany, The Netherlands,

Spain and Sweden)

+1 607 786 8125 (All Other Countries)

Fx: +1 607 786 8344

Asia Pacific

Australia

Ph: 1-800-148-690

Fx: 1-800-148-568

Indonesia

Ph: 001-800-015-721-1261

Fx: 001-800-015-721-1262

Malaysia

Ph: 1-800-80-3156

Fx: 1-800-80-3155

Philippines

Ph: 1-800-1-116-0338

Fx: 1-800-1-116-0339

Singapore

Ph: 800-1300-955

Fx: 800-1300-956

Thailand

Ph: 001-800-1-1-721-1261

Fx: 001-800-1-1-721-1264

Latin America

Brazil

Ph: 00817-762-4732

Fx: 00817-762-4996

Mexico

Ph: 001-800-235-1719

Fx: 001-800-339-1472

Venezuela

Ph: 800-1-4418

Fx: 800-1-4419

Greater China

Email: CCcofc@corning.com

Beijing

Ph: (86) 10-6505-5066

Fx: (86) 10-6505-5077

Hong Kong

Ph: (852) 2807-2723

Fx: (852) 2807-2152

Shanghai

Ph: (86) 21-3222-4668

Fx: (86) 21-6288-1575

Taiwan

Ph: (886) 2-2716-0338

Fx: (886) 2-2716-0339

NexCor is a trademark, and Corning and SMU-28c are registered trademarks, of Corning Incorporated, Corning, N.Y.

Any warranty on any assets relying on any Corning optical fiber is only contained in the written agreement between Corning Incorporated and the direct purchaser of such fiber.

©2003 Corning Incorporated

Intrebari

- ▶ (1 p) Ce lungime de undă veți alege pentru emițător? Justificați.
- ▶ (2p) Alegeți fibrele pe care le veți utiliza. Justificați. Realizați schița legăturii
- ▶ (1 p) Puteți realiza o legătură funcțională? Justificați.

<i>Zero Dispersion Wavelength (λ_0)</i>	1317 nm
<i>Zero Dispersion Slope (S_0)</i>	0.088 ps/(nm ² •km)

Legatura

► Bilantul puterilor

$$A_{tot} [\text{dB}] = \sum_i A_i [\text{dB}]$$

$$P_e [\text{dBm}] \pm A_{tot} [\text{dB}] \geq S_r [\text{dBm}] + M [\text{dB}]$$

Maximum Attenuation

Wavelength (nm)	Maximum Value* (dB/km)
1310	0.33 – 0.35
1383**	0.31 – 0.35
1490	0.21 – 0.24
1550	0.19 – 0.20
1625	0.20 – 0.23

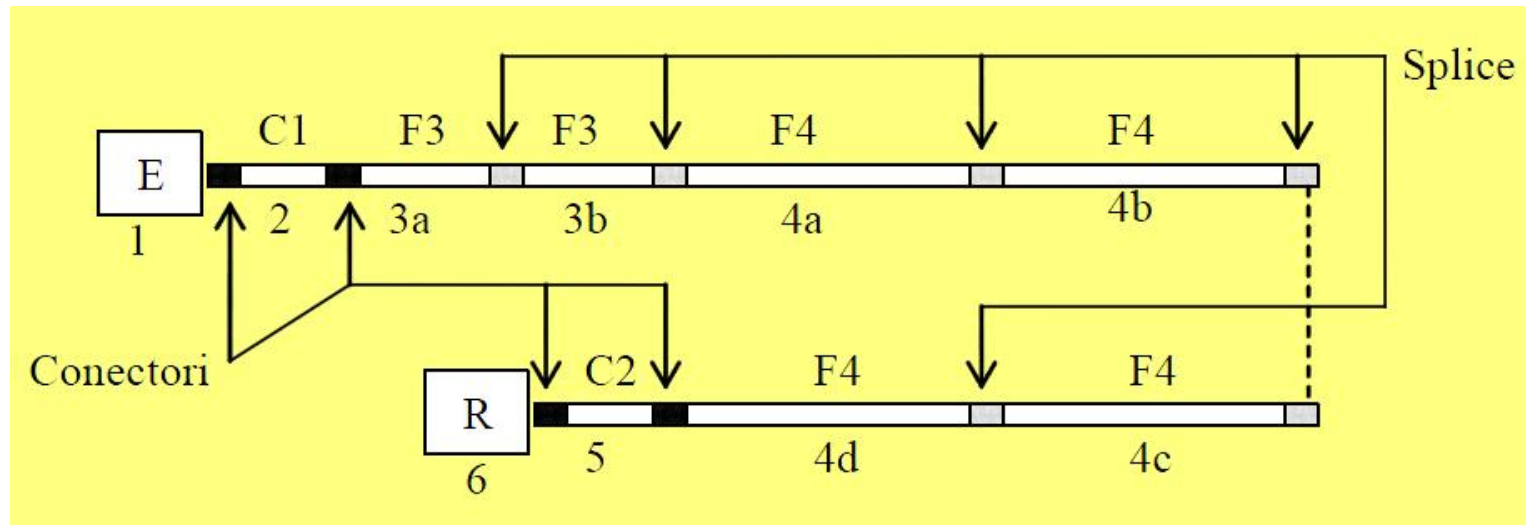

Sistem

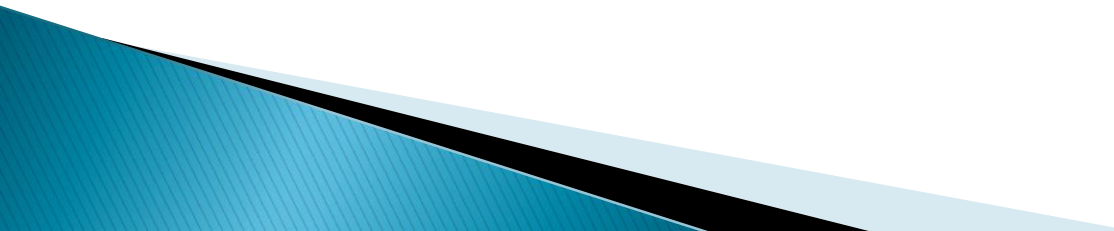
- ▶ 1. Emitator
 - ▶ 2. Cablu 1 de conexiune
 - ▶ 3. Fibra 3 (2 cabluri a 5 km fiecare: 3a,3b)
 - ▶ 4. Fibra 4 (4 cabluri a 10 km fiecare: 4a,4b,4c,4d)
 - ▶ 5. Cablu 2 de conexiune
 - ▶ 6. Receptor
- 

Atenuare

▶ Distribuita

- microcurburi
- imprastiere
- absorbtie

$$\text{Atenuare}_D [\text{dB/km}] = \frac{\text{Pierderi}[\text{dB}]}{\text{lungime}[\text{km}]}$$

▶ Localizata

- macrocurburi
- conectori
- splice
- tranzitii

$$\text{Atenuare}_L [\text{dB}] = \text{Pierderi}[\text{dB}]$$

$$A_{\text{TOT}} [\text{dB}] = A_L [\text{dB}] + A_D [\text{dB/km}] \cdot L [\text{km}]$$

Pierderi

- ▶ Atenuare in fibra
- ▶ Atenuare datorata conectorilor
- ▶ Atenuare datorata splice-urilor
- ▶ Atenuare datorata diferentelor de apertura numerica
 - apare **numai** la trecerea de la un dispozitiv cu NA mai mare la un dispozitiv cu NA mai mic
 - **neglijabil** intre 2 fibre monomod sudate
- ▶ Atenuare datorata diferentelor de diametru
 - apare **numai** la trecerea de la un dispozitiv cu diametru mai mare la un dispozitiv cu diametru mai mic
 - **bidirectional** la fibre monomod sudate

Dispersie

$$\Delta\tau_{\text{mod}} \cong \frac{L \cdot n_2 \cdot \Delta}{2\sqrt{3} \cdot c} \approx \frac{L \cdot NA^2}{4\sqrt{3} \cdot c \cdot n_2}$$

$$\Delta\tau_{\text{mod}} \cong \frac{L \cdot n_2 \cdot \Delta^2}{4\sqrt{3} \cdot c} \cong \frac{L \cdot NA^4}{16\sqrt{3} \cdot c \cdot n_2^3}$$

$$\Delta\tau_{cr} = D(\lambda) \cdot \Delta\lambda \cdot L$$

$$D(\lambda) = \frac{S_0}{4} \cdot \left(\lambda - \frac{\lambda_0^4}{\lambda^3} \right)$$

$$\Delta\tau_{tip} = \sum_i \Delta\tau_i$$

$$\Delta\tau_{tot} = \sqrt{\Delta\tau_{cr}^2 + \Delta\tau_{mod}^2}$$

$$B_{opt} = \frac{0.44}{\Delta\tau_{tot} [ns]} [GHz] \quad B_{opt} = \sqrt{2} B_{el}$$

$$V [Gb/s] \cong 2 \cdot B_{el}$$

$$B_{3dB, electric} (GHz) = \frac{0.35}{T(ns)}$$

$$NRZ_{viteza\ data} (Gbit/s) = \frac{1}{T_{impuls} (ns)} \leq \frac{0.67}{T(ns)}$$

Sisteme cu mai multe tipuri de fibra

- ▶ Fibra tip 1 conectata/sudata cu fibra tip 2
- ▶ efecte **succesive** se adună liniar
- ▶ la nivelul splice-ului apare o atenuare **localizata**:
 - atenuare pe splice/conector
 - atenuare datorita **NA** diferit (**daca** este cazul)
 - atenuare datorita **Φ** diferit (**daca** este cazul)

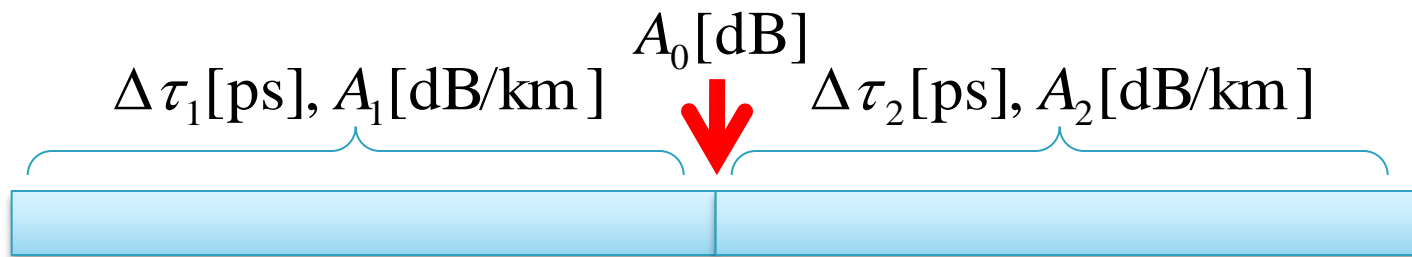

$$A_{tot} [\text{dB}] = A_1 [\text{dB/km}] \cdot L_1 [\text{km}] + A_2 [\text{dB/km}] \cdot L_2 [\text{km}] + A_0 [\text{dB}]$$

$$\Delta\tau_{tot} = \Delta\tau_1 + \Delta\tau_2$$

Sisteme cu mai multe tipuri de fibra

- ▶ efecte **succesive** se adună liniar

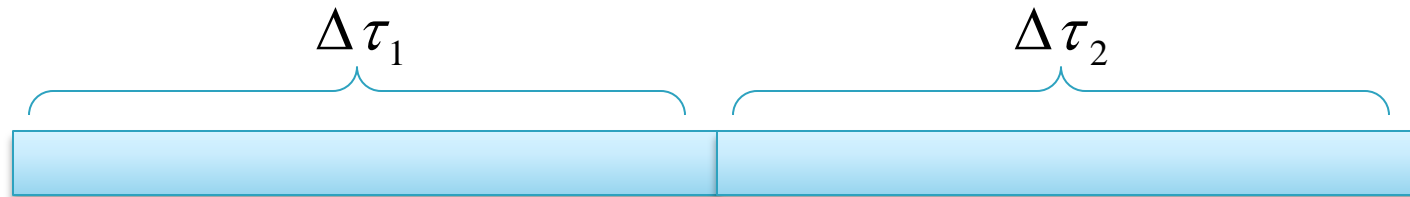

$$\Delta\tau_{tot} = \Delta\tau_1 + \Delta\tau_2$$

- ▶ dar pe fiecare fibra exista efecte **simultane** (pentru dispersie) care se adună pătratic

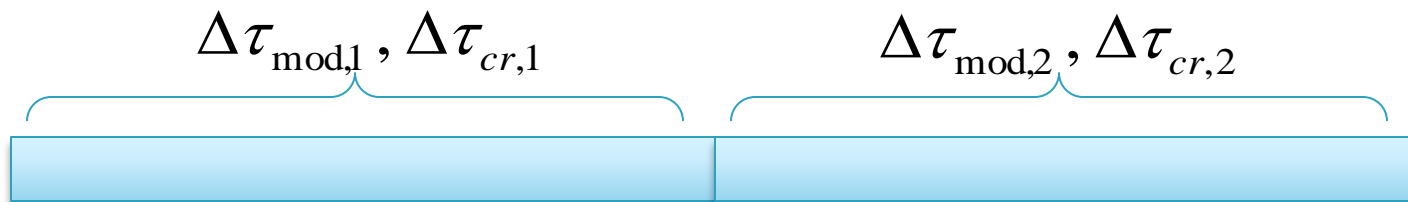

$$\Delta\tau_1 = \sqrt{\Delta\tau_{cr,1}^2 + \Delta\tau_{mod,1}^2}$$

$$\Delta\tau_2 = \sqrt{\Delta\tau_{cr,2}^2 + \Delta\tau_{mod,2}^2}$$

Sisteme cu acelasi tip de fibra

- ▶ N tronsoane cu acelasi tip de fibra conectate/sudate
 - atenuare datorita NA **nula (acelasi tip)**
 - atenuare datorita Φ **nula (acelasi tip)**
 - atenuare pe splice/conector: N-1 conectori
 - lungime totala: $L_{tot} [\text{km}] = \sum_1^N L_i [\text{km}]$
- ▶ efecte **sucsesive** se adună liniar
- ▶ efectele (dispersie si atenuare) proportionale cu distanta

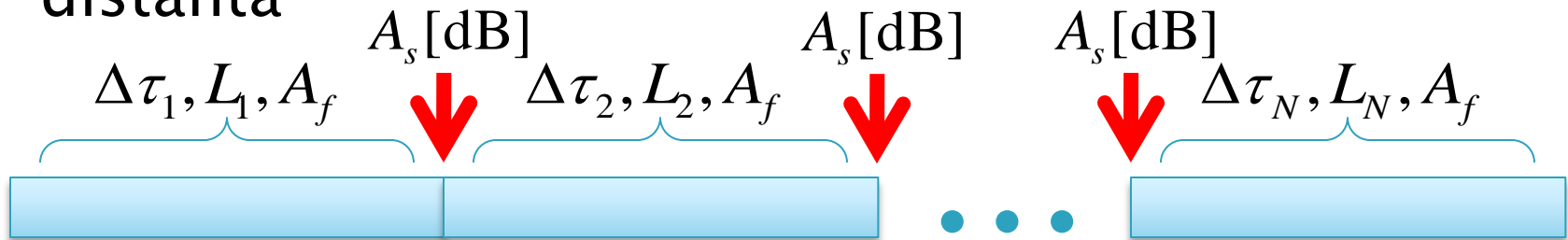

$$\Delta\tau_{tot} = \sum_{i=1}^N \Delta\tau(L_i) = \Delta\tau(L_{tot}) = \sqrt{\Delta\tau_{cr}(L_{tot})^2 + \Delta\tau_{mod}(L_{tot})^2}$$

$$A_{tot} [\text{dB}] = A_f [\text{dB/km}] \cdot L_{tot} [\text{km}] + (N-1) \cdot A_s [\text{dB}]$$

Produs Banda · Distanta

$$\Delta\tau_{\text{mod}} \cong \frac{L \cdot n_2 \cdot \Delta}{2\sqrt{3} \cdot c} \approx \frac{L \cdot NA^2}{4\sqrt{3} \cdot c \cdot n_2}$$

$$\Delta\tau_{\text{tot}} = \sqrt{\Delta\tau_{\text{cr}}^2 + \Delta\tau_{\text{mod}}^2}$$

$$\Delta\tau_{\text{cr}} = D(\lambda) \cdot \Delta\lambda \cdot L$$

$$\Delta\tau_{\text{tot}} = \text{const} \cdot L$$

$$B_{\text{opt}} = \frac{0.44}{\Delta\tau_{\text{tot}} [\text{ns}]} \quad [\text{GHz}]$$

$$B_{\text{opt}} = \sqrt{2} B_{\text{el}}$$

$$V [\text{Gb/s}] \cong 2 \cdot B_{\text{el}}$$

$$V [\text{Gb/s}] \cong \frac{\text{const}}{L}$$

$$V [\text{Gb/s}] \cdot L [\text{km}] \cong \text{const}$$

Lungime maxima

- ▶ **limitata de atenuare**
- ▶ lungimea cea mai mare la care pot face transmisia este obtinuta in cazul cel mai defavorabil
 - cele mai mici pierderi permise
 - atenuare distribuita maxima

$$A_{\text{TOT}}[\text{dB}] = A_L[\text{dB}] + A_D[\text{dB/km}] \cdot L[\text{km}]$$

$$\text{Atenuare}[\text{dB/km}] = \frac{\text{Pierderi}_D[\text{dB}]}{\text{lungime}[\text{km}]} \quad L_{\text{max}} \Rightarrow \Delta P_{\text{min}}, A_{D\text{max}}$$

$$L_{\text{max}} = \frac{\Delta P_{\text{min}}[\text{dB}]}{A_{D\text{max}}[\text{dB/km}]} = \frac{P_{e\text{min}}[\text{dBm}] - S_{r\text{max}}[\text{dBm}] - A_L[\text{dB}]}{A_{D\text{max}}[\text{dB/km}]}$$

de obicei problema distantei maxime limitate de atenuare se pune pentru fibre **monomod**

Lungime maxima

- ▶ **limitata de viteza**
- ▶ lungimea cea mai mare la care pot face transmisia este obtinuta in cazul cel mai defavorabil
 - dispersie maxima
- ▶ doua cazuri in functie de cum e specificata dispersia
 - $B \times L$ [MHz · km]
 - S_0 [ps/nm²/km], λ_0 [nm]

$$B_{elmin} \cong \frac{V_{min} [Gb/s]}{2}$$

$$\Delta\tau_{tot\ max} [ns]$$

$$B_{opt\ min} = \sqrt{2} B_{elmin}$$

$$\Delta\tau_{tot\ max} [ns] = \frac{0.44}{B_{opt\ min} [GHz]}$$

$$L_{max} = \frac{\Delta\tau_{tot\ max}}{D(\lambda) \cdot \Delta\lambda}$$

$$B \times L [MHz \cdot km]$$

$$L_{max} [km] = \frac{B \times L [MHz \cdot km]}{B_{elmin} [MHz]}$$

Lungime maxima

- ▶ **limitata de atenuare** $L_{\max}^a [\text{km}]$
- ▶ **limitata de viteza** $L_{\max}^v [\text{km}]$

- ▶ lungimea cea mai mare la care pot face transmisia este obtinuta in cazul cel mai defavorabil (din cele doua limitari)

$$L_{\max} [\text{km}] = \min(L_{\max}^a [\text{km}], L_{\max}^v [\text{km}])$$

- ▶ **de obicei**
 - monomod: limita impusa de atenuare
 - cu exceptia cazurilor in care nu se functioneaza la λ optim dpdv al dispersiei
 - multimod: limita impusa de viteza

Calculul atenuarii

$$\text{Pierderi} = \frac{P_{out}}{P_{in}}$$

$$\text{Pierderi[dB]} = [-] 10 \cdot \log_{10} \left(\frac{P_{out}}{P_{in}} \right)$$

$$\text{Pierderi [dB]} = [-] (P_{out} [\text{dBm}] - P_{in} [\text{dBm}])$$



=



-

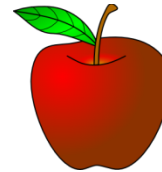

$$\text{Atenuare[dB/km]} = \frac{\text{Pierderi[d B]}}{\text{lungime[km]}}$$

Problema simpla?

- ▶ Sursa luminoasa: 7.7 dBm
- ▶ Atenuarea fibrei: 1.16 dB/km
- ▶ Puterea la iesire: 105 μ W

- ▶ Lungimea fibrei: ?

Problema simpla?

▶ Logaritmic

- $P_{\text{out}} = 10 \cdot \log(105 \mu\text{W}/1 \text{ mW}) = -9.8 \text{ dBm} !$
- Atenuarea : $A_f = P_{\text{in}}[\text{dBm}] - P_{\text{out}}[\text{dBm}] = 17.5 \text{ dB} !$
- $L = A_f / A_{\text{dB/km}} = 17.5 \text{ dB} / 1.16 \text{ dB/km} = 15.08 \text{ km}$

▶ Liniar

- $P_{\text{in}} = 1 \text{ mW} \cdot 10^{7.7/10} = 5.888 \text{ mW}$
- Atenuarea : $A_f = P_{\text{in}} / P_{\text{out}} = 5.888 \text{ mW} / 0.105 \text{ mW} = 56.0762 [1] !$
- Atenuarea pe unitatea de lungime $A_{1/\text{km}} = 10^{1.16/10} = 1.3062 [1] !$
- $A_f = (A_{1/\text{km}})^{L/1\text{km}} \rightarrow L = 1 \text{ km} \cdot \log(A_f) / \log(A_{1/\text{km}}) = 1.749 / 0.116 \text{ km} = 15.08 \text{ km}$

Problema simpla? 2

- ▶ Sursa luminoasa: 4.9 dBm
- ▶ Atenuarea fibrei: 0.32 dB/km
- ▶ Lungimea fibrei: 17 km

- ▶ Puterea la iesire: ? [μ W]

Problema simpla? 2

▶ Logaritmic

- Atenuarea : $A_f = A_{\text{dB/km}} \cdot L[\text{km}] = 5.44 \text{ dB}$
- $P_{\text{out}}[\text{dBm}] = P_{\text{in}}[\text{dBm}] - A_f [\text{dB}] = -0.54 \text{ dBm} !$
- $P_{\text{out}} = 1 \text{ mW} \cdot 10^{-0.54/10} = 0.883 \text{ mW} = 883 \text{ } \mu\text{W}$

▶ Liniar

- Atenuarea : $A_f [\text{dB}] = A_{\text{dB/km}} \cdot L[\text{km}] = 5.44 \text{ dB} !$
- Atenuarea : $A_f [1] = 10^{A_f [\text{dB}] / 10} = 3.499 [1] !$
- $P_{\text{in}} = 1 \text{ mW} \cdot 10^{4.9/10} = 3.09 \text{ mW}$
- $P_{\text{out}} = P_{\text{in}} / A_f = 3.09 \text{ mW} / 3.499 = 0.883 \text{ mW} = 883 \text{ } \mu\text{W}$

Limite putere/bandă a dispozitivelor optoelectronice

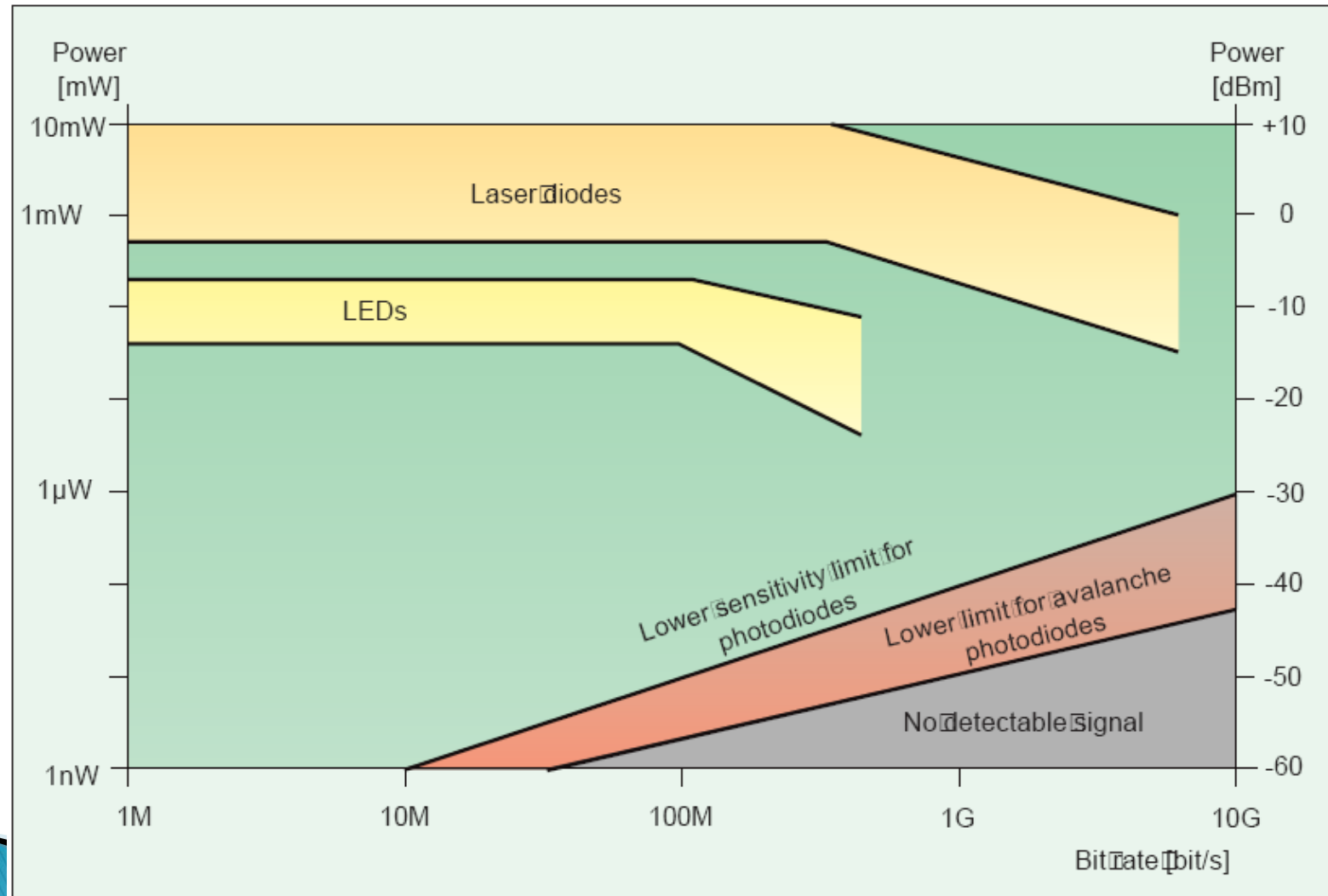

Contact

- ▶ Laboratorul de microunde si optoelectronica
- ▶ <http://rf-opto.etti.tuiasi.ro>
- ▶ rdamian@etti.tuiasi.ro