

Optoelectronică, structuri și tehnologii

Curs 7
2011/2012

Fibra optică

Capitolul 5

Recapitulare

Fibre

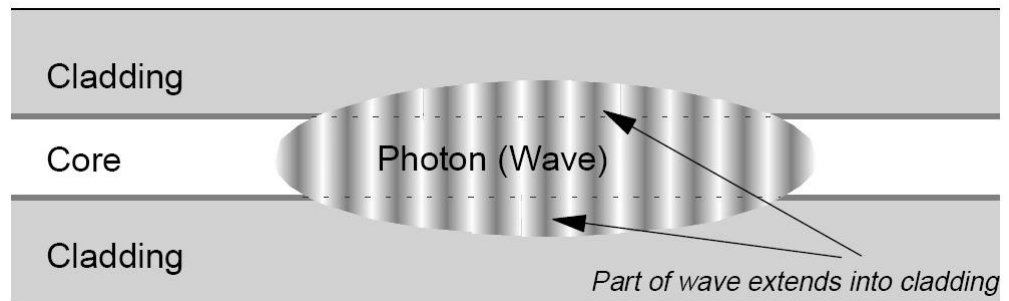
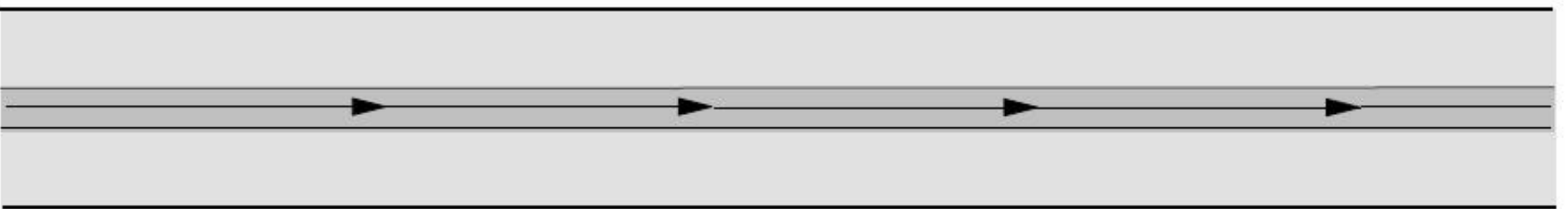
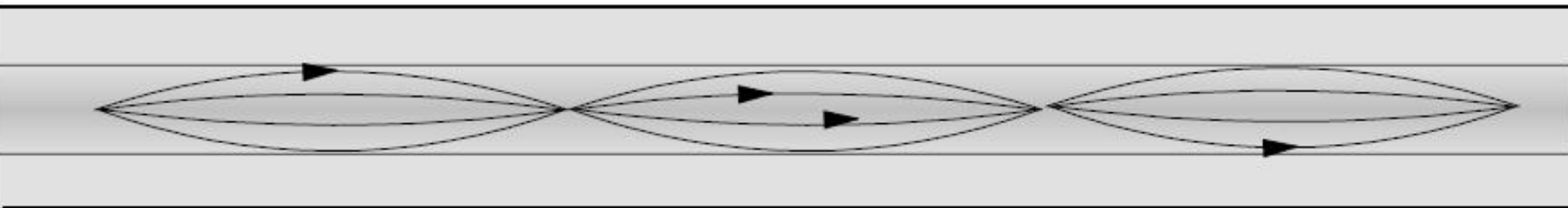
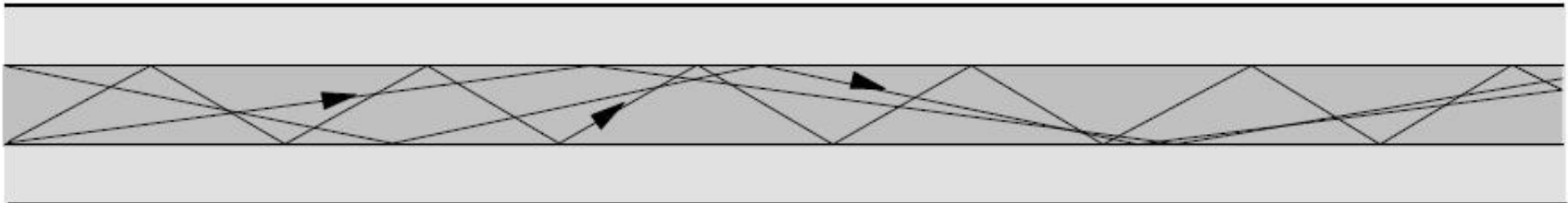

Dispersia

- ▶ intermodala (modala – depinde de prezenta modurilor)
- ▶ intramodala (cromatica – depinde de lungimea de unda)
 - de material
 - de ghid

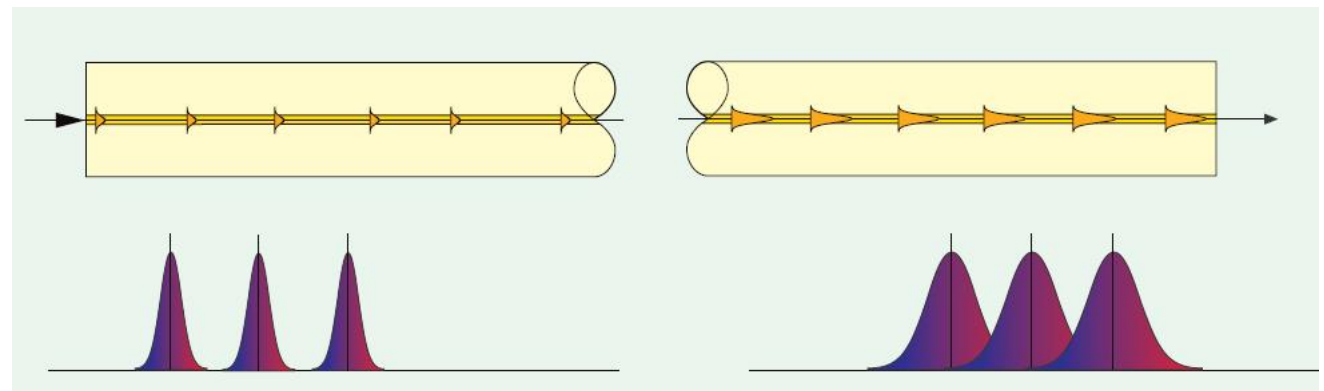

Dispersia de material

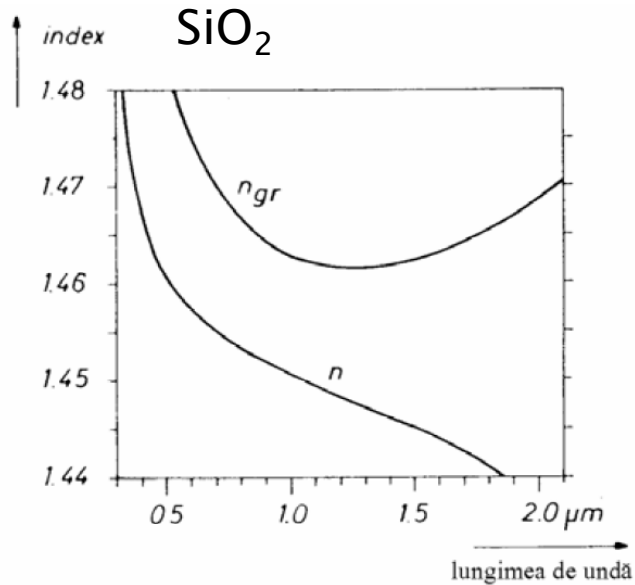

$$n_{gr} = n - \lambda \frac{dn}{d\lambda}$$

$$\Delta\tau_{mat} = \frac{L \cdot \lambda \cdot \Delta\lambda}{c} \cdot \frac{d^2n}{d\lambda^2}$$

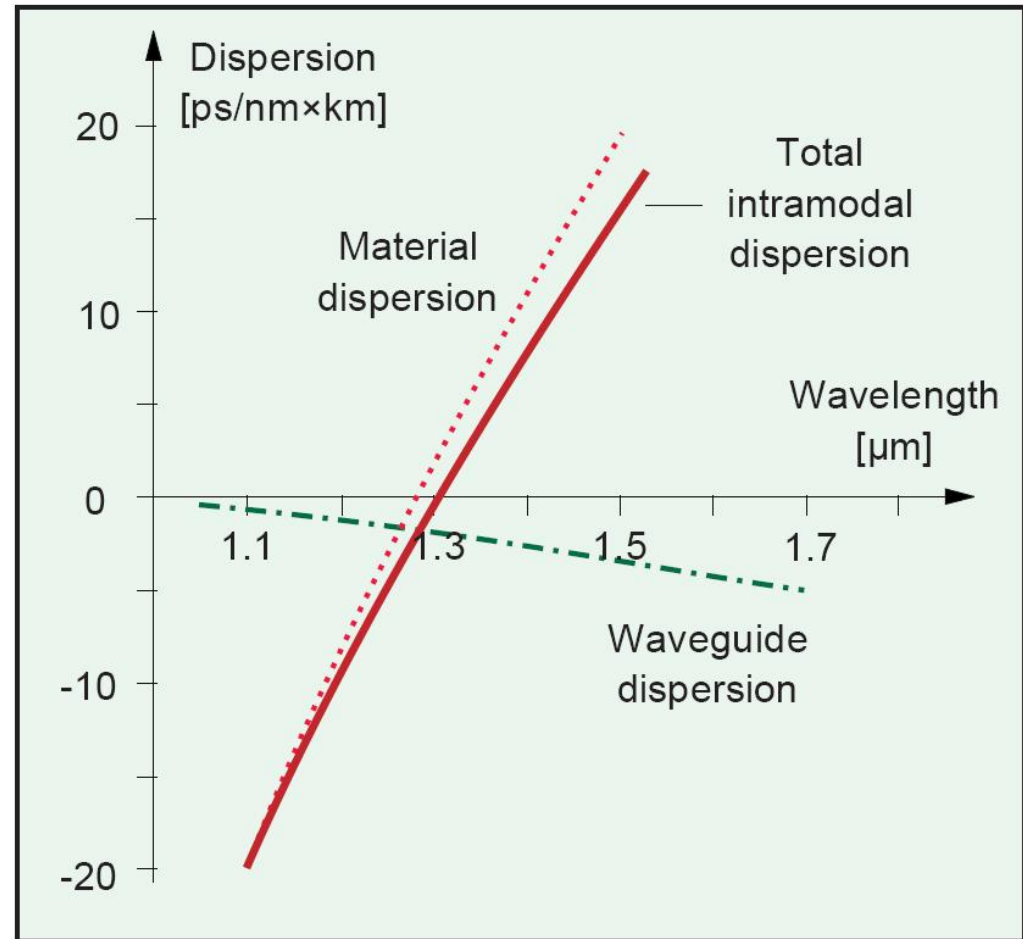

Dispersia cromatica

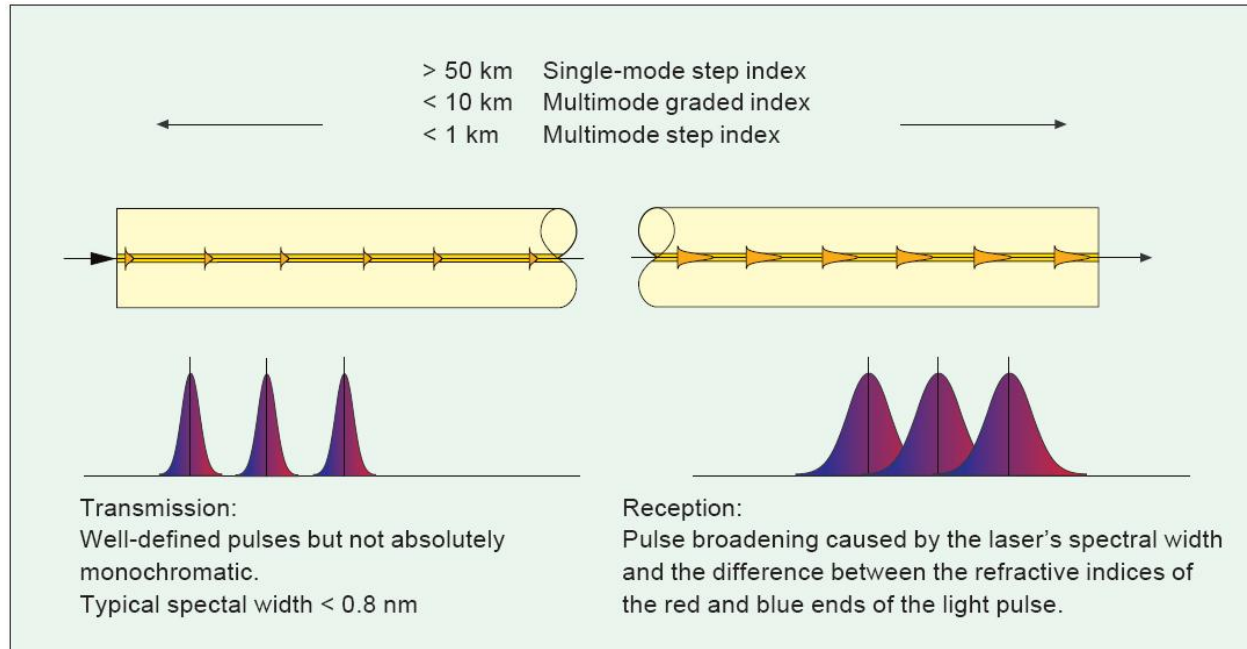

$$\Delta\tau_{cr} = D(\lambda) \cdot \Delta\lambda \cdot L$$

$$D(\lambda) = \frac{S_0}{4} \cdot \left(\lambda - \frac{\lambda_0^4}{\lambda^3} \right)$$

S_0 panta dispersiei -
ps/nm²/km

- ▶ $D(\lambda) \approx 100 + 0.4 (850 - \lambda)$ [ps/nm/km]
pentru $800 < \lambda < 900$ nm
- ▶ $D(\lambda) \leq 3,5$ ps/nm/km
pentru $1285 < \lambda < 1330$ nm
- ▶ $D(\lambda) \leq 17$ ps/nm/km
pentru $1525 < \lambda < 1575$ nm

$$D(\lambda) = \frac{S_0}{4} \cdot \left(\lambda - \frac{\lambda_0^4}{\lambda^3} \right)$$

Calitatea spectrală a emițătorilor optici

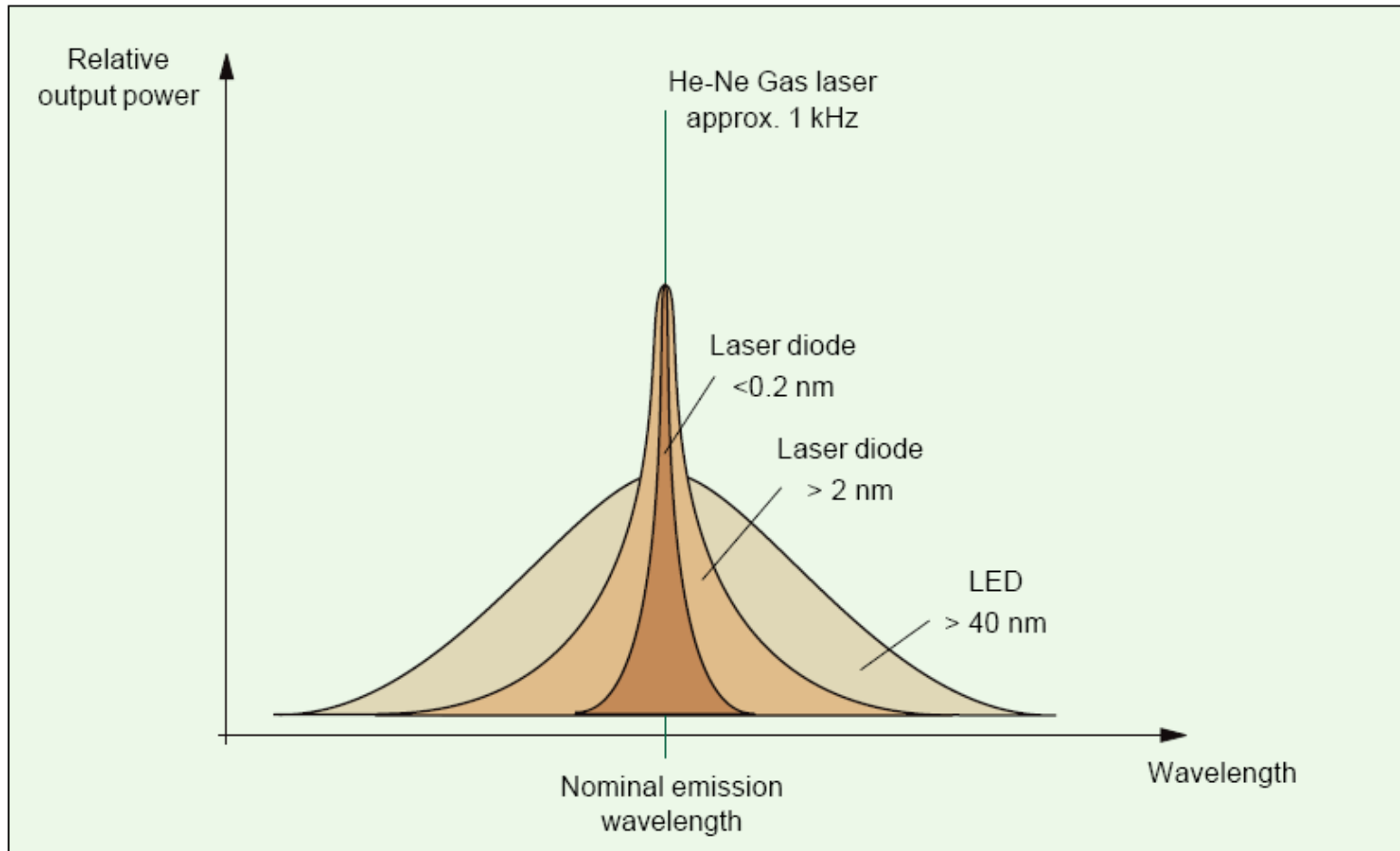

He-Ne Laser

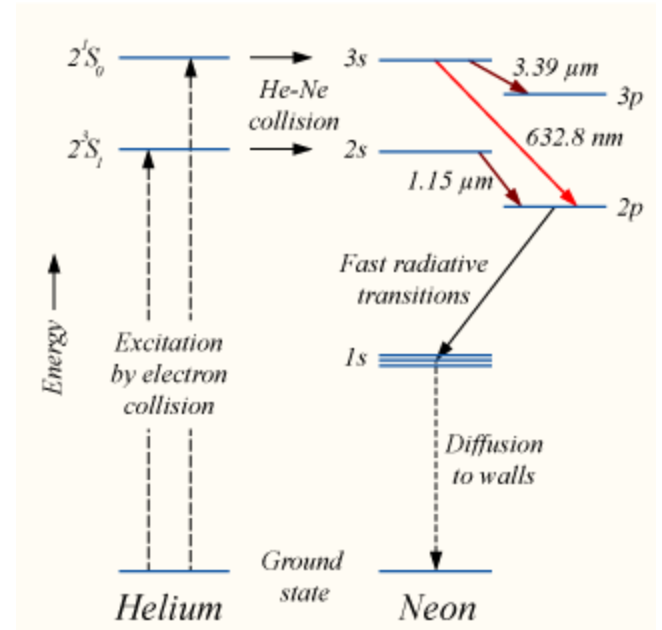
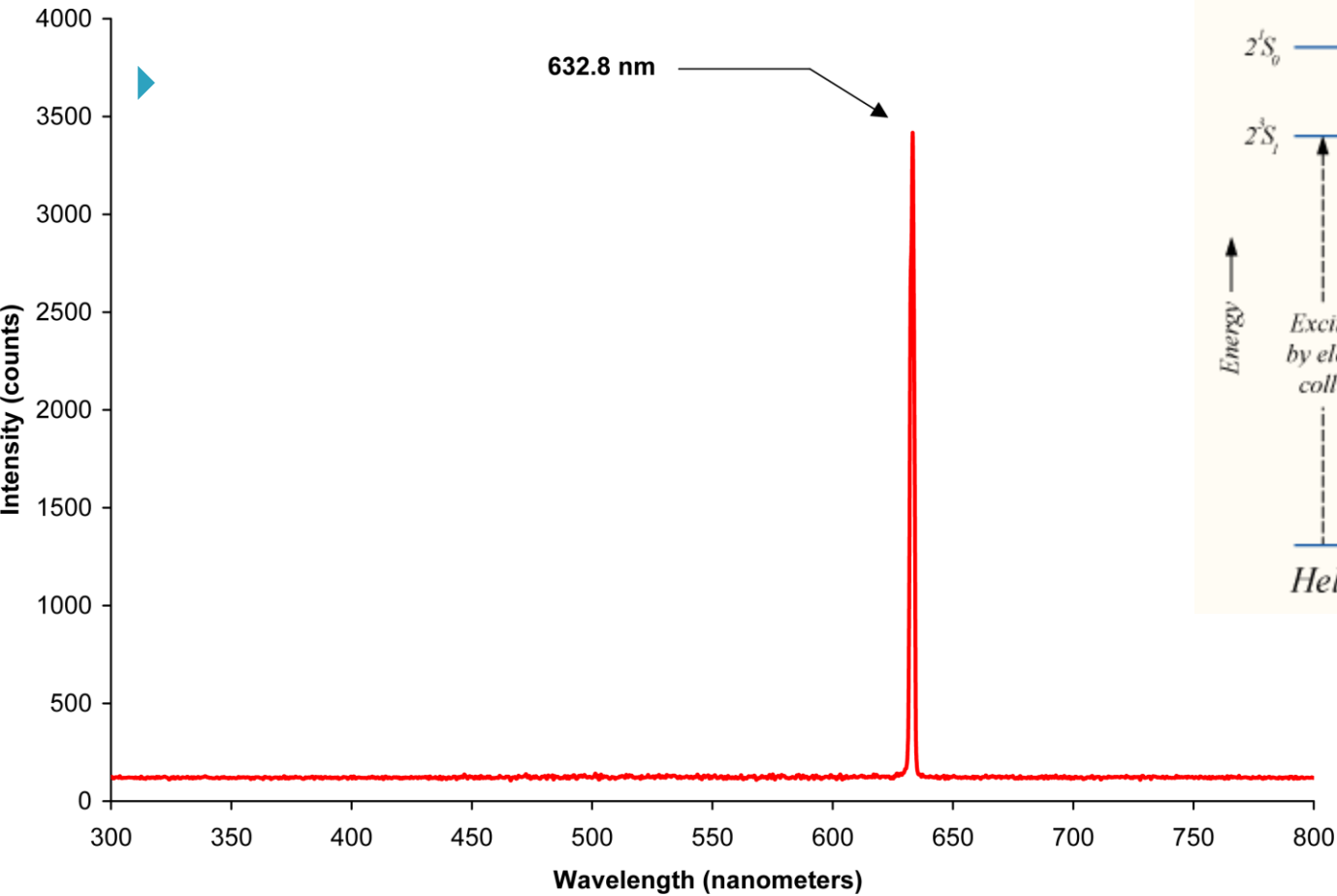

$$\Delta\lambda = 0.002 \text{ nm}$$

Non-zero Dispersion shifted fibers

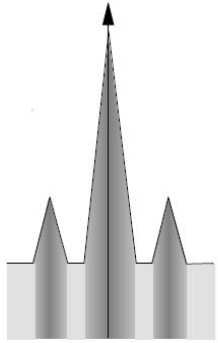

FWM

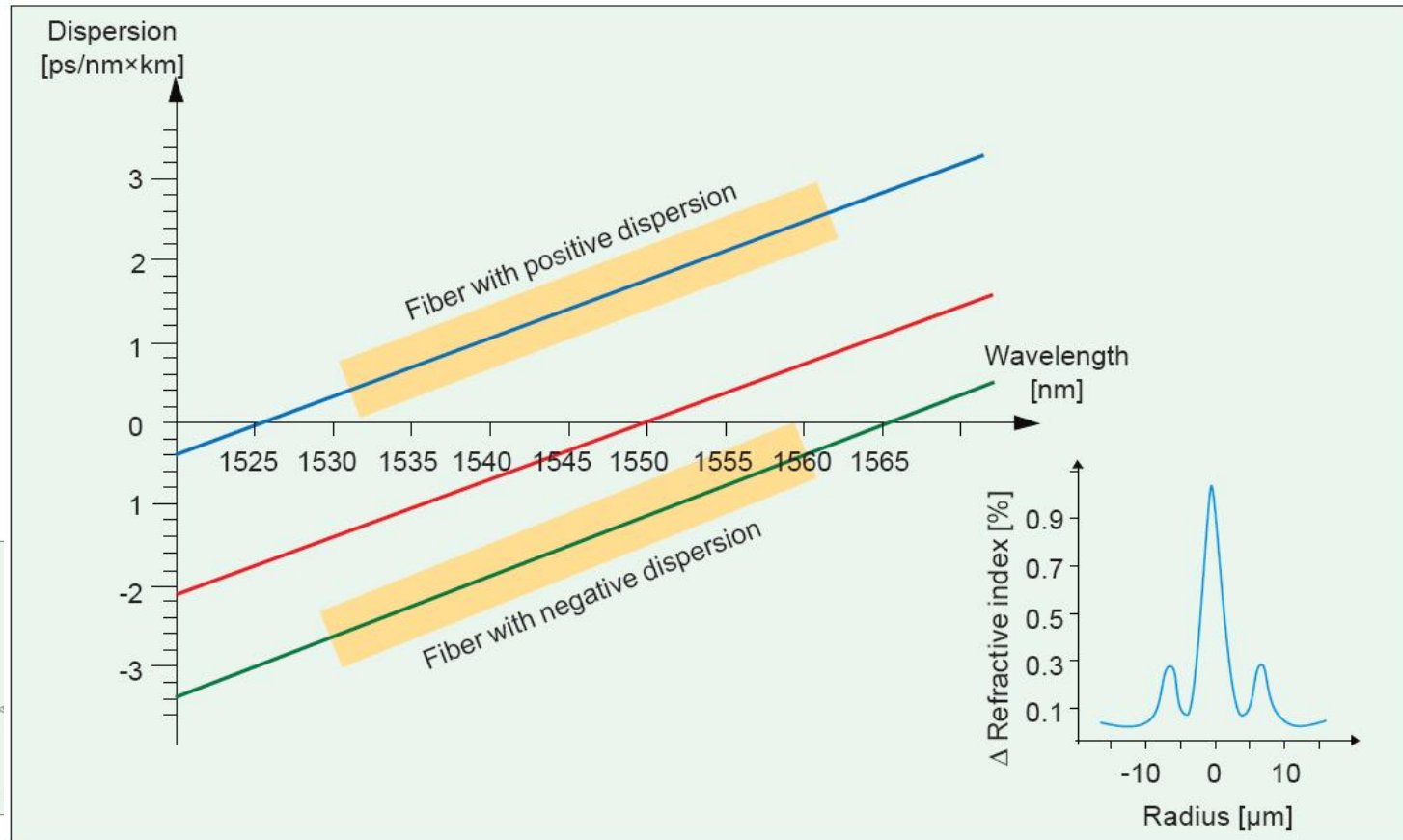
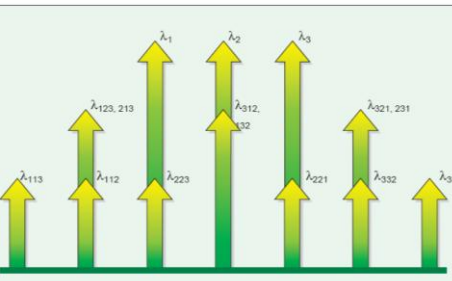

ATENUAREA

- ▶ Macrocurburi
- ▶ Microcurburi
- ▶ Imprastiere
- ▶ Absorbție

$$\text{Pierderi} = \frac{P_{out}}{P_{in}}$$

$$\text{Pierderi [dB]} = [-] 10 \cdot \log_{10} \left(\frac{P_{out}}{P_{in}} \right)$$

$$\text{Atenuare [dB/km]} = \frac{\text{Pierderi [dB]}}{\text{lungime [km]}}$$

Fibra optică – Tehnologie

Capitolul 6

OTDR

- ▶ Optical time-domain reflectometer
- ▶ Localizarea defectelor

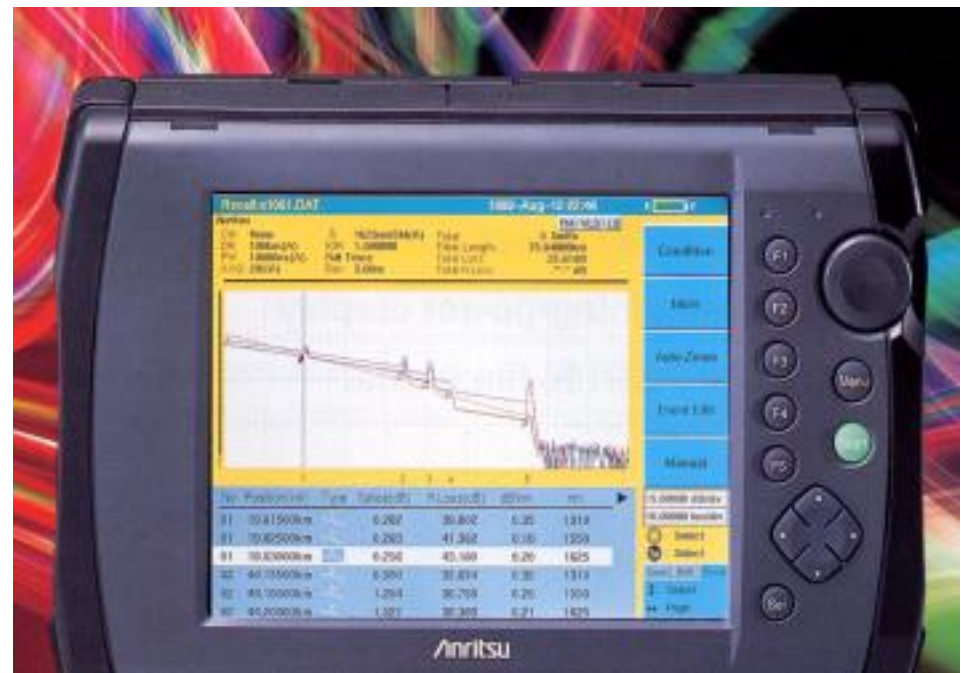
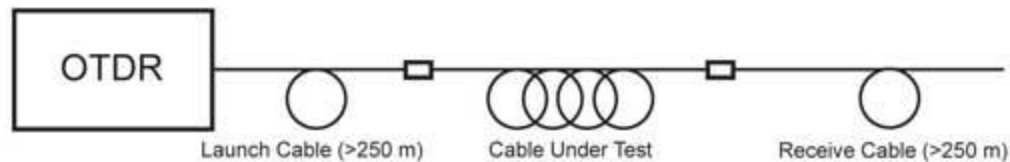

Rezultat grafic al OTDR

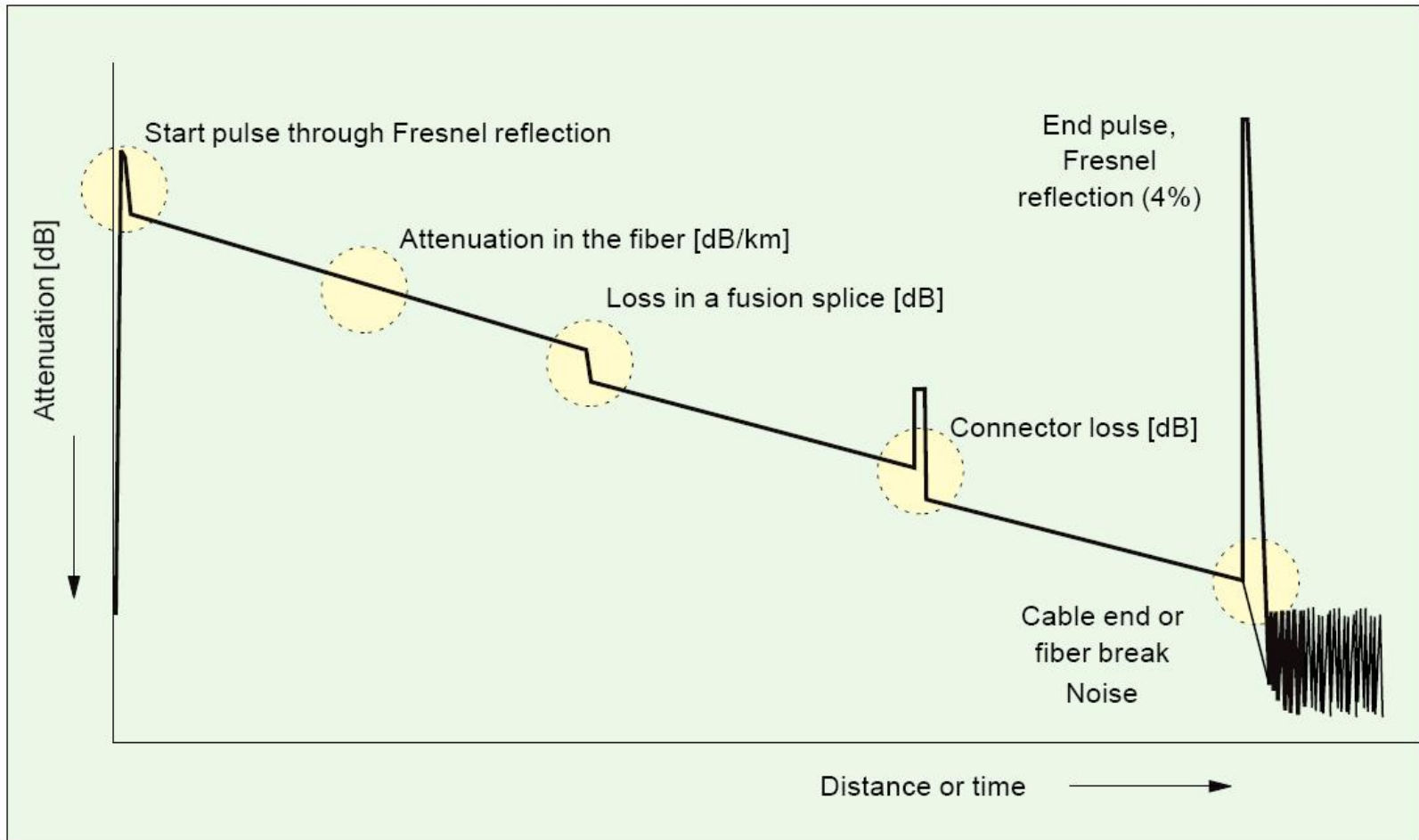

Efecte vizibile OTDR

reflections show OTDR pulse width and resolution

connectors show both loss and reflections

splices are usually not reflective

slope of trace shows fiber attenuation coefficient

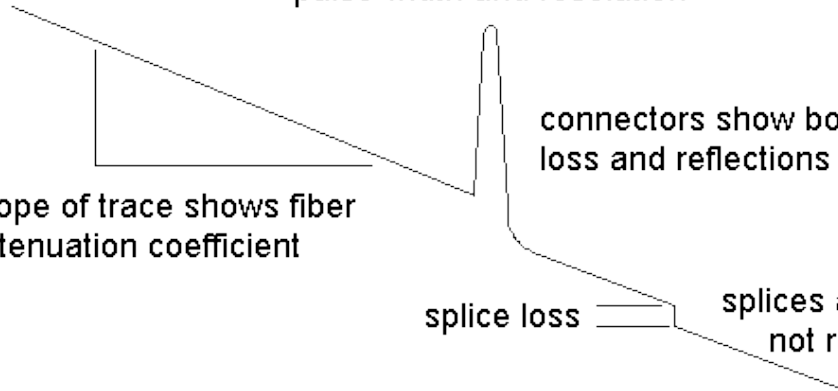

a. same fiber spliced

error caused by fiber characteristics

b. high loss fiber spliced to low loss fiber

error caused by fiber characteristics

c. low loss fiber spliced to high loss fiber can cause an apparent gain at a splice

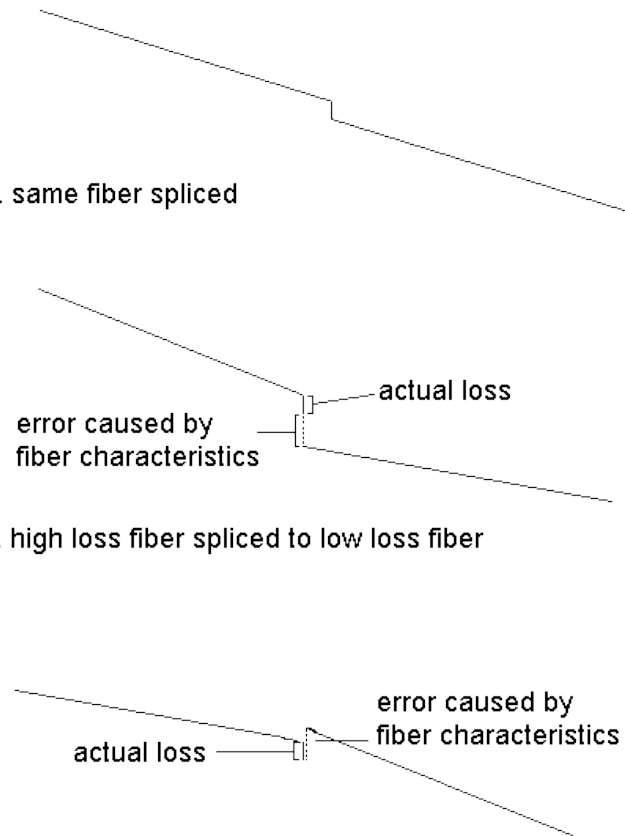

$$Splice\ loss = \frac{Splice\ loss_{A \rightarrow B} + Splice\ loss_{B \rightarrow A}}{2}$$

Stabilized light source

Optical power meter

► Masurarea puterii si atenuarii

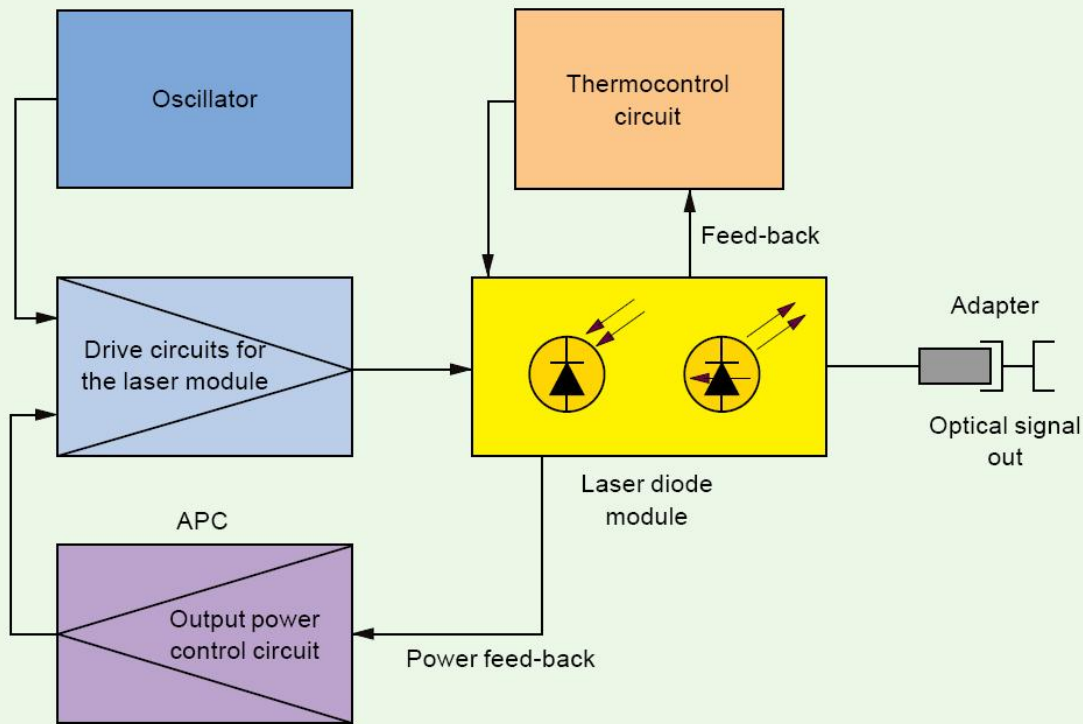

Taiere – Cleaving

- ▶ Tehnici necesare pentru a asigura o taiere perpendiculara pe axa fibrei

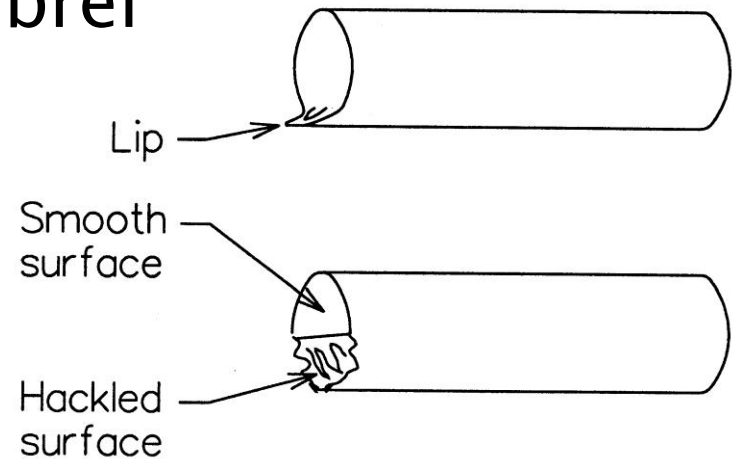
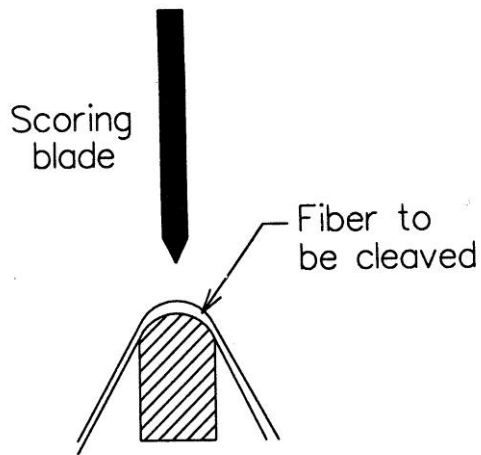

Lipire prin fuziune



Splice prin fuziune

Fibers Stripped of Coating, Cleaned, and Cleaved, are Brought Together During the Fusion Arc

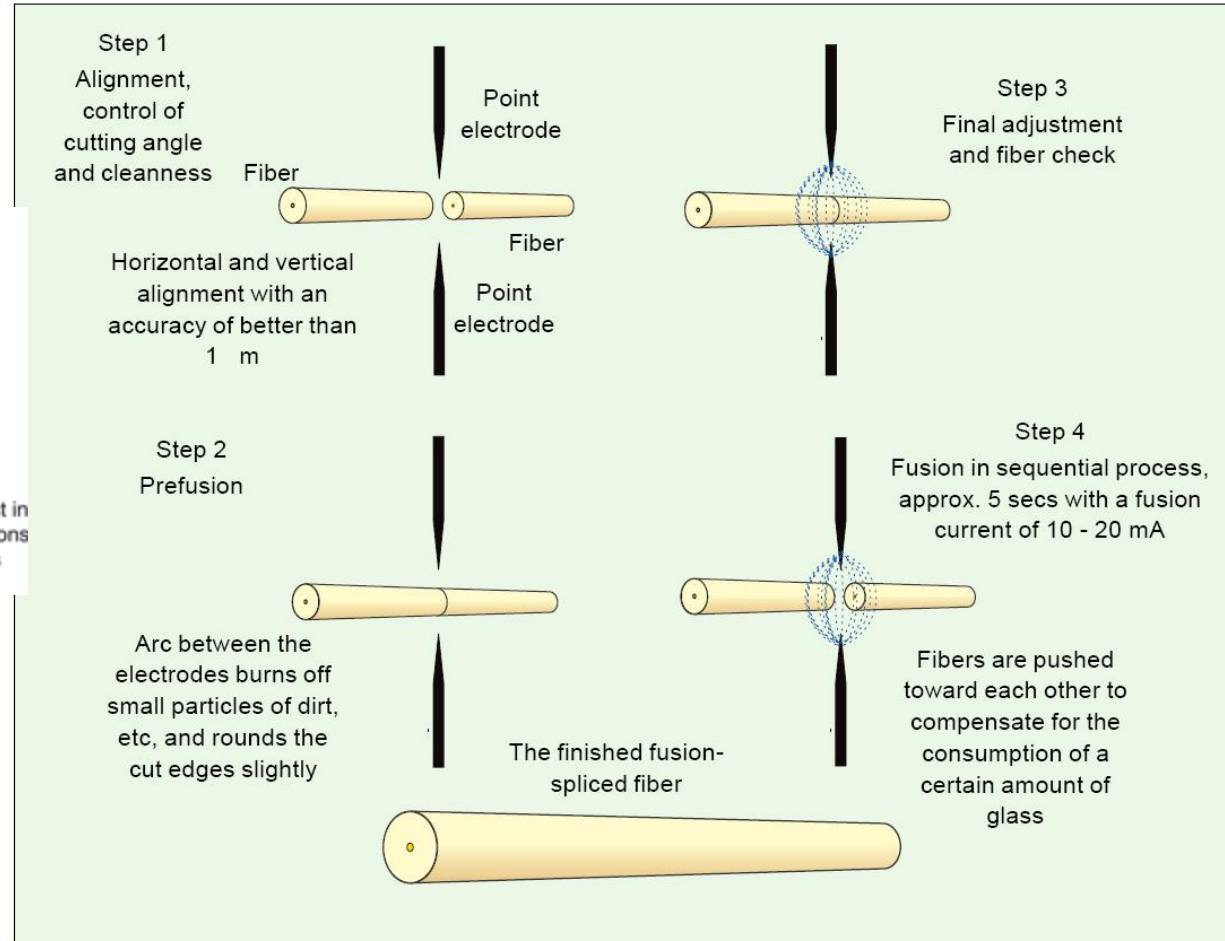
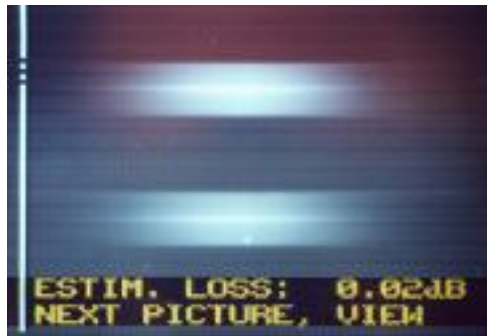
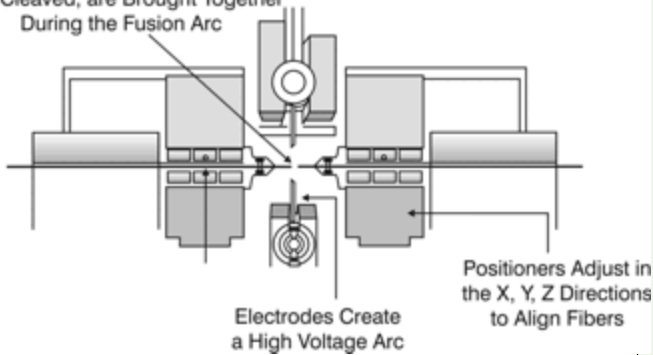

Splice prin fuziune

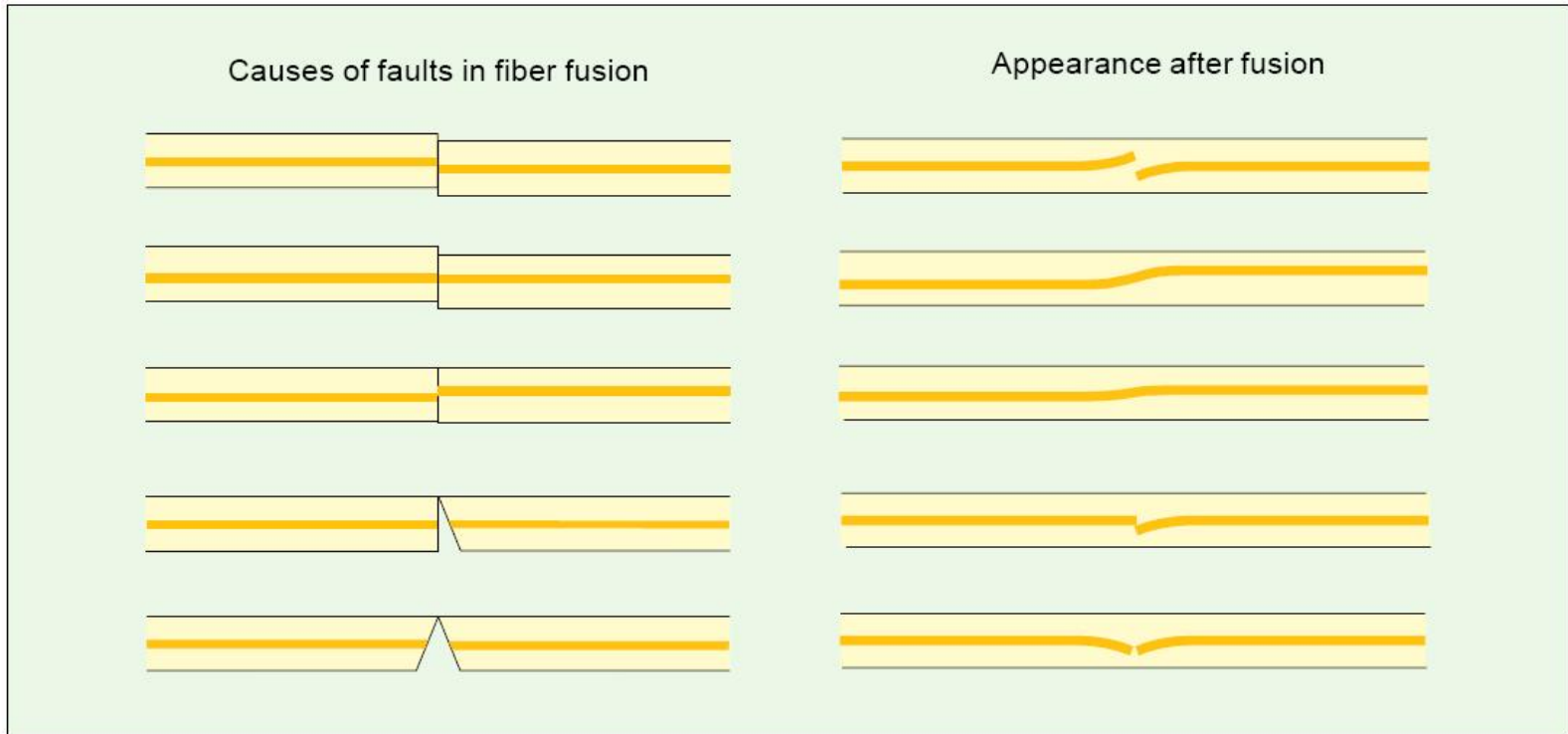

Splice mechanic – bloc V

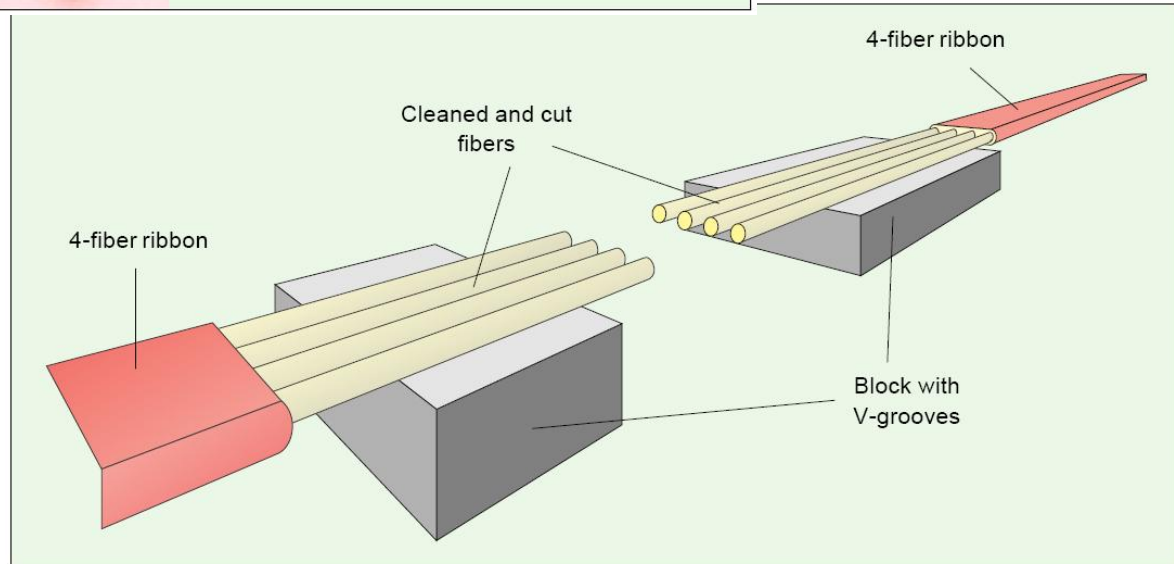
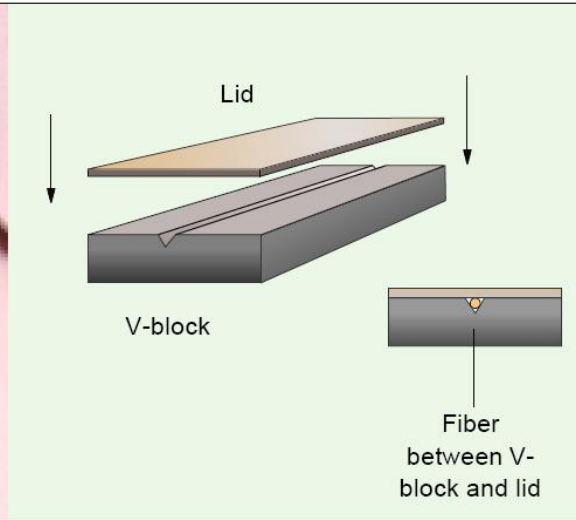
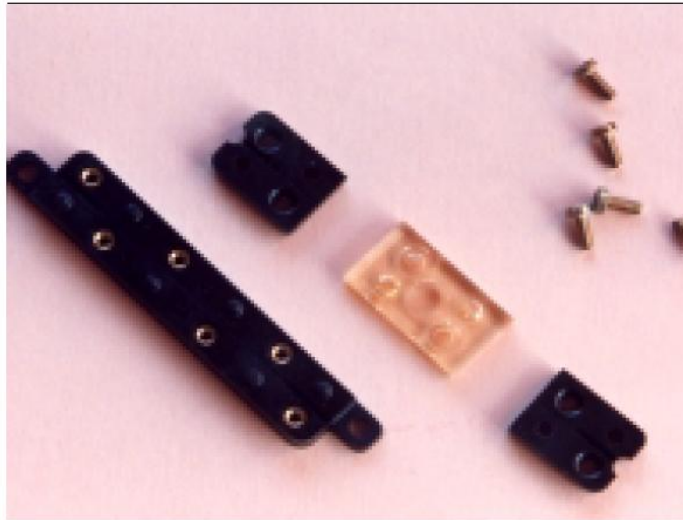

Splice mechanic - bloc V

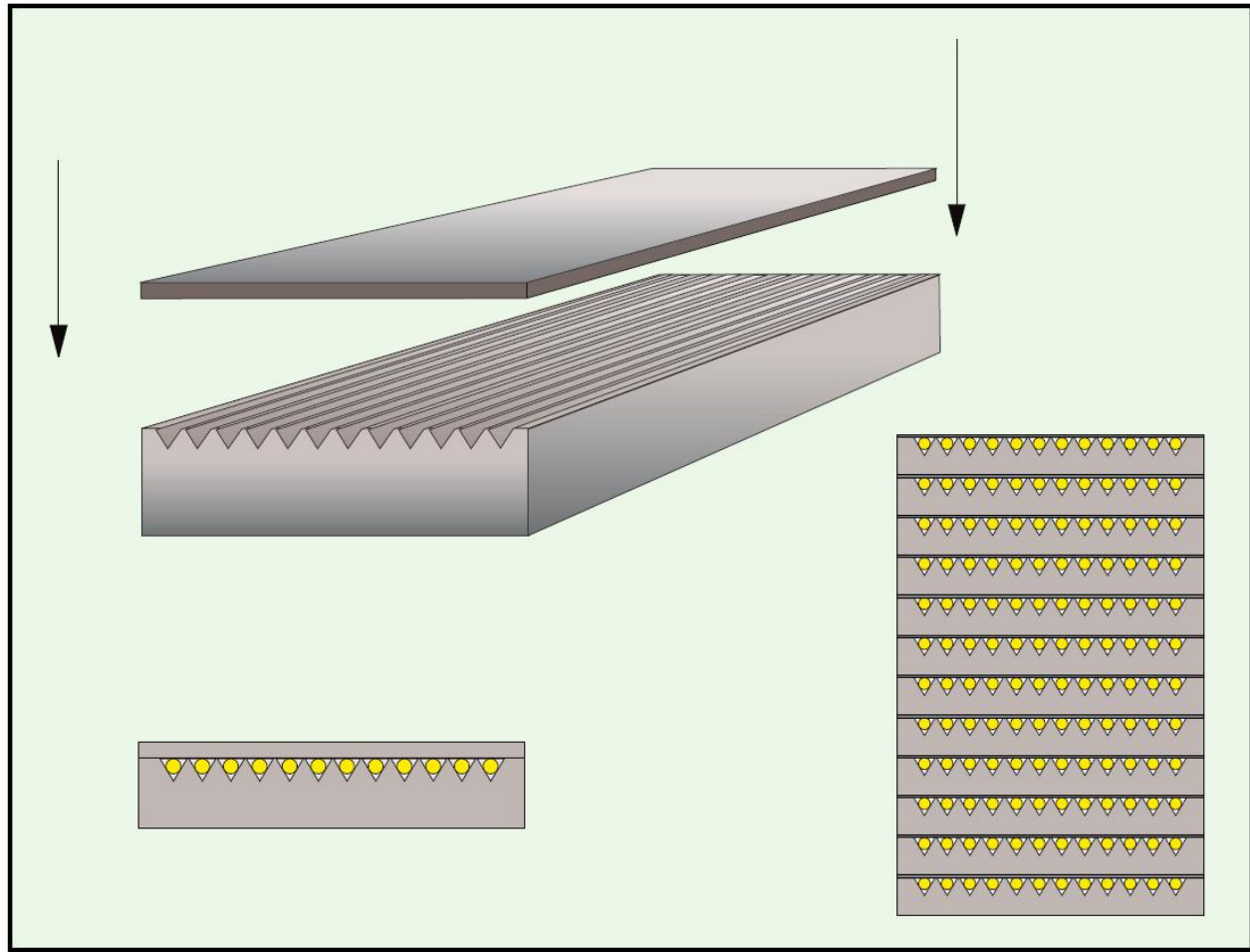

Splice mechanic

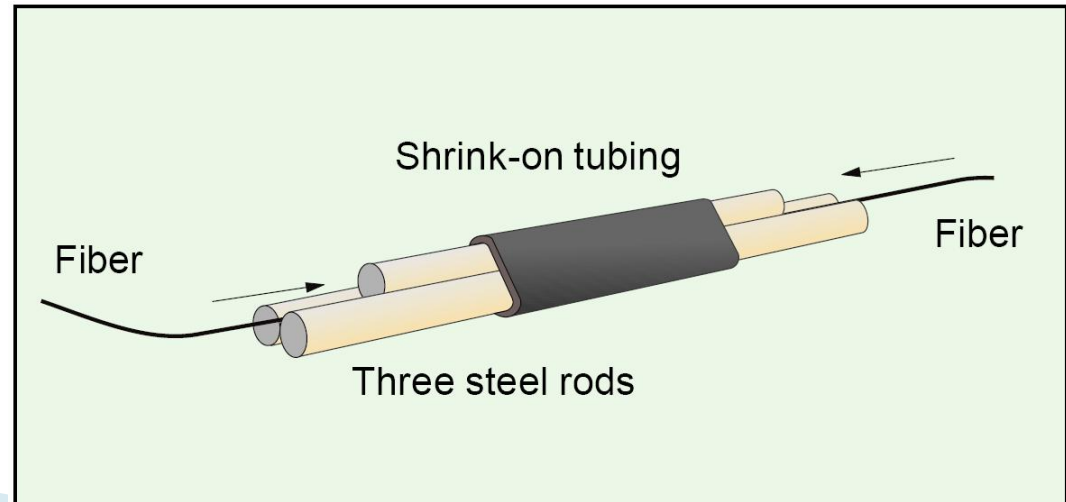
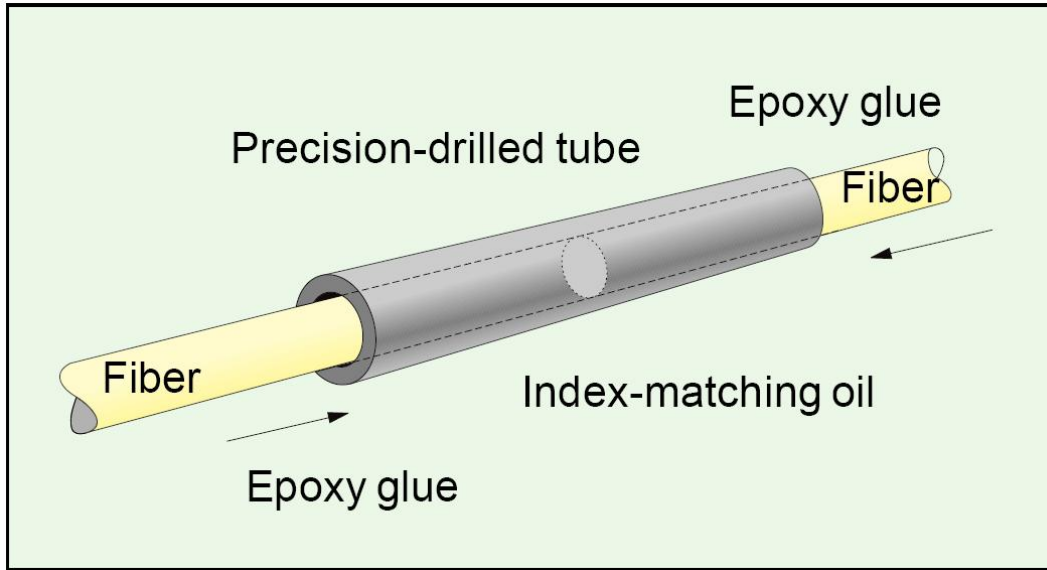

Probleme Fibre/Conectori

Offset

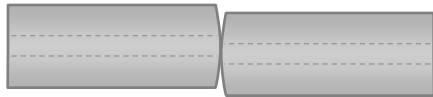

Angular Misalignment

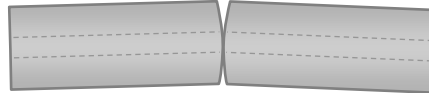

Separation



Core Eccentricity

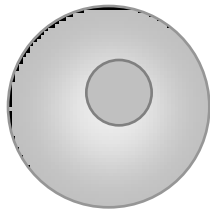

Core Ellipticity

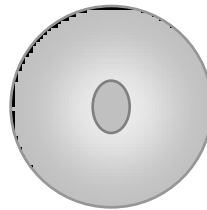

Reflections & Interference

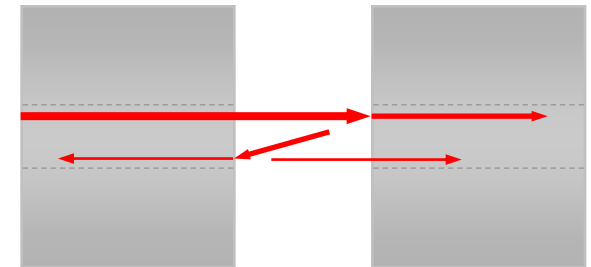

Cabluri

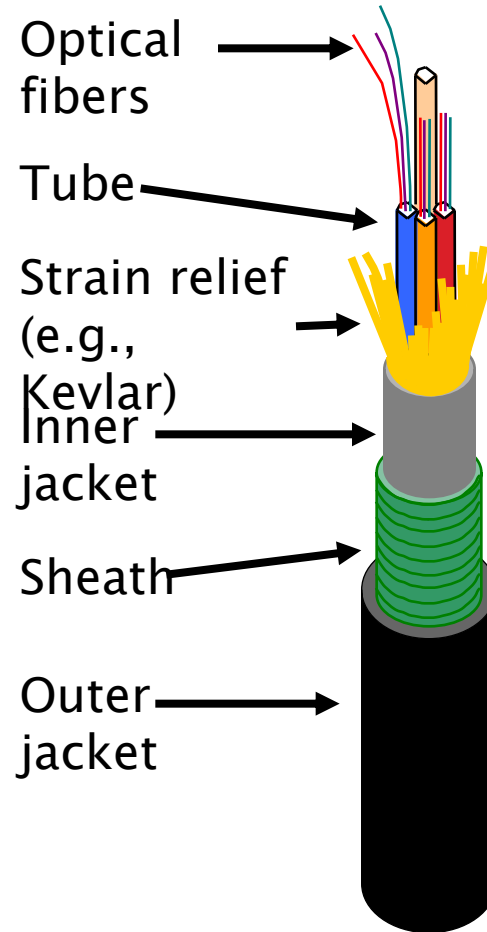
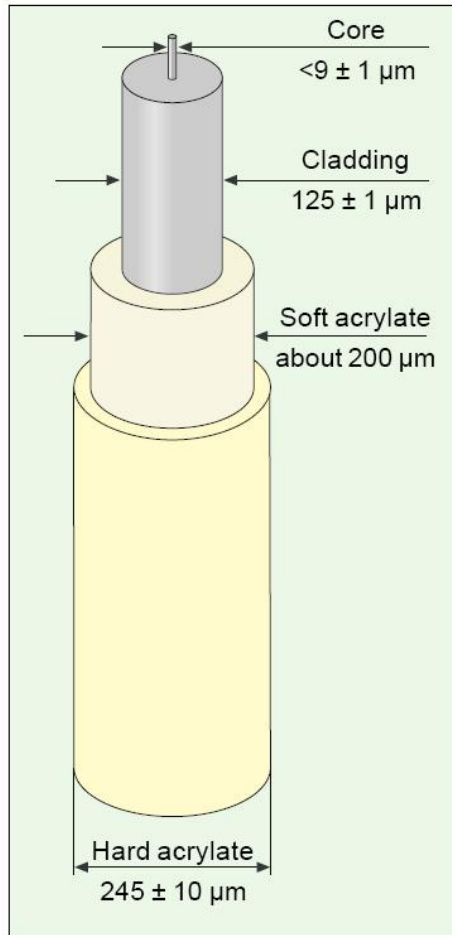

Cabluri

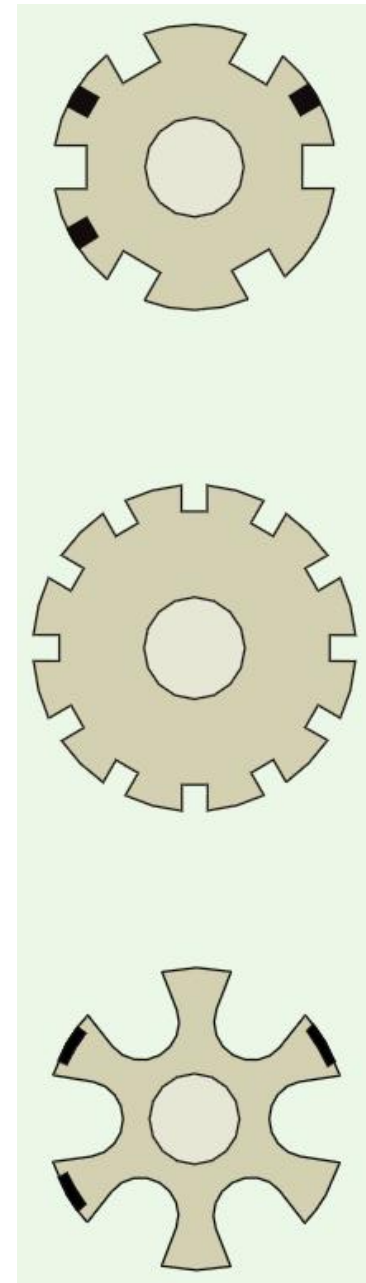
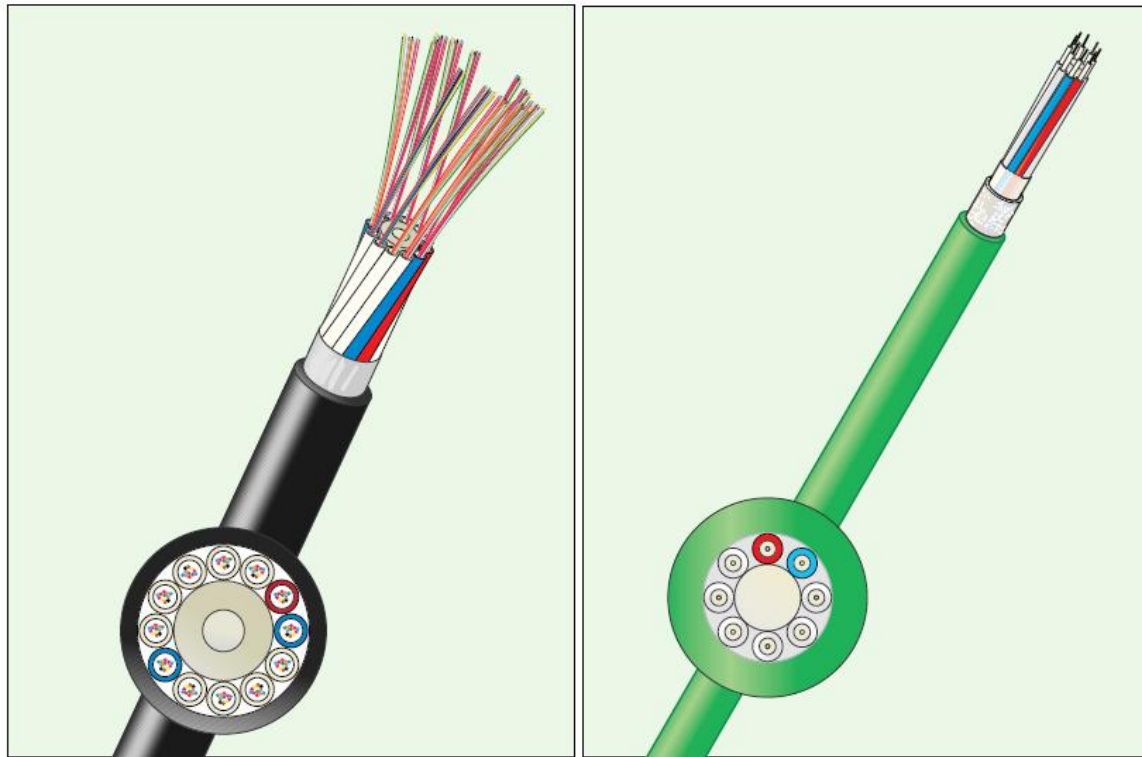

Cabluri

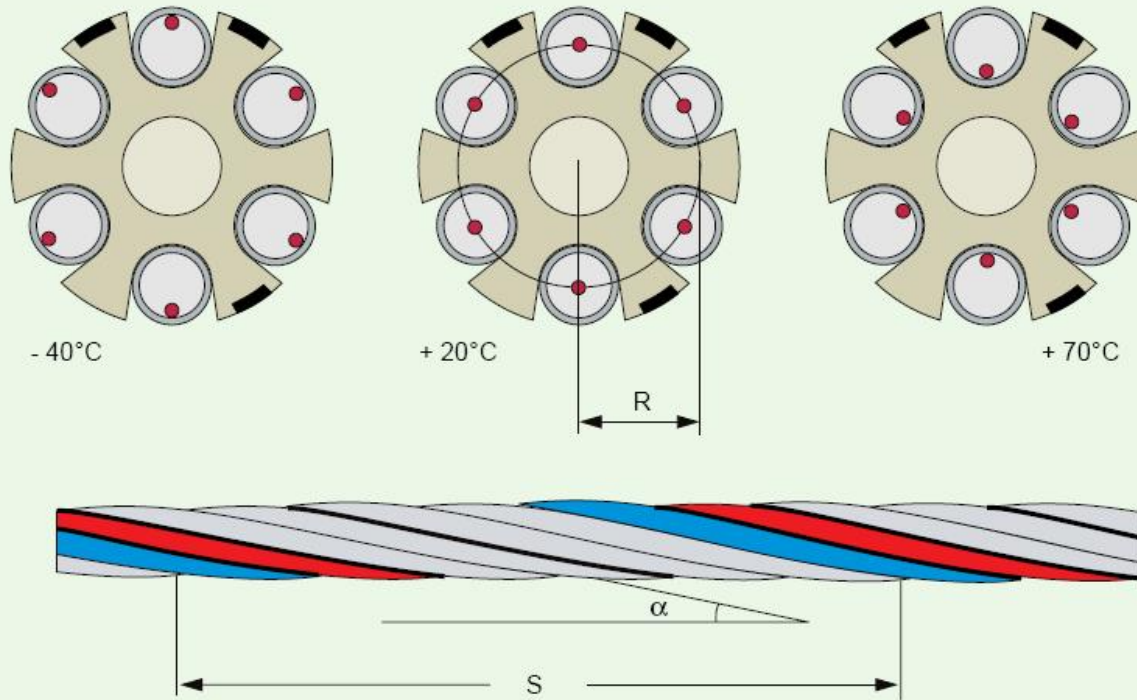

$$L = S \sqrt{1 + \left(\frac{2\pi R}{S} \right)^2}$$

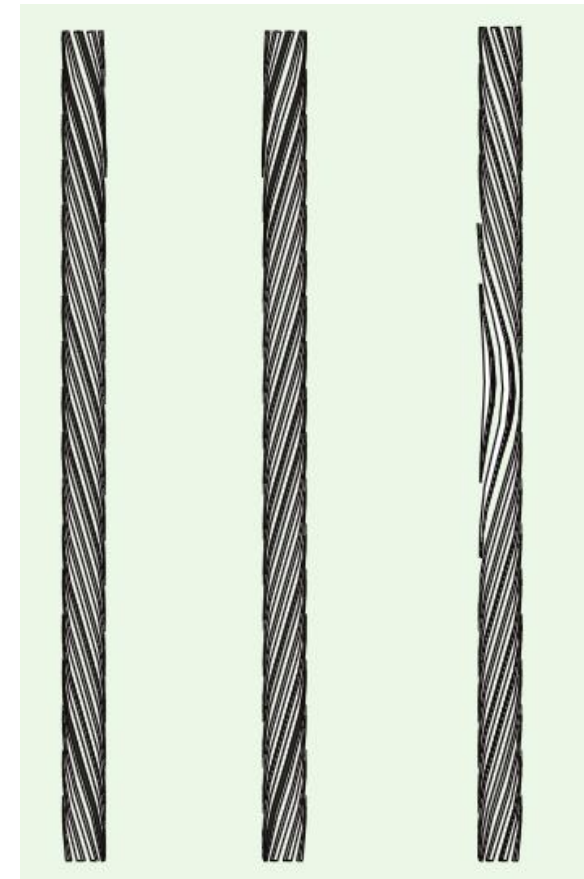

Cabluri

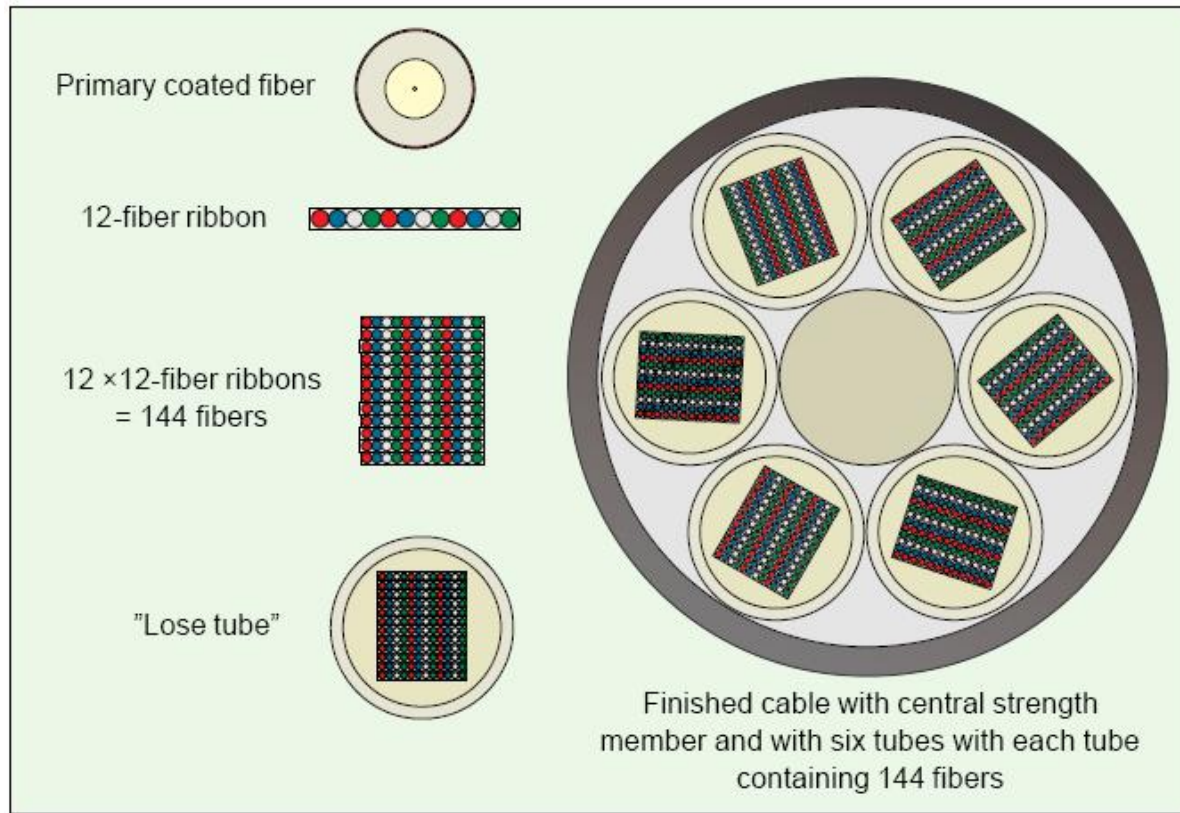
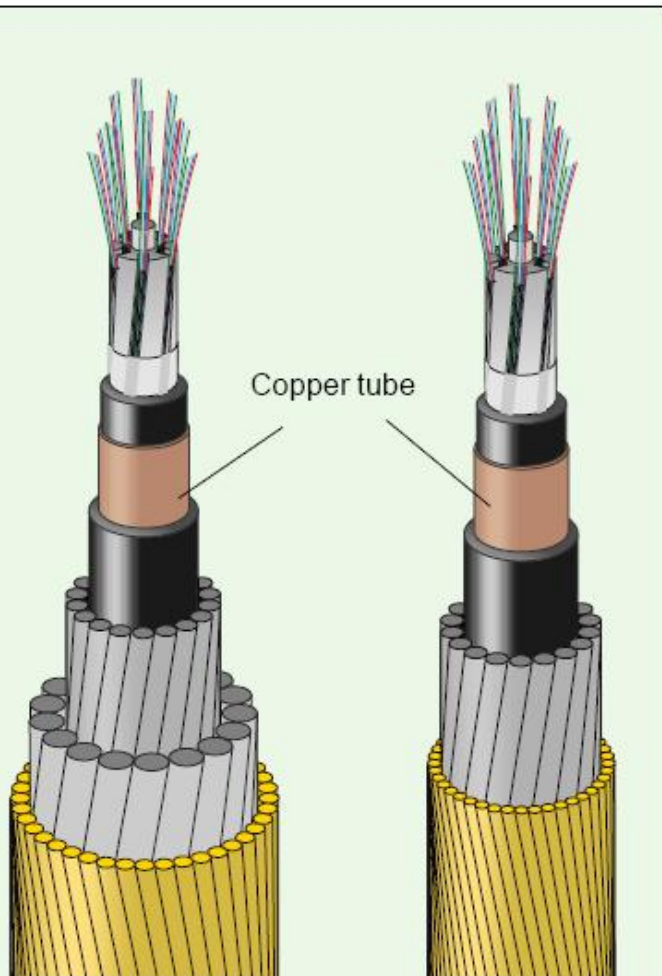

Conettori

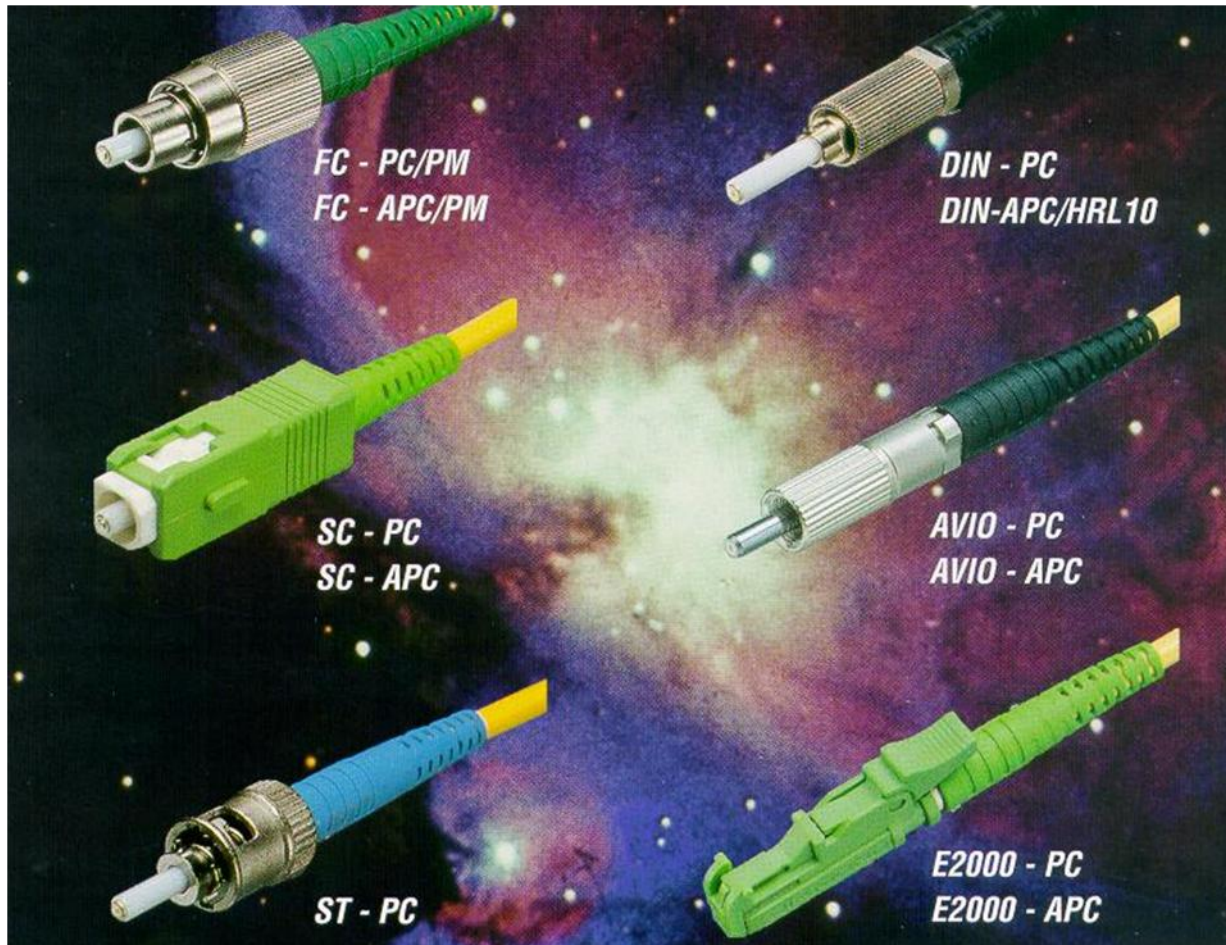

Conettori

- ▶ Verificati <http://rf-opto.etc.tuiasi.ro>

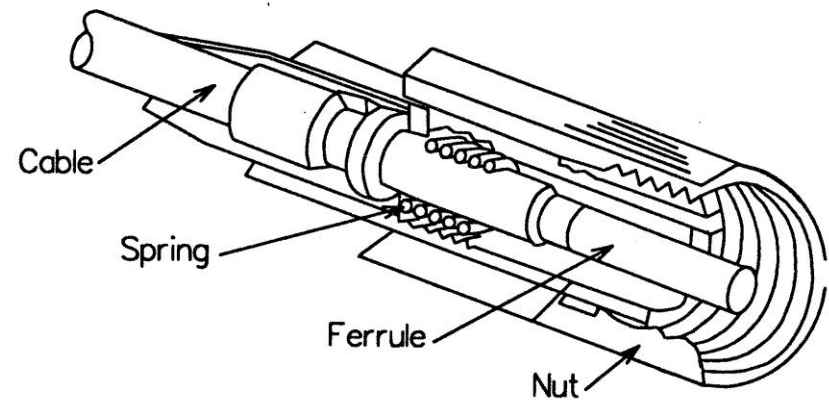
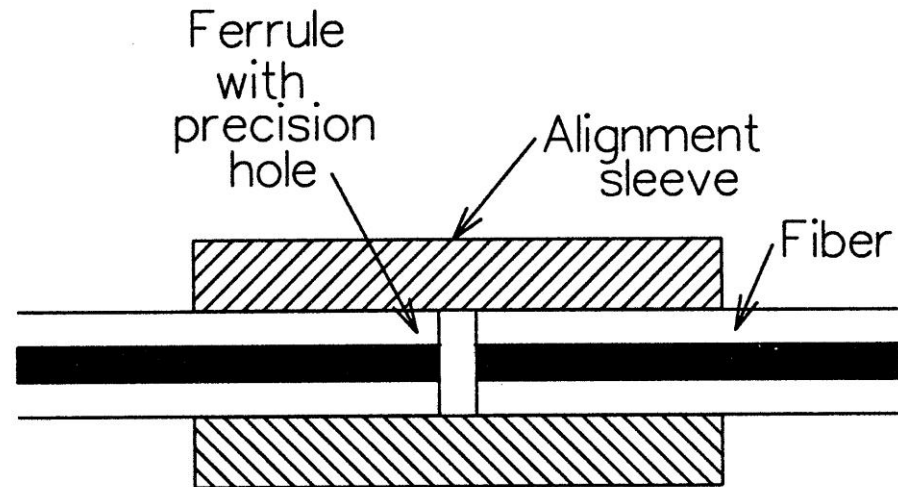
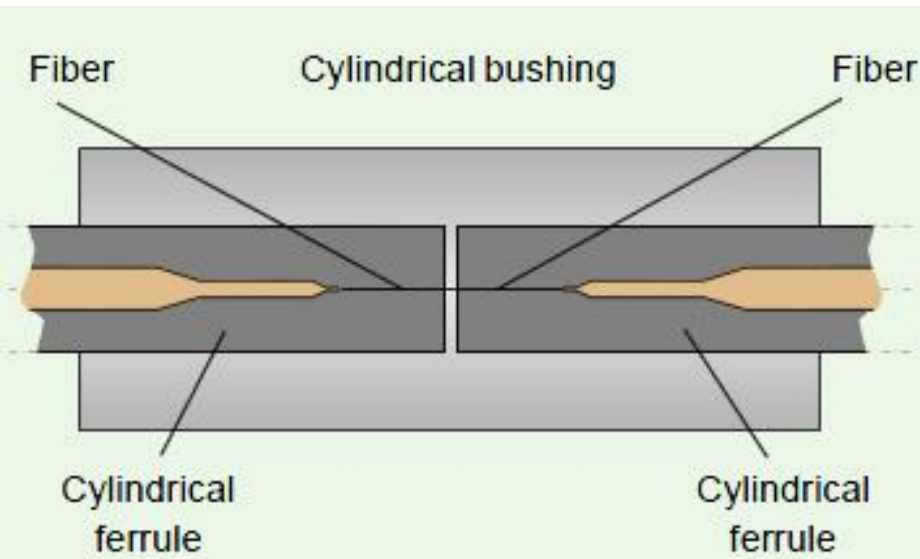

Dimensionarea unei legături pe fibra optică

Capitolul 7



Limite putere/bandă a dispozitivelor optoelectronice

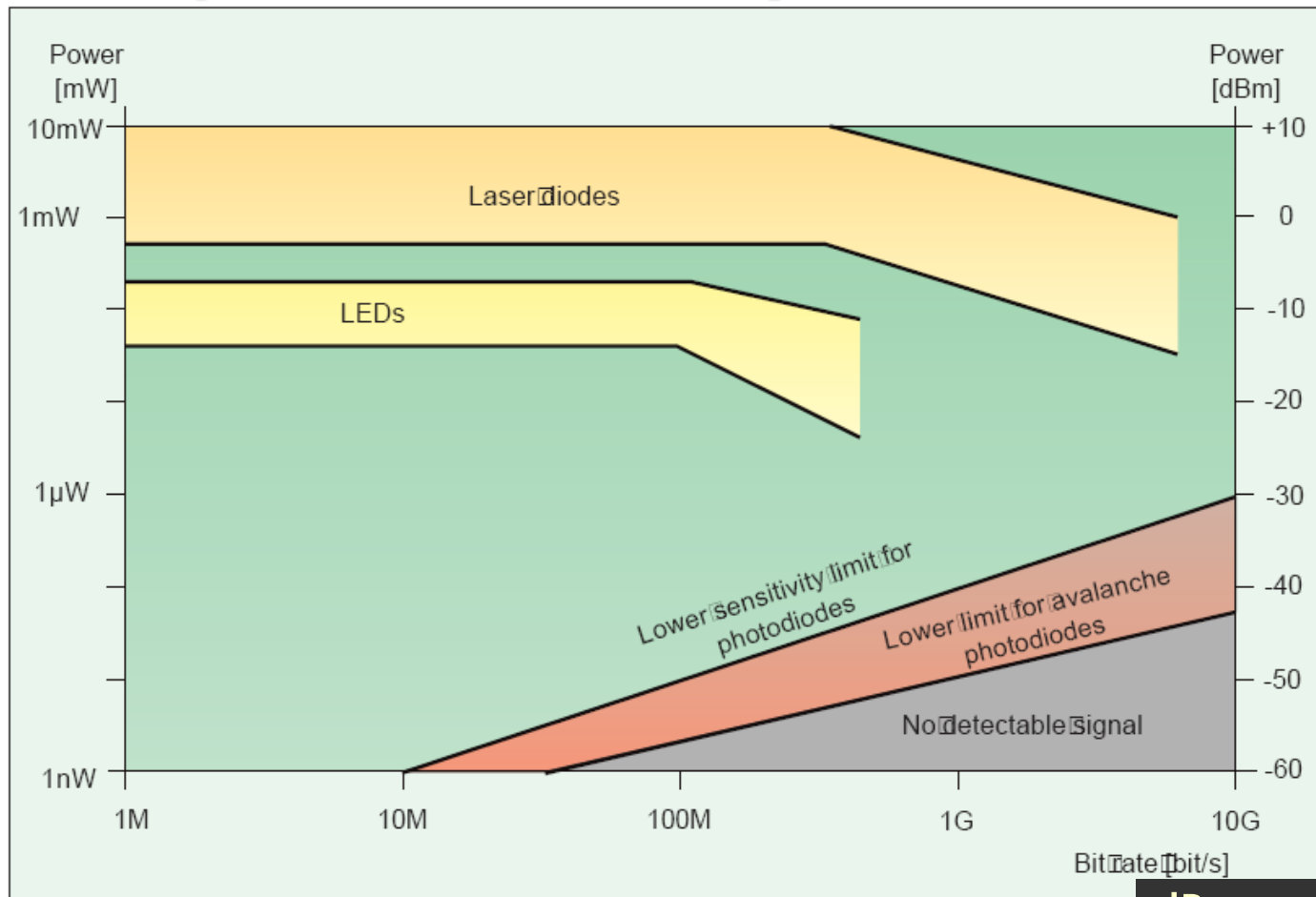

$$\text{dB} = 10 \cdot \log_{10} (P_2 / P_1)$$

$$\text{dBm} = 10 \cdot \log_{10} (P / 1 \text{ mW})$$

$$[\text{dBm}] + [\text{dB}] = [\text{dBm}]$$

Legatura pe fibra optica

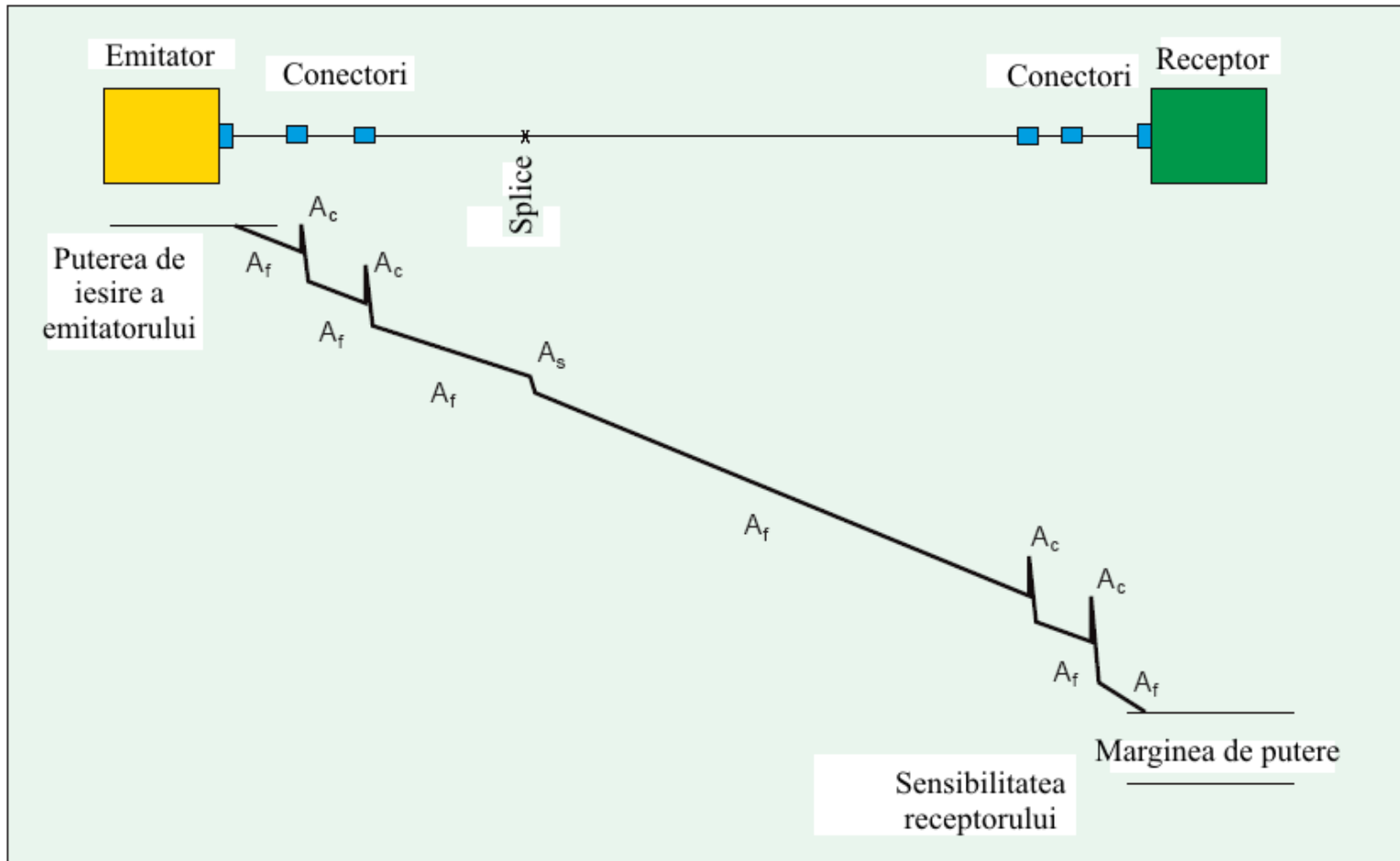

Pierderi – Apertura numerica

- ▶ **Numai** la trecerea de la apertura numerica mai mare la apertura numerica mai mica

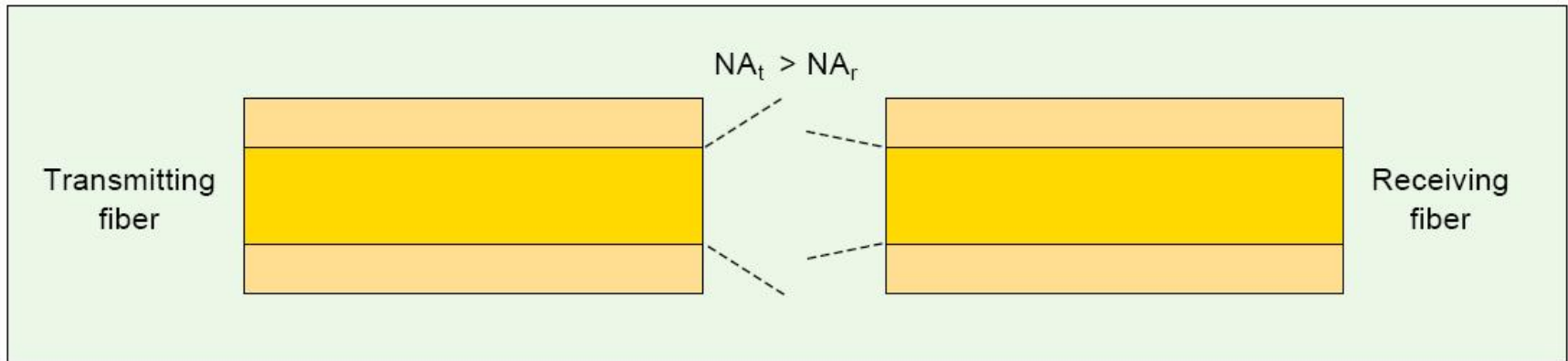

$$\text{Attenuation}_{NA} = 10 \log_{10} \left(\frac{NA_r}{NA_t} \right)^2$$

Pierderi – Diametrul miezului

- ▶ **Numai** la trecerea de la diametru mai mare la diametru mai mic

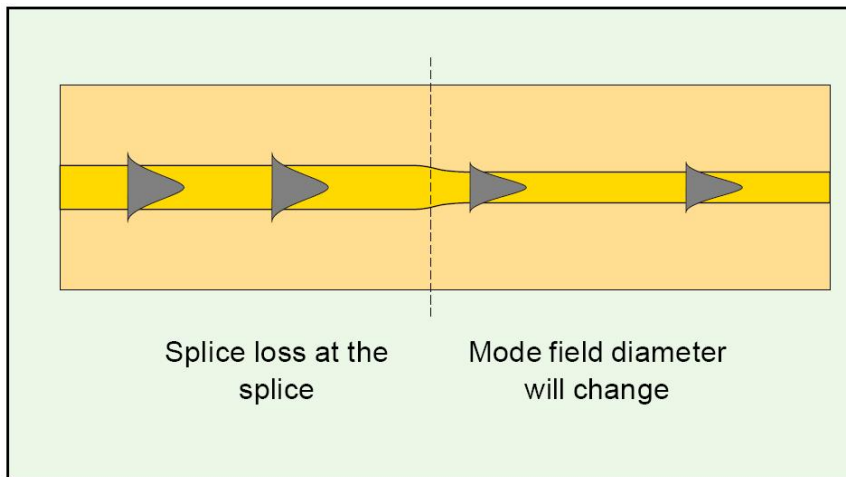

$$\text{Attenuation}_{\varnothing} (\text{multimode}) = -10 \log_{10} \left(\frac{\varnothing_r}{\varnothing_t} \right)^2$$

$$\text{Attenuation}_{\varnothing} (\text{single-mode}) = -20 \log \left(\frac{2 w_1 w_2}{w_1^2 + w_2^2} \right)$$

Pierderi – Nealinierarea axelor

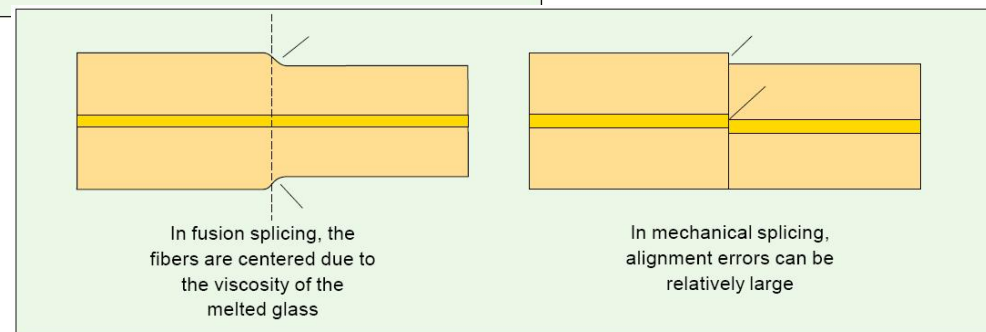
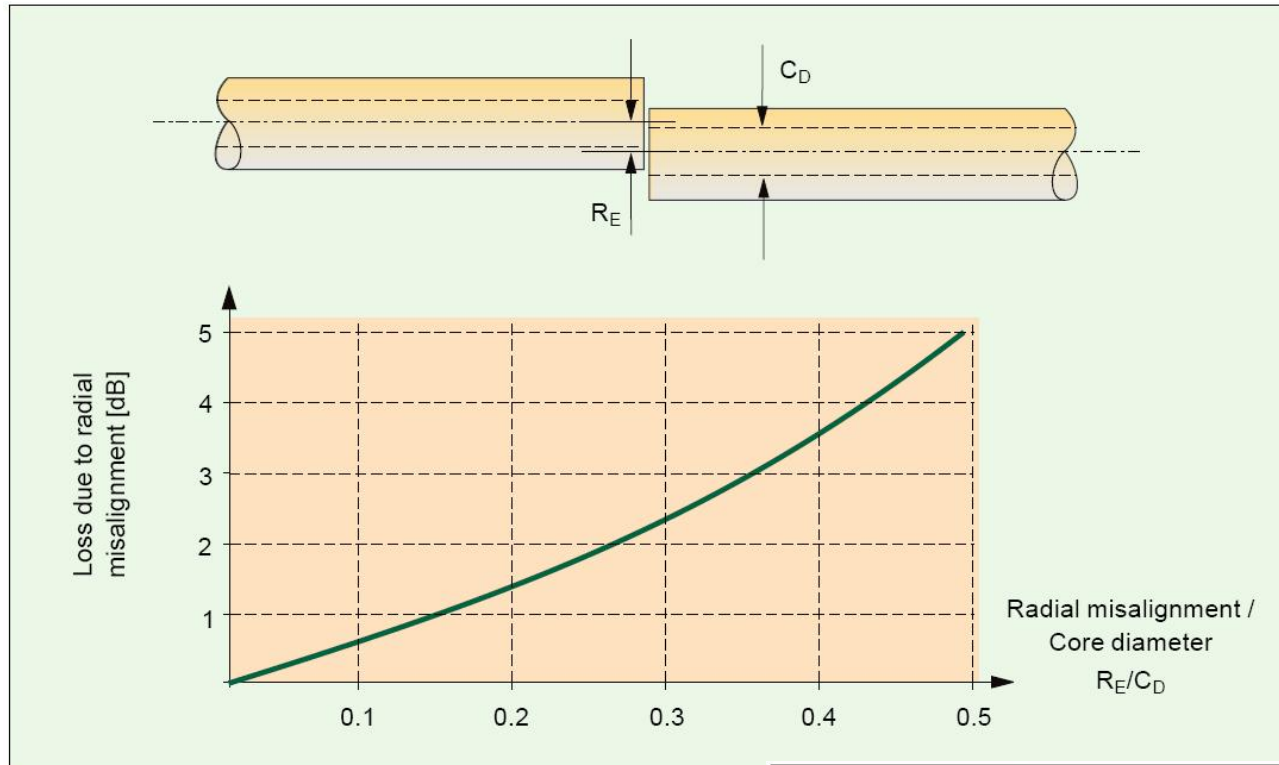

Pierderi – unghi

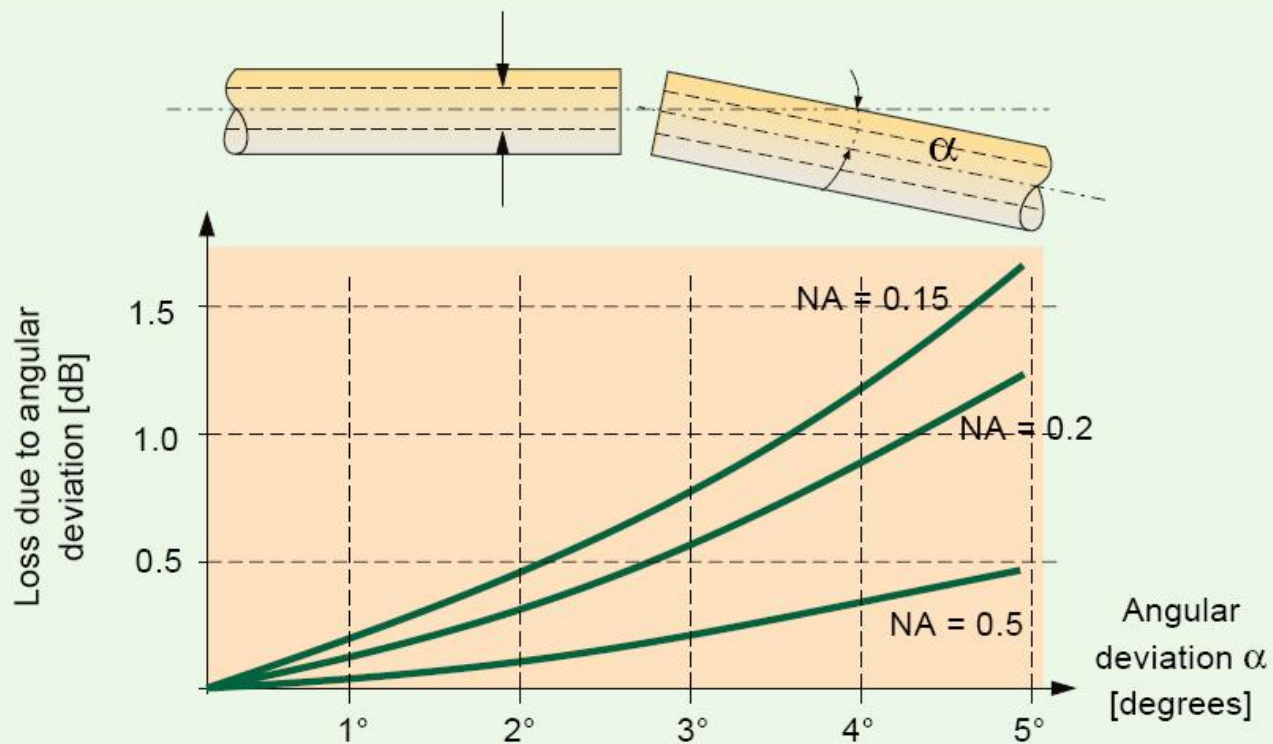

Pierderi – distanta

- ▶ Se foloseste un gel cu indice de refractie egal cu al fibrelor
- ▶ Se aduna pierderile generate de reflexie pe o lamela (pana la 16%)

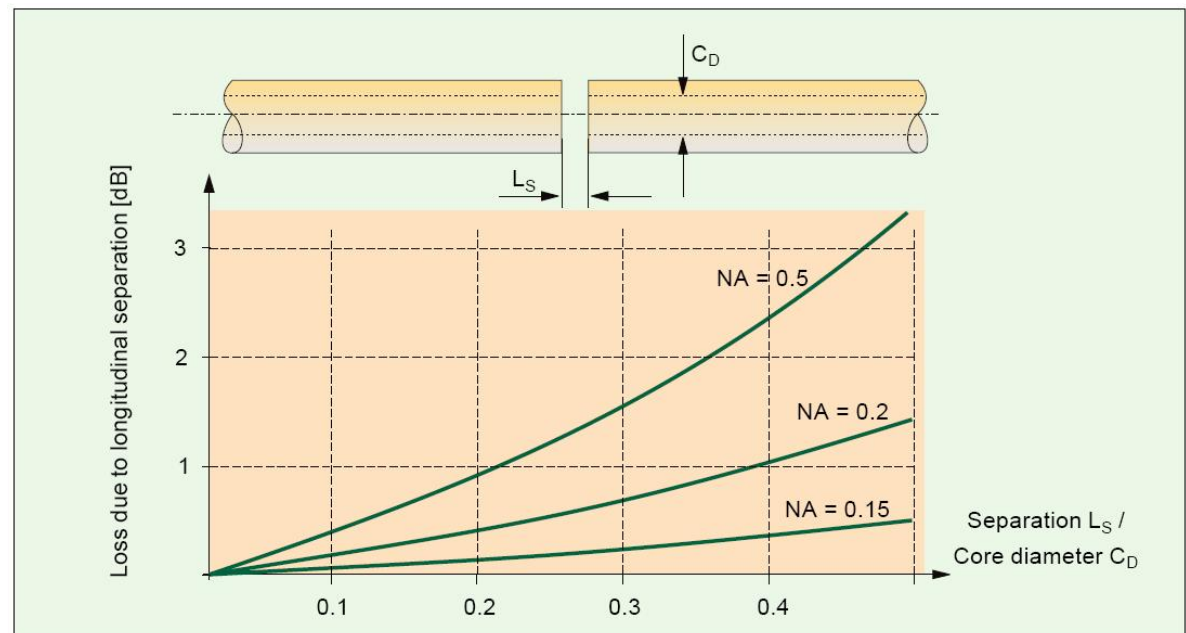

Exemplu

- ▶ Trebuie să realizați o legătură pe fibră optică pe o distanță de 50 km la o viteză de 1Gb/s.

Emitători: = 1.5mW ($\Delta\lambda=2\text{nm}$, diverse λ)	NA = 0.17	$\Phi = 13\mu\text{m}$
Pierderi splice (tehnologie)	0.15 dB/splice	
Pierderi conector	0.5 dB/conector	
Cablu conexiune: L = 20m	NA = 0.12	fibră: 11/125 μm
Cablu conexiune: L = 20m	NA = 0.15	fibră: 11/125 μm
Fibra 1	8 X 5km	
Fibra 2	4 X 10km	
Fibra 3	8 X 5km	
Fibra 4	4 X 10km	
Receptor: Sensitivitate = 1 μW	NA = 0.25	$\Phi = 30\mu\text{m}$

Catalog

Fibra nr. 3

Optical Specifications

Fiber Attenuation

Maximum Attenuation	
Wavelength (nm)	Maximum Value* (dB/km)
1310	0.33 - 0.35
1383**	0.31 - 0.35
1490	0.21 - 0.24
1550	0.19 - 0.20
1625	0.20 - 0.23

*Maximum specified attenuation value available within the stated ranges.
 **Attenuation values at this wavelength represent post-hydrogen aging performance.
 Alternate attenuation offerings available upon request.

Attenuation vs. Wavelength		
Range (nm)	Ref. λ (nm)	Max. α Difference (dB/km)
1285 - 1330	1310	0.03
1525 - 1575	1550	0.02

The attenuation in a given wavelength range does not exceed the attenuation of the reference wavelength (λ_r) by more than the value α .

Macro-bend Loss				
Mandrel Diameter (mm)	Number of Turns	Wavelength (nm)	Induced Attenuation* (dB)	
32	1	1550	≤ 0.03	
50	100	1310	≤ 0.03	
50	100	1550	≤ 0.03	
60	100	1625	≤ 0.03	

*The induced attenuation due to fiber wrapped around a mandrel of a specified diameter.

Point Discontinuity		
Wavelength (nm)	Point Discontinuity (dB)	
1310	≤ 0.05	
1550	≤ 0.05	

Dimensional Specifications

Glass Geometry

Fiber Curl	≥ 4.0 m radius of curvature
Cladding Diameter	125.0 ± 0.7 μ m
Core-Clad Concentricity	≤ 0.5 μ m
Cladding Non-Circularity	$\leq 0.7\%$

Environmental Specifications

Environmental Test	Test Condition	Induced Attenuation	
		1310 nm, 1550 nm & 1625 nm	(dB/km)
Temperature Dependence	-60°C to +85°C*	≤ 0.05	
Temperature Humidity Cycling	-10°C to +85°C* up to 98% RH	≤ 0.05	
Water Immersion	23 \pm 2°C*	≤ 0.05	
Heat Aging	85 \pm 2°C*	≤ 0.05	

*Reference temperature = +23°C

Operating Temperature Range: -60°C to +85°C

Cable Cutoff Wavelength (λ_{ccf})

$\lambda_{ccf} \leq 1260$ nm

Mode-Field Diameter

Wavelength (nm)	MFD (μ m)
1310	9.4 \pm 0.4
1550	10.6 \pm 0.5

Dispersion

Wavelength (nm)	Dispersion Value [ps/(nm \cdot km)]
1550	≤ 18
1625	≤ 23

Zero Dispersion Wavelength (λ_0): 1310 nm $\leq \lambda_0 \leq 1324$ nm
 Zero Dispersion Slope (S_0): ≤ 0.092 ps/(nm \cdot km)

Polarization Mode Dispersion (PMD)

PMD Link Design Value	Value (ps \sqrt km)
Maximum Individual Fiber	≤ 0.2

*Complies with IEC 60794-3: 2001, Section 5.5, Method 1, September 2001.

The PMD link design value is a term used to describe the PMD of concatenated lengths of fiber (also known as PMD $_0$). This value represents a statistical upper limit for total link PMD. Individual PMD values may change when cabled. Corning's fiber specification supports network design requirements for a 0.5 ps \sqrt km maximum PMD.

Coating Geometry

Coating Diameter	245 \pm 5 μ m
Coating-Cladding Concentricity	< 12 μ m

Mechanical Specifications

Proof Test

The entire fiber length is subjected to a tensile stress ≥ 100 kpsi (0.7 GPa)*.
 *Higher proof test levels available.

Length

Fiber lengths available up to 50.4* km/spool.
 *Longer spliced lengths available.

Performance Characterizations

Characterized parameters are typical values.

Core Diameter	8.2 μ m
Numerical Aperture	0.14 NA is measured at the one percent power level of a one-dimensional far-field scan at 1310 nm.
Zero Dispersion Wavelength (λ_0)	1317 nm
Zero Dispersion Slope (S_0)	0.088 ps/(nm \cdot km)
Effective Group Index of Refraction (N_{eff})	1310 nm: 1.4670 1550 nm: 1.4677
Fatigue Resistance Parameter (N_f)	20
Coating Strip Force	Dry: 0.6 lbs. (3N) Wet, 14-day room temperature: 0.6 lbs. (3N)
Rayleigh Backscatter Coefficient (for 1 μ s Pulse Width)	1310 nm: -77 dB 1550 nm: -82 dB
Stimulated Brillouin Scattering Threshold	20 dBm †
Notes:	
(1) When characterized with a transmitter specifying 17 dBm SBS threshold over standard single-mode fiber. While absolute SBS threshold is a function of distance and signal format, NexCor fiber offers a 3 dB improvement over standard single-mode fiber independent of these variables.	

Formulas

Dispersion

$$Dispersion = D(\lambda) = -\frac{S_0}{\lambda} \left[\lambda - \frac{\lambda_0}{\lambda} \right] \text{ ps/(nm}\cdot\text{km)}$$

for 1200 nm $\leq \lambda \leq 1625$ nm

λ = Operating Wavelengths

Cladding Non-Circularity

$$\text{Cladding Non-Circularity} = \left[\frac{\text{Min. Cladding Diameter}}{\text{Max. Cladding Diameter}} \right] \times 100$$

How to Order

Contact your sales representative, or call the Optical Fiber Customer Service Department:
 Ph: 607-248-2000 (U.S. and Canada)
 +44-1244-287-4317 (Europe)
 Email: opticalfibres@corning.com
 Please specify the fiber type, attenuation and quantity when ordering.

Corning Incorporated

www.corning.com/opticalfiber
 One Riverfront Plaza
 Corning, NY 14831
 U.S.A.

Ph: 800-525-2324 (U.S. and Canada)
 607-786-8125 (International)
 Fx 800-539-3632 (U.S. and Canada)
 607-786-8344 (International)

Email: cofc@corning.com

Europe

Ph: 00 800 6620 6621 (U.K., Ireland, Italy, France, Germany, The Netherlands, Spain and Sweden)
 +1 607 786 8125 (All Other Countries)
 Fx: +1 607 786 8344

Asia Pacific

Australia
 Ph: 1-800-148-690
 Fx: 1-800-148-568

Indonesia
 Ph: 001-800-015-721-1261
 Fx: 001-800-015-721-1262

Malaysia
 Ph: 1-800-80-3156
 Fx: 1-800-80-3155

Philippines
 Ph: 1-800-1-116-0338
 Fx: 1-800-1-116-0339

Singapore
 Ph: 800-1300-955
 Fx: 800-1300-956

Thailand
 Ph: 001-800-1-1-721-1261
 Fx: 001-800-1-1-721-1264

Latin America

Brazil
 Ph: 00817-762-4732
 Fx: 00817-762-4996

Mexico
 Ph: 001-800-235-1719
 Fx: 001-800-339-1472

Venezuela
 Ph: 800-1-4418
 Fx: 800-1-4419

Greater China

Email: CCcofc@corning.com
 Beijing
 Ph: (86) 10-6505-5066
 Fx: (86) 10-6505-5077

Hong Kong
 Ph: (852) 2807-2723
 Fx: (852) 2807-2152

Shanghai
 Ph: (86) 21-3222-4668
 Fx: (86) 21-6288-1575

Taiwan
 Ph: (886) 2-2716-0338
 Fx: (886) 2-2716-0339

NexCor is a trademark, and Corning and SM-216 are registered trademarks, of Corning Incorporated, Corning, N.Y.

Any warranty or any claims relating to any Corning optical fiber is only contained in the written agreement between Corning Incorporated and the direct purchaser of such fiber.

©2003 Corning Incorporated

Intrebari

- ▶ (1 p) Ce lungime de undă veți alege pentru emițător? Justificați.
- ▶ (2p) Alegeți fibrele pe care le veți utiliza. Justificați. Realizați schița legăturii
- ▶ (1 p) Puteți realiza o legătură funcțională? Justificați.

<i>Zero Dispersion Wavelength (λ_0)</i>	1317 nm
<i>Zero Dispersion Slope (S_0)</i>	0.088 ps/(nm ² •km)

Legatura

► Bilantul puterilor

$$A_{tot}[\text{dB}] = \sum_i A_i[\text{dB}]$$

$$P_e[\text{dBm}] \pm A_{tot}[\text{dB}] \geq S_r[\text{dBm}] + M[\text{dB}]$$

Maximum Attenuation

Wavelength (nm)	Maximum Value* (dB/km)
1310	0.33 – 0.35
1383**	0.31 – 0.35
1490	0.21 – 0.24
1550	0.19 – 0.20
1625	0.20 – 0.23

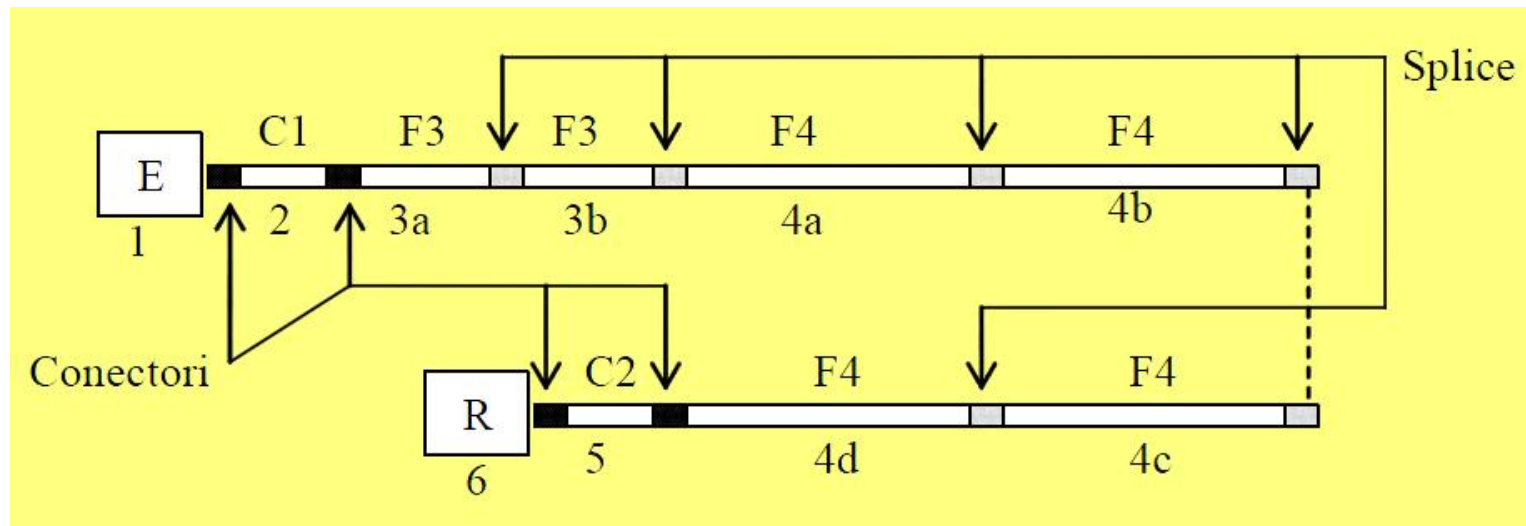

Sistem

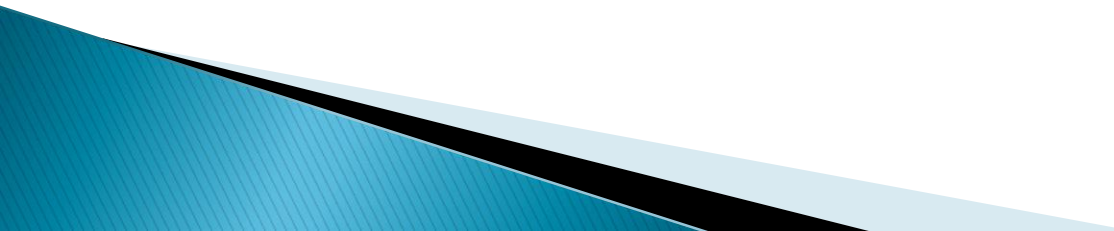
- ▶ 1. Emitator
 - ▶ 2. Cablu 1 de conexiune
 - ▶ 3. Fibra 3 (2 cabluri a 5 km fiecare: 3a,3b)
 - ▶ 4. Fibra 4 (4 cabluri a 10 km fiecare: 4a,4b,4c,4d)
 - ▶ 5. Cablu 2 de conexiune
 - ▶ 6. Receptor
- 

Pierderi

- ▶ Atenuare datorata conectorilor
- ▶ Atenuare datorata splice-urilor
- ▶ Atenuare in fibra
- ▶ Atenuare datorata diferentelor de apertura numerica
 - apare **numai** la trecerea de la un dispozitiv cu NA mai mare la un dispozitiv cu NA mai mic
- ▶ Atenuare datorata diferentelor de diametru
 - apare **numai** la trecerea de la un dispozitiv cu diametru mai mare la un dispozitiv cu diametru mai mic

Dispersie

$$\Delta\tau_{\text{mod}} \cong \frac{L \cdot n_1 \cdot \Delta}{2\sqrt{3} \cdot c} \approx \frac{L \cdot NA^2}{4\sqrt{3} \cdot c \cdot n_1}$$

$$\Delta\tau_{\text{mod}} \cong \frac{L \cdot n_1 \cdot \Delta^2}{4\sqrt{3} \cdot c}$$

$$\Delta\tau_{\text{cr}} = D(\lambda) \cdot \Delta\lambda \cdot L$$

$$D(\lambda) = \frac{S_0}{4} \cdot \left(\lambda - \frac{\lambda_0^4}{\lambda^3} \right)$$

$$\Delta\tau_{\text{tip}} = \sum_i \Delta\tau_i$$

$$\Delta\tau_{\text{tot}} = \sqrt{\Delta\tau_{\text{cr}}^2 + \Delta\tau_{\text{mod}}^2} \quad B_{\text{opt}} = \frac{0.44}{\Delta\tau_{\text{tot}} [\text{ns}]} \quad [\text{GHz}] \quad B_{\text{opt}} = \sqrt{2} B_{\text{el}}$$

$$V [\text{Gb/s}] \cong 2 \cdot B_{\text{el}}$$



$$B_{\text{3dB,electric}} (\text{GHz}) = \frac{0.35}{T(\text{ns})}$$

$$\text{NRZ}_{\text{viteza date}} (\text{Gbit/s}) = \frac{1}{T_{\text{impuls}} (\text{ns})} \leq \frac{0.67}{T(\text{ns})}$$

Lungime maxima

▶ limitata de atenuare

$$\text{Atenuare}[\text{dB/km}] = \frac{\text{Pierderi}[\text{dB}]}{\text{lungime}[\text{km}]}$$

$$L_{\max} = \frac{\Delta P_{\min} [\text{dB}]}{A_{\max} [\text{dB/km}]} = \frac{P_{e\min} [\text{dBm}] - S_{r\max} [\text{dBm}]}{A_{\max} [\text{dB/km}]}$$

▶ limitata de viteza

$$B_{el\min} \cong \frac{V_{\min} [\text{Gb/s}]}{2}$$

$$B_{opt\min} = \frac{1}{\sqrt{2}} B_{el\min}$$

$$\Delta\tau_{tot\max} [\text{ns}] = \frac{0.44}{B_{opt\min} [\text{GHz}]}$$

$$L_{\max} = \frac{\Delta\tau_{\max}}{D(\lambda) \cdot \Delta\lambda}$$

Contact

- ▶ Laboratorul de microunde si optoelectronica
- ▶ <http://rf-opto.etti.tuiasi.ro>
- ▶ rdamian@etti.tuiasi.ro