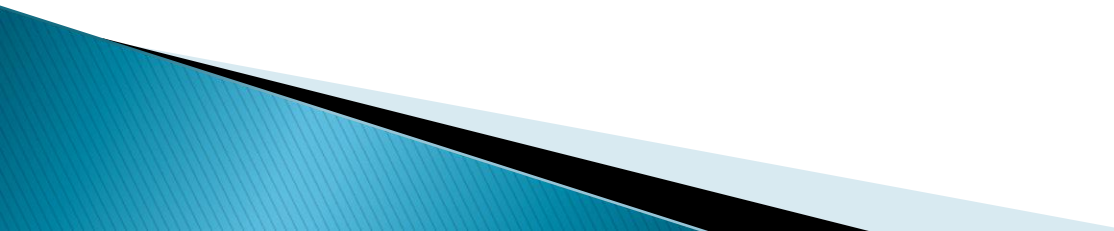

Optoelectronică, structuri și tehnologii

Curs 6
2013/2014

Capitolul 11

- ▶ **Behzad Razavi**
Design of Integrated Circuits for Optical Communications
 - ▶ carte1.pdf (2,3)
 - ▶ 29 pg.
- 

Lista subiecte

- ▶ Amplificatoare transimpedanță
 - 4.1
 - 4.1.1
 - 4.2
 - 4.2.1
 - 4.3
 - 4.3.1
- ▶ Circuite pentru controlul emițătoarelor optice
 - 10.3
 - 10.3.1
 - 10.4
 - 10.4.1

Problema simpla?

- ▶ Sursa luminoasa: 7.7 dBm
- ▶ Atenuarea fibrei: 1.16 dB/km
- ▶ Puterea la iesire: 105 μ W

- ▶ Lungimea fibrei: ?

Problema simpla?

- ▶ Logaritmic
- ▶ $P_{\text{out}} = 10 \cdot \log (105 \mu\text{W} / 1 \text{ mW}) = -9.8 \text{ dBm} !$
- ▶ Atenuarea : $A_f = P_{\text{in}}[\text{dBm}] - P_{\text{out}}[\text{dBm}] = 17.5\text{dB} !$
- ▶ $L = A_f / A_{\text{dB/km}} = 17.5\text{dB} / 1.16\text{dB/km} = 15.08 \text{ km}$

LED

Dioda electroluminescenta

Capitolul 8

Caracteristici LED

▶ Dezavantaje

- Putere redusa (cuplata in fibra) $\sim 100\mu\text{W}$
- Banda (viteza) reduse $\sim 150\text{MHz}$ (300Mb/s)
- Spectru larg $\sim 0.05 \lambda$
- Lumina necoerenta si nedirectiva

▶ Avantaje

- Structura interna mult mai simpla (fara suprafete reflective, straturi planare)
- Cost (dispozitiv si circuit de comanda)
- Durata de viata
- Insensibilitate la temperatura
- Liniaritate (modulatie analogica)

LED – Principiul de operare

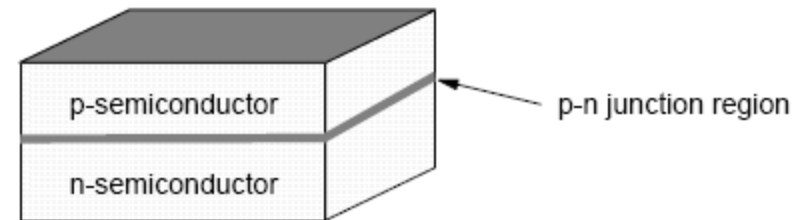
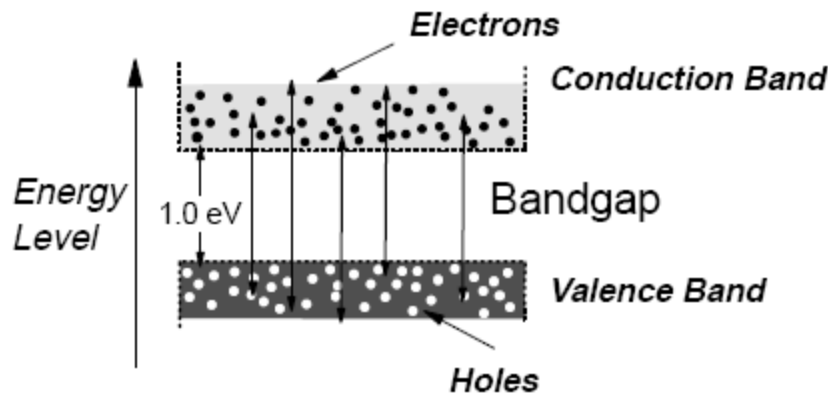
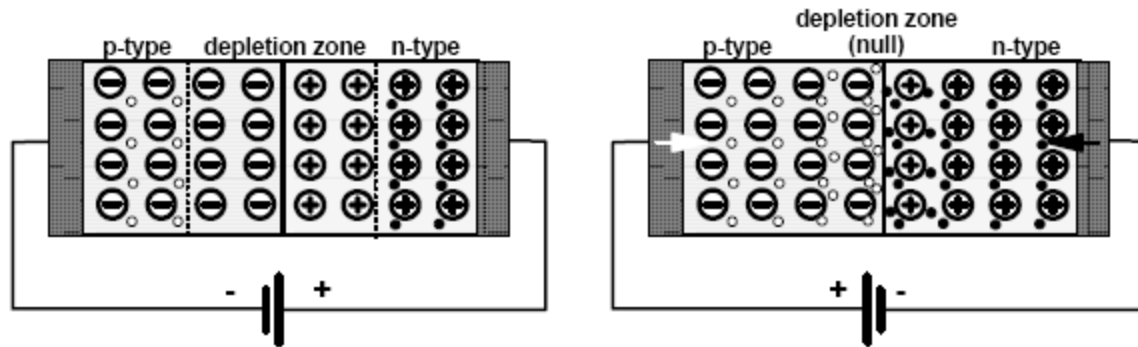

LED – Principiul de operare

- ▶ Lumina este generata de o recombinare radiativa dintre un electron si un gol
- ▶ Recombinarea neradiativa transforma energia in caldura
- ▶ Eficienta cuantica $\eta = \frac{R_r}{R_r + R_{nr}}$
- ▶ La recombinarea radiativa $E_g = h\nu; \lambda = \frac{hc}{E_g}$
- ▶ Recombinare eficienta:
 - alegerea judicioasa a materialului
 - concentrarea purtatorilor in zona jonctiunii
- ▶ Lungimea de unda depinde de temperatura de functionare a dispozitivului: $0.6\text{nm}/^\circ\text{C}$

Aplicatii majore LED

▶ Comunicatii

- Infrarosu (InGaAsP)

▶ Vizibil

- Spectru vizibil (GaAlAs)

▶ Iluminare

- Putere ridicata, lumina alba (GaInN)

Lățimea benzii interzise/lungime de undă pentru materialele uzuale

Material	Formula	Wavelength Range λ (μm)	Bandgap Energy W_g (eV)
Indium Phosphide	InP	0.92	1.35
Indium Arsenide	InAs	3.6	0.34
Gallium Phosphide	GaP	0.55	2.24
Gallium Arsenide	GaAs	0.87	1.42
Aluminium Arsenide	AlAs	0.59	2.09
Gallium Indium Phosphide	GaInP	0.64-0.68	1.82-1.94
Aluminium Gallium Arsenide	AlGaAs	0.8-0.9	1.4-1.55
Indium Gallium Arsenide	InGaAs	1.0-1.3	0.95-1.24
Indium Gallium Arsenide Phosphide	InGaAsP	0.9-1.7	0.73-1.35

$$E_g = h\nu; \quad \lambda = \frac{hc}{E_g}; \quad \lambda[\mu\text{m}] = \frac{1.240}{E_g[\text{eV}]}$$

- ▶ h constanta lui Plank
 $6.62 \cdot 10^{-32} \text{ W s}^2$
- ▶ c viteza luminii **in vid**
 $2.998 \cdot 10^8 \text{ m/s}$
- ▶ benzi energetice: λ_0 , $\Delta\lambda$

Detalii constructive – 1

- ▶ Recombinarea unei perechi electron–gol necesita conservarea "impulsului rețelei" (cvasiimpuls)
 - ▶ In Si si Ge aceasta conditie presupune aparitia unui fonon intermediar (tranzitie indirecta) a carui energie se transforma in caldura
 - ▶ Majoritatea aliajelor de aluminiu Al de asemenea au tranzitie indirecta
- ▶ Se utilizeaza aliaje de Ga Al As sau In Ga As P
- ▶ Materialele utilizate trebuie sa fie "transparente" la lungimile de unda emise

LED cu heterojunțiuni – principiu

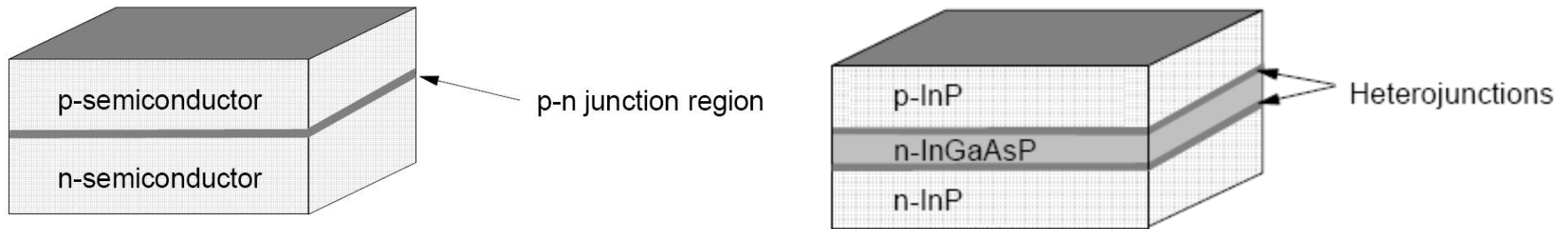

- ▶ **Orice** jonctiune p–n emite lumina
- ▶ O jonctiune p–n obisnuita este foarte subtire
 - volumul in care apar recombinari este foarte mic
 - eficienta luminoasa, redusa
- ▶ lumina este emisa in toate directiile
 - cantitatea de lumina utilizabila (intr–o anumita directie) este redusa

Detalii constructive – 2

- ▶ Spatierea atomilor in diferitele straturi trebuie sa fie egala (toleranta 0.1%) pentru a nu se introduce defecte mecanice la jonctiune
 - limitare a aliajelor utilizabile
 - aparitia defectelor
 - creste ineficienta (recombinari neradiative)
 - scade durata de viata a dispozitivului

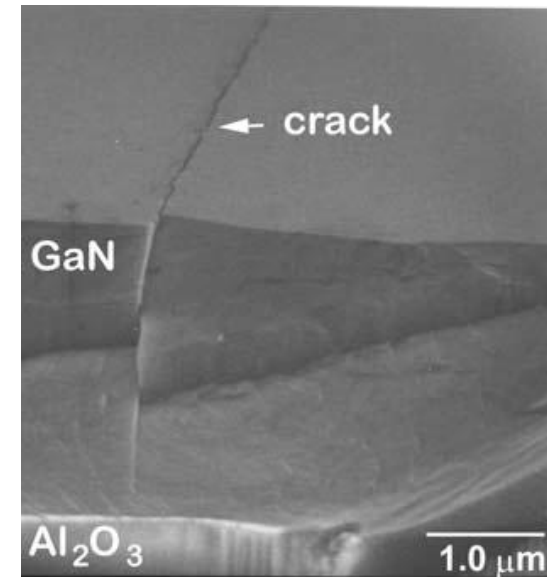

Dependența benzii interzise de constanta rețelei

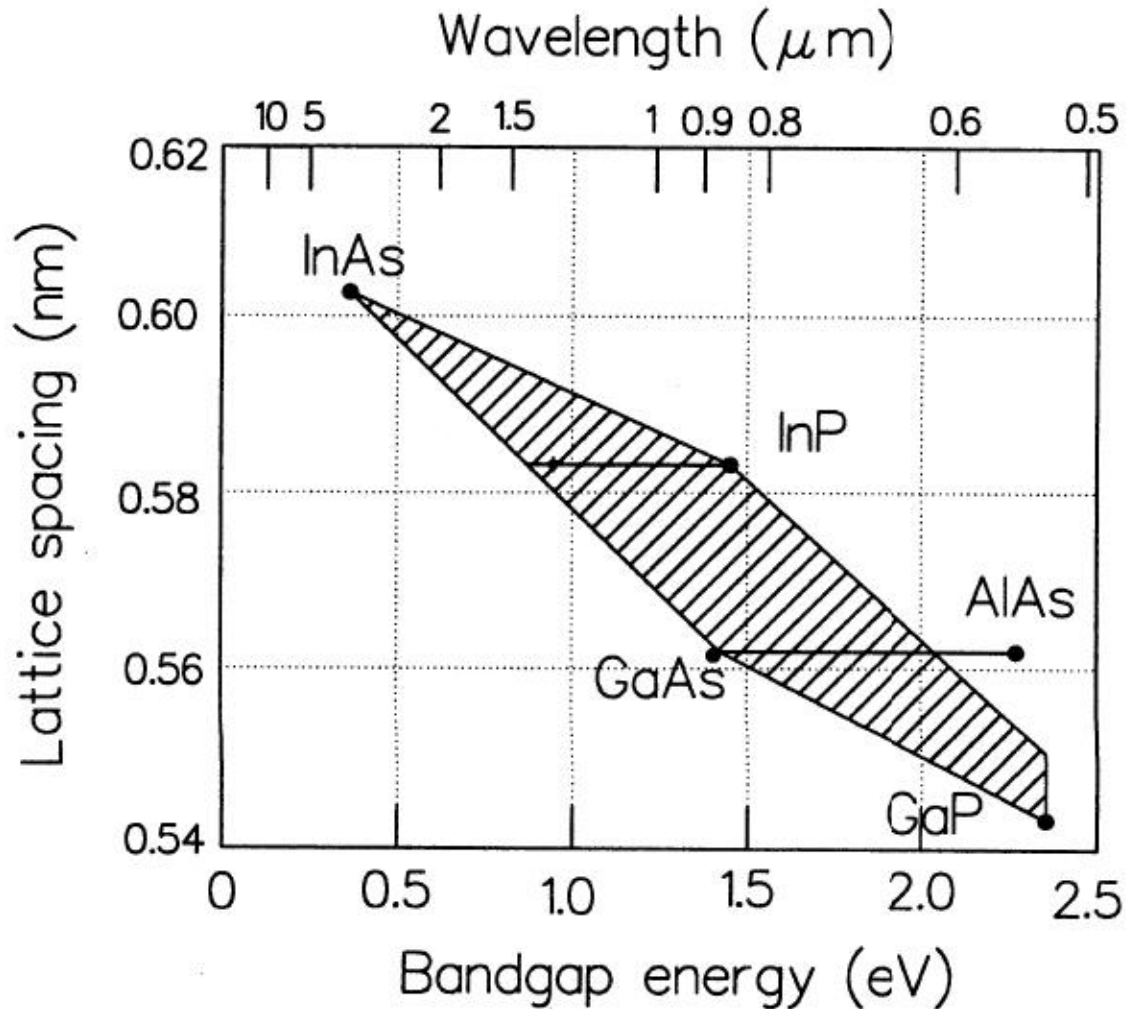
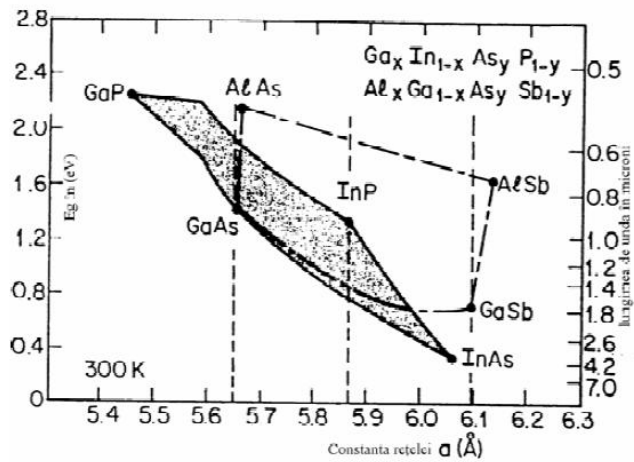

Materiale

- ▶ Lungimi de unda mici (spectru vizibil – 1 000nm)
 - GaP (665nm), $\text{GaAs}_y\text{P}_{1-y}$
 - GaAs (900nm), $\text{Ga}_{1-x}\text{Al}_x\text{As}$ (AlAs – 550nm)
- ▶ Lungimi de unda mari (1 000÷1 700nm)
 - $\text{In}_x\text{Ga}_{1-x}\text{As}_y\text{P}_{1-y}$
 - x,y concentratii relative in aliaj a materialelor corespunzatoare
 - x,y alese din considerente privind
 - lungimea de unda
 - spatierea atomilor
- ▶ Ultraviolet – Albastru: GaInN

Materiale

▶ Lungimi de unda mici

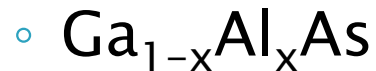

- E_g (in eV) $E_g = 1.424 + 1.266 \cdot x + 0.266 \cdot x^2$

- limitare pentru tranzitie directa $0 < x < 0.37$

▶ Lungimi de unda mari

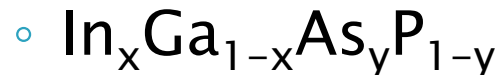

- E_g (in eV) $E_g = 1.35 - 0.72 \cdot y + 0.12 \cdot y^2$

- Tipic substratul este InP

- Spatierea atomilor (lattice spacing) corespunzatoare InP $x = \frac{0.4526}{1 - 0.031 \cdot y}$

- Exemplu: 1300nm se obtine cu $y=0.589$ si $x=0.461$,

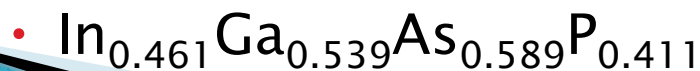

LED cu heterojunțiuni – principiu

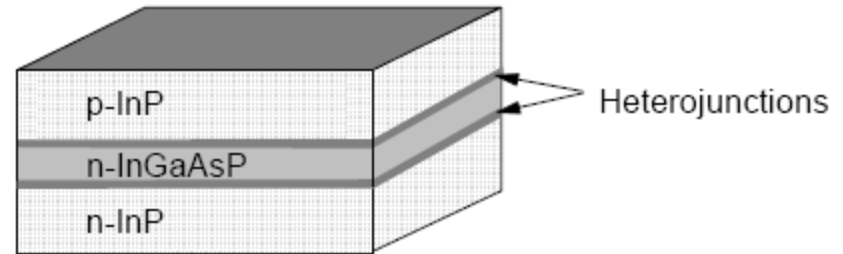
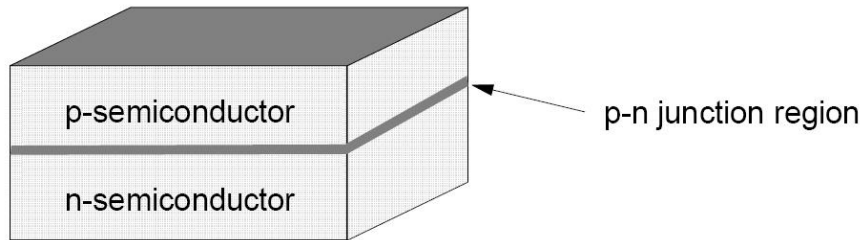

- ▶ Structura de nivele energetice permite capturarea purtătorilor între cele două heterojunțiuni

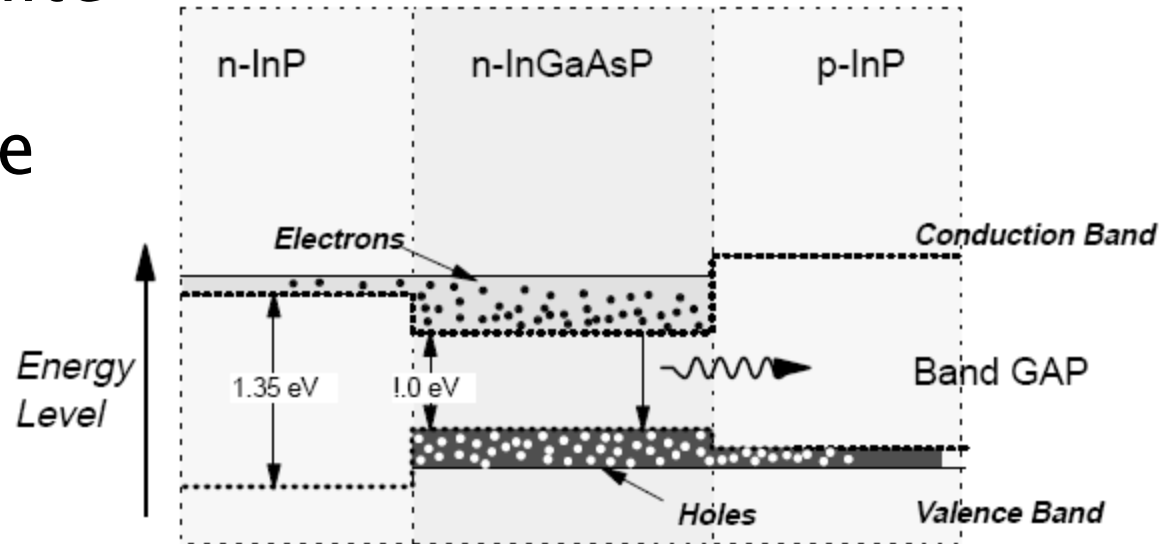

LED cu heterojunțiuni – principiu

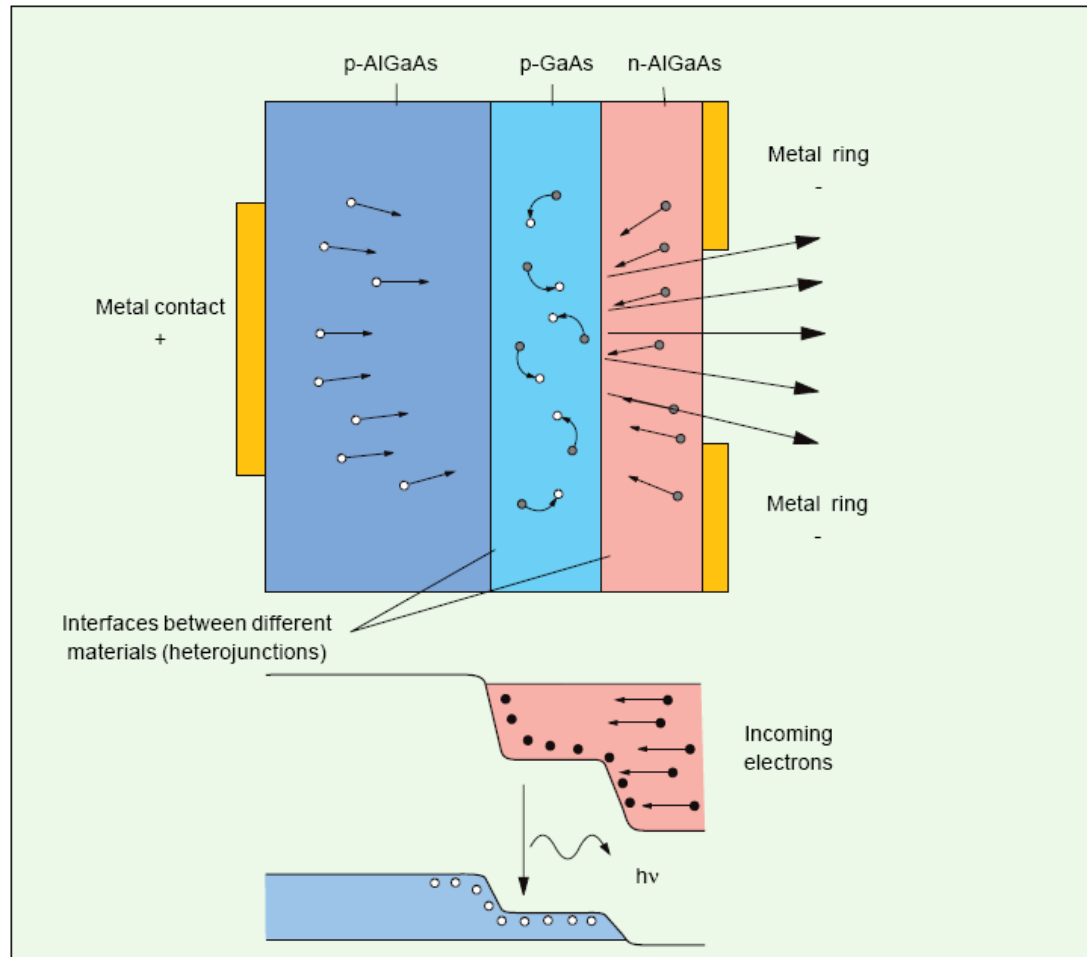

LED cu heterojunțiuni – principiu

▶ Concentrare verticală a purtătorilor

- Electronii sunt atrași din zona n în zona activă
- O barieră energetică existentă între zona activă și zona n concentrează electronii în zona activă
- Situație similară corespunzătoare golurilor
- Purtătorii sunt concentrați în zona activă, crescând eficiența

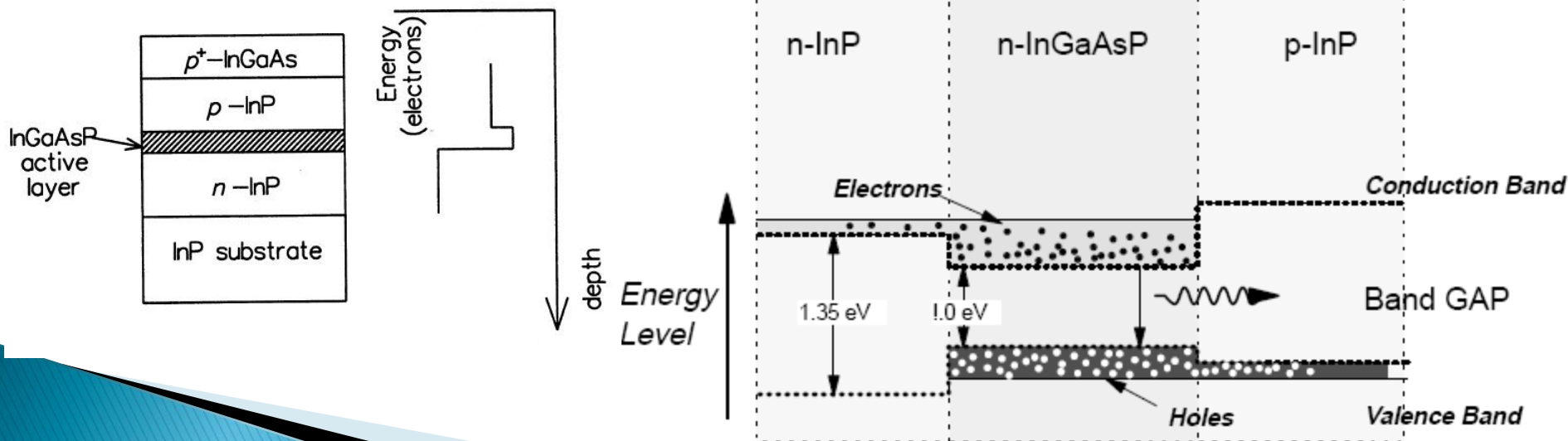

LED cu heterojunțiuni – principiu

- ▶ Concentrare verticală a luminii
 - în general la diode laser (eficiența procesului LASER depinde de intensitatea luminoasă)
 - prezenta și la LED pentru creșterea eficienței luminoase: dirijarea luminii spre exterior și evitarea absorbției interne

- ▶ Straturile din materiale diferite au indici de refracție diferiți formând un ghid dielectric

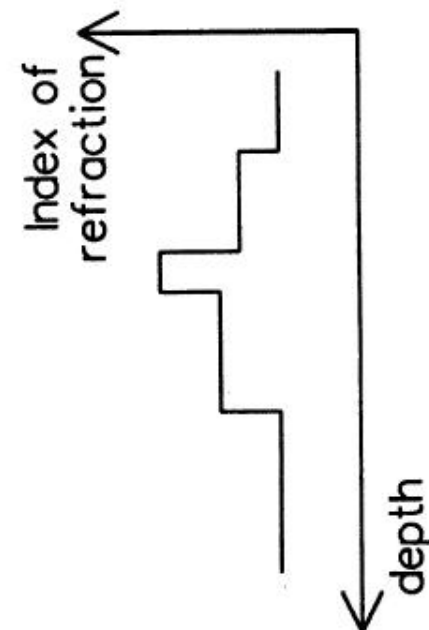
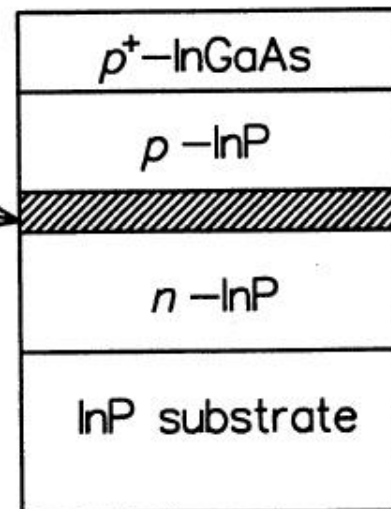

LED cu heterojunțiuni – principiu

► Concentrare orizontală a curentului

- Eficiența conversiei depinde de concentrația de purtători, deci e necesară creșterea densității de curent în zona activă (20–50 μm)
- Se utilizează:
 - strat izolator (tipic SiO_2) cu o deschidere în dreptul zonei active
 - Bombardarea cu protoni a regiunii din jurul zonei active
- Alte metode:
 - eliminarea materialului în jurul zonei active (mesa structure)
 - difuzie de Zn în zona centrală

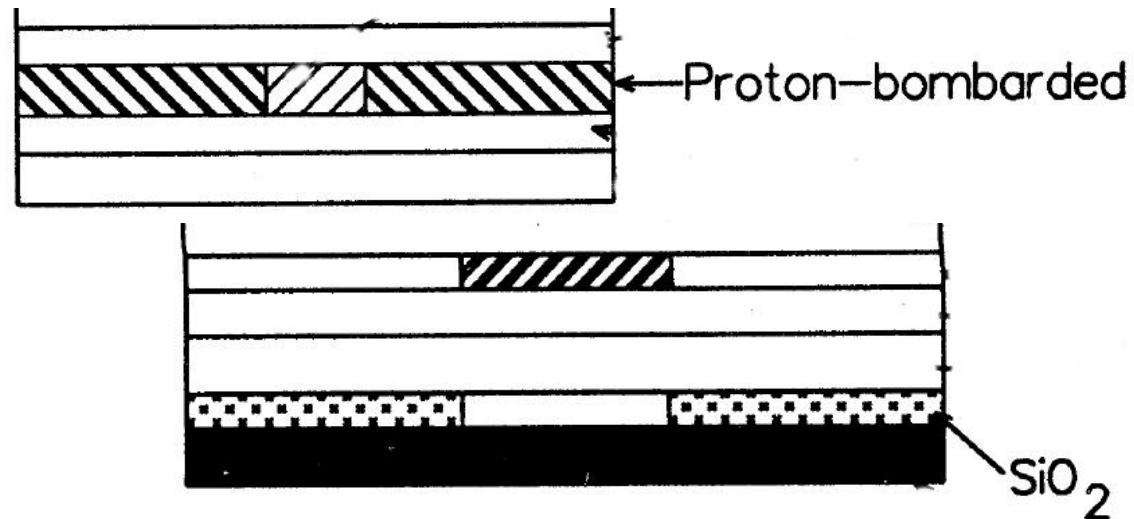

LED cu heterojunțiuni – detalii

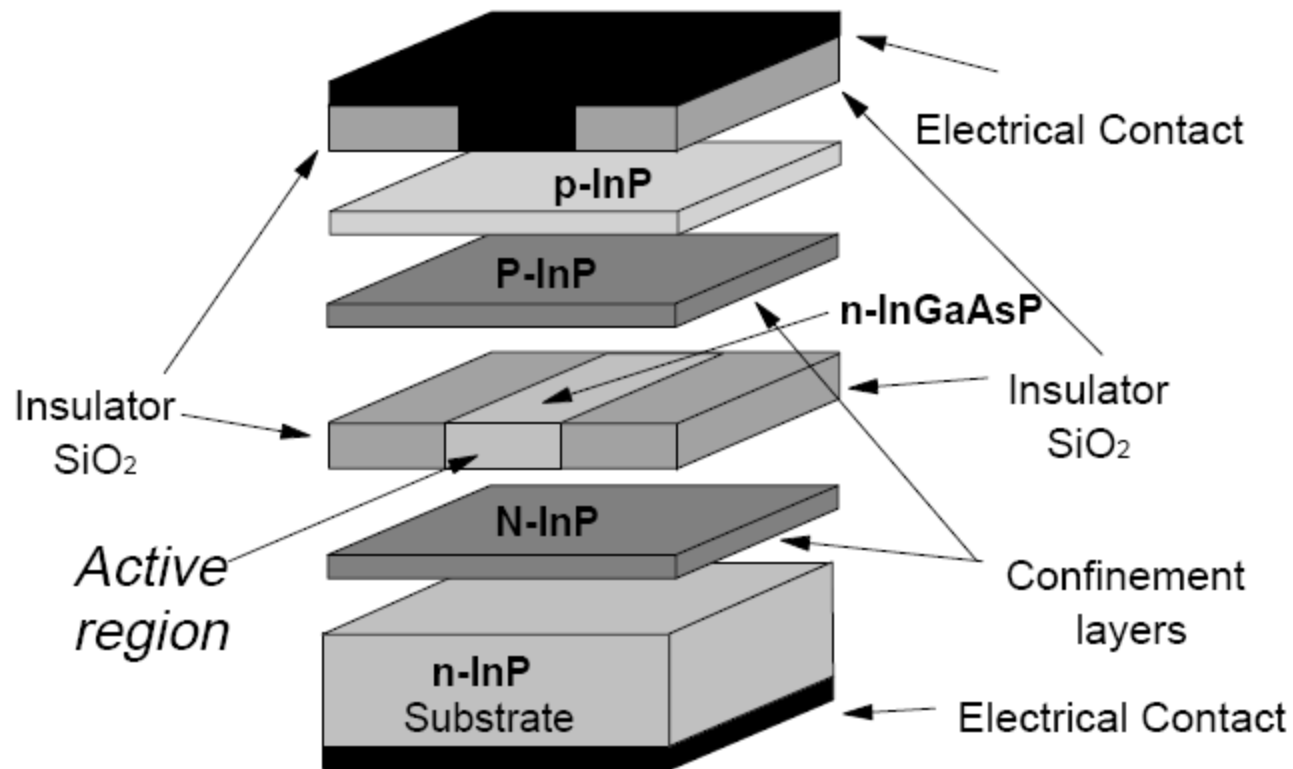

Structuri constructive pentru LED

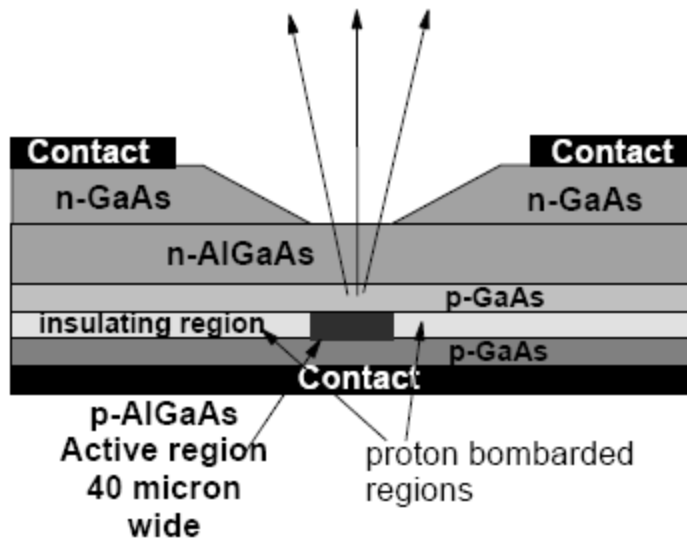

Burrus Surface Emitting LED (SLED)

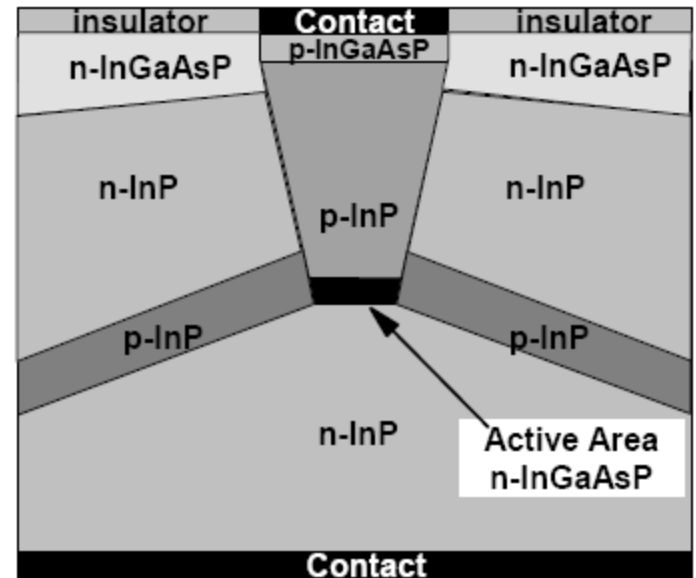

Edge Emitting LED (ELED)

LED cu emisie de suprafață

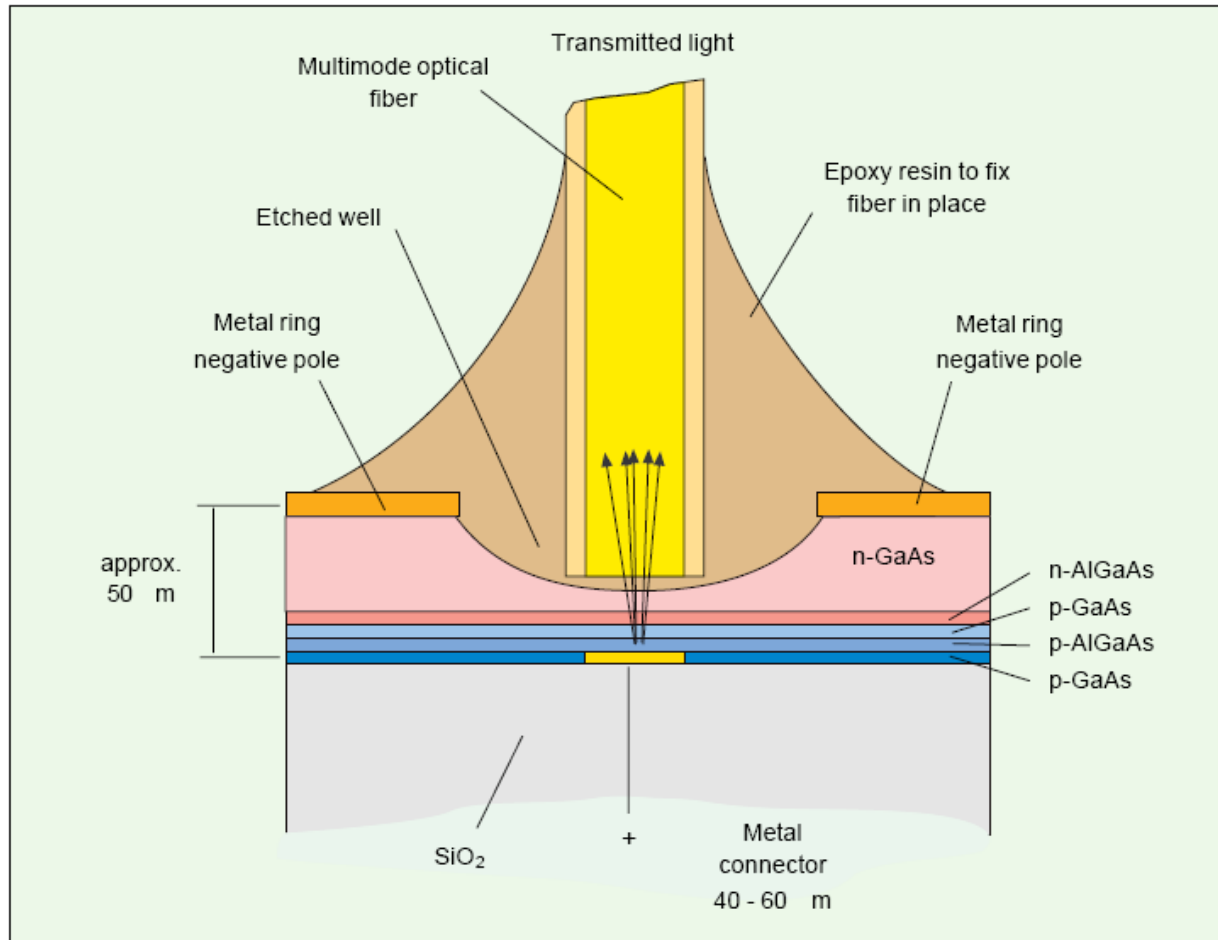

SLED InGaAsP – constructie

- ▶ InGaAsP
- ▶ 4 straturi
 - n InP $\sim 2 \div 5 \mu\text{m}$
 - p InGaAsP $\sim 0.4 \div 1.5 \mu\text{m}$
 - p InP $\sim 1 \div 2 \mu\text{m}$
 - p⁺ InGaAs $\sim 0.2 \mu\text{m}$
- ▶ Latimea zonei active
 - $\sim 20 \div 50 \mu\text{m}$ diametru

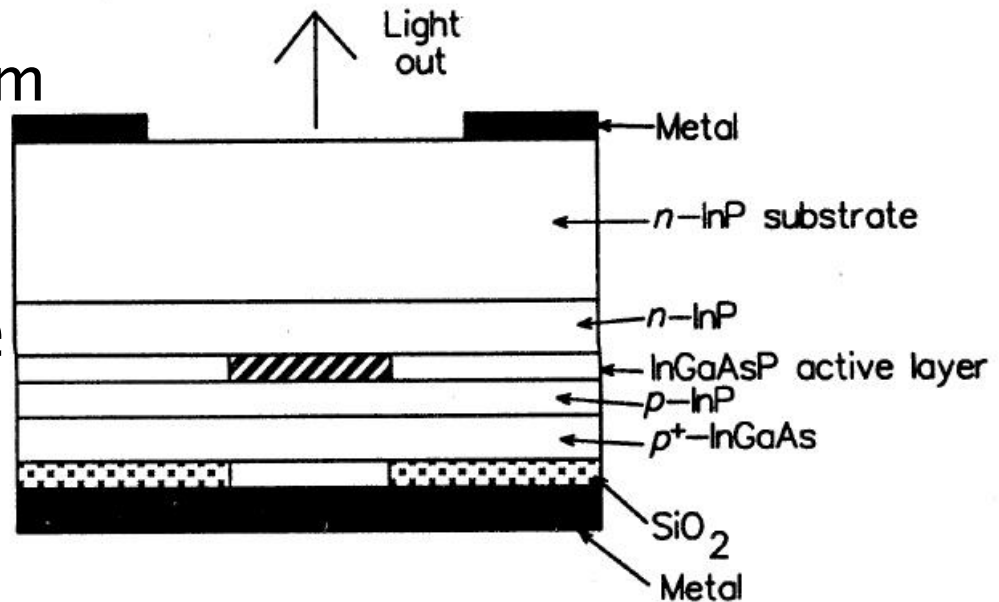

SLED GaAlAs – constructie

- ▶ GaAlAs
- ▶ diferenta principala e data de absorbtia crescuta a substratului GaAs, care este eliminat partial pentru a permite accesul luminii spre exterior

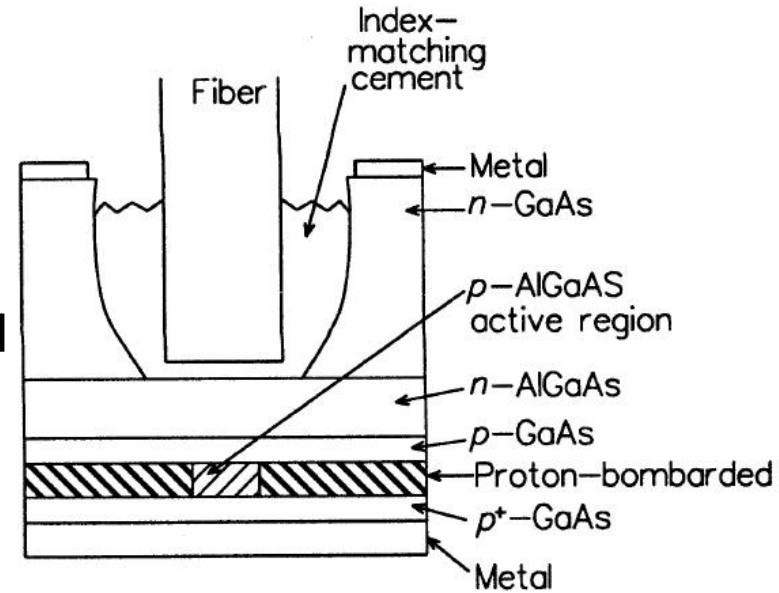

LED cu emisie laterală

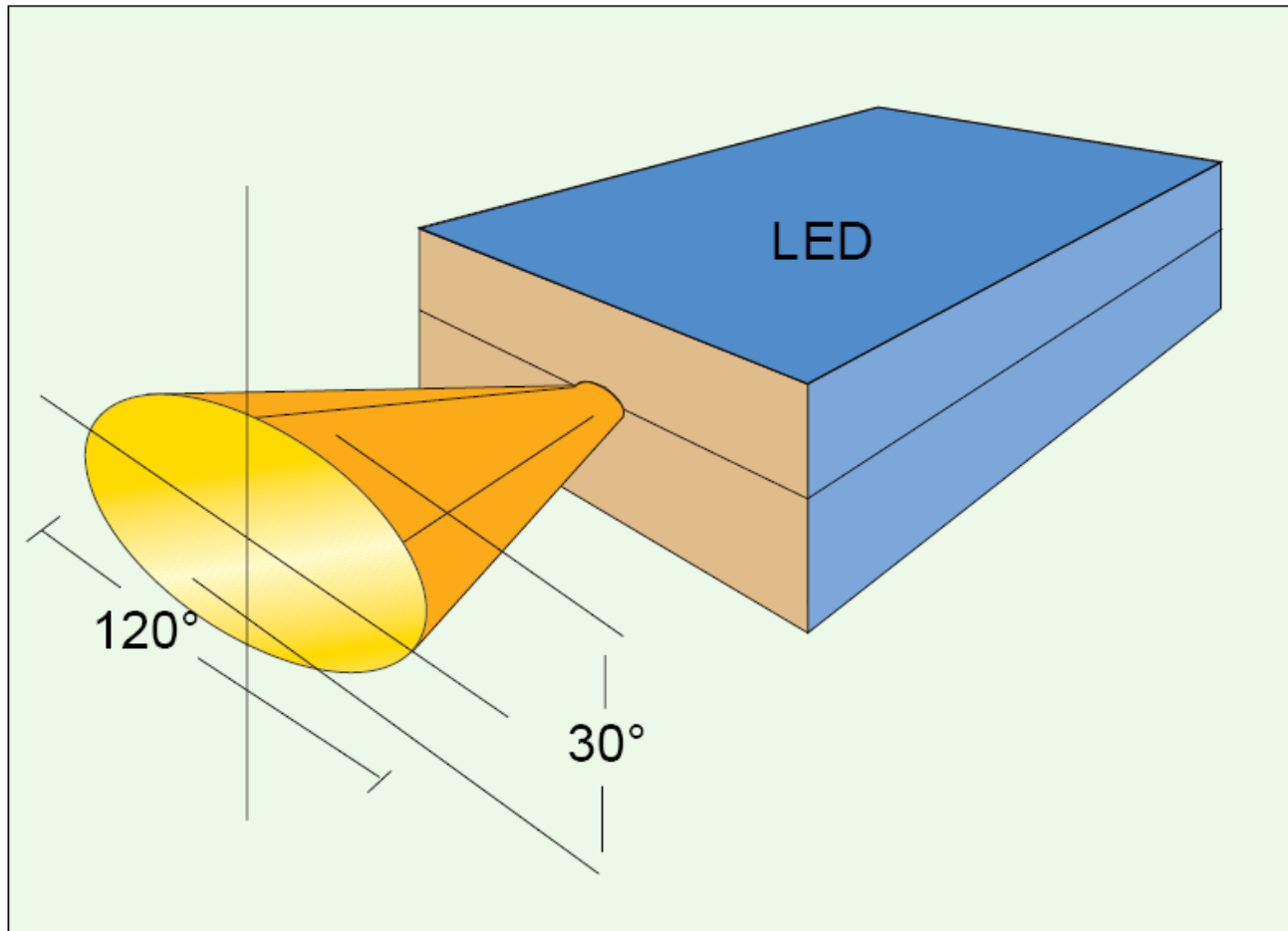

ELED – constructie

- ▶ InGaAsP
- ▶ strict pentru comunicatii
- ▶ Cele patru straturi sunt in general similare
- ▶ Stratul activ este mult mai subtire decat la SLED $\sim 0.05 \div 0.25 \mu\text{m}$
- ▶ Regiunea activa
 - latime $50 \div 70 \mu\text{m}$
 - lungime $100 \div 150 \mu\text{m}$
 - p InP $\sim 1 \div 2 \mu\text{m}$
 - p⁺ InGaAs $\sim 0.2 \mu\text{m}$
- ▶ Apare concentrarea verticala a luminii

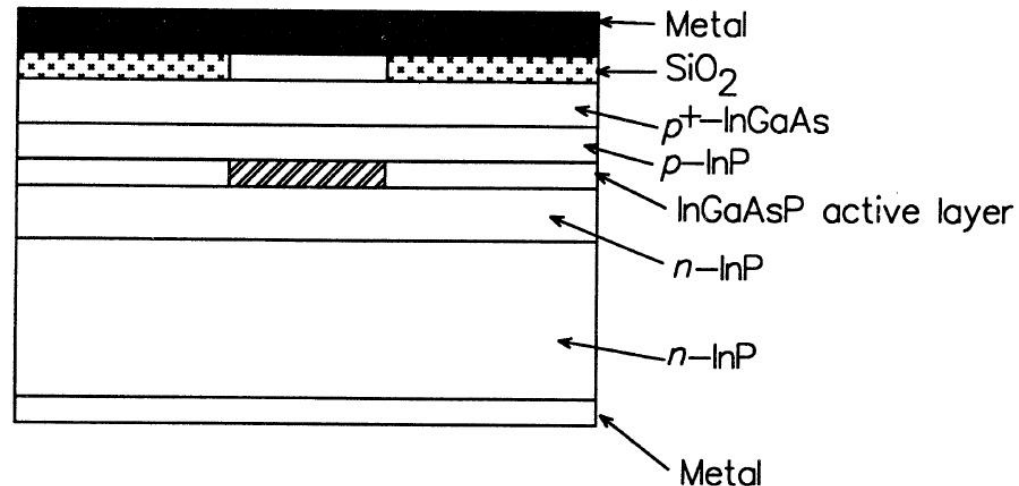

Emisia luminii spre exterior

- ▶ Indici de refractie ridicati
 - InP $n=3.4$
 - GaAs $n=3.6$
- ▶ Doua probleme generate
 - pierderi prin reflexie ridicate
 - unghi critic de numai 15°

Emisia luminii spre exterior

▶ Solutii

- utilizarea unui material intermediar pentru adaptarea indicelui de refractie (rasina epoxidica)
- adaptarea formei de iesire din dispozitiv – forma de dom
 - eficienta de cuplaj

interfata plana
semiconductor
aer

$$\frac{1}{n \cdot (n+1)^2}$$

dom

$$\frac{2n}{(n+1)^2}$$

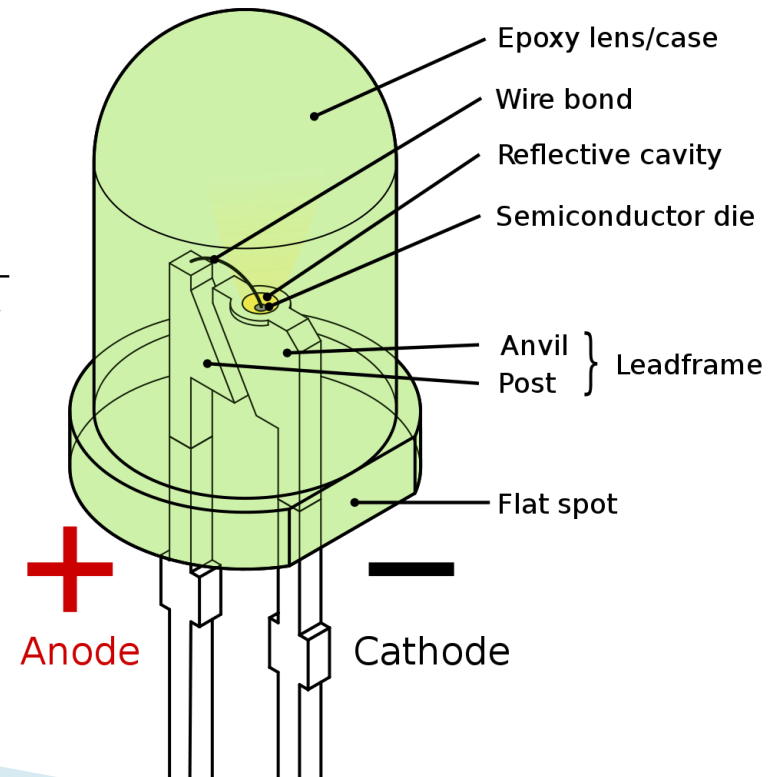

Cuplarea luminii în fibră

(a) Grin Lens

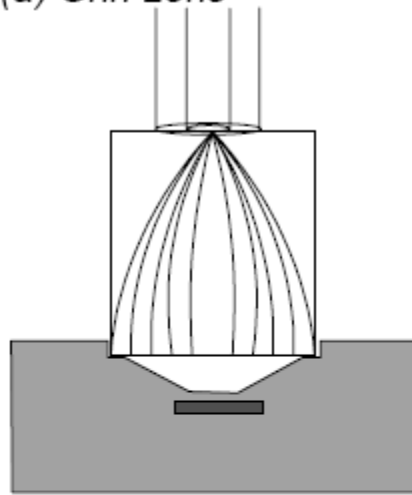

(b) Ball Lens

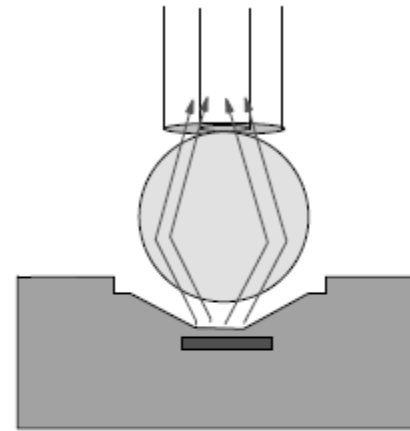

(c) Direct coupling

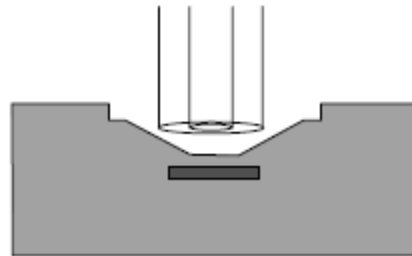

(d) Lensed fibre end

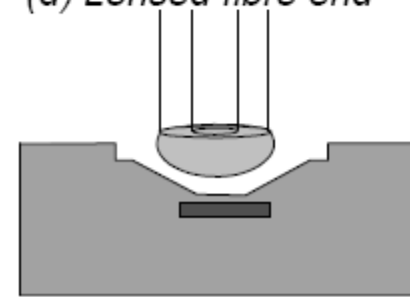

numai pentru fibre multimod cu salt de indice

Directivitatea radiatiei exterioare

▶ SLED

- radiatia este emisa cu simetrie circulara, in interiorul unui con cu unghi la varf tipic de 60°
- Viewing Half Angle $\sim 10 \div 15^\circ$

▶ ELED

- radiatia emisa nesimetric in forma de con eliptic
 - perpendicular pe jonctiune $\sim 60^\circ$
 - paralel cu jonctiunea $\sim 30^\circ$

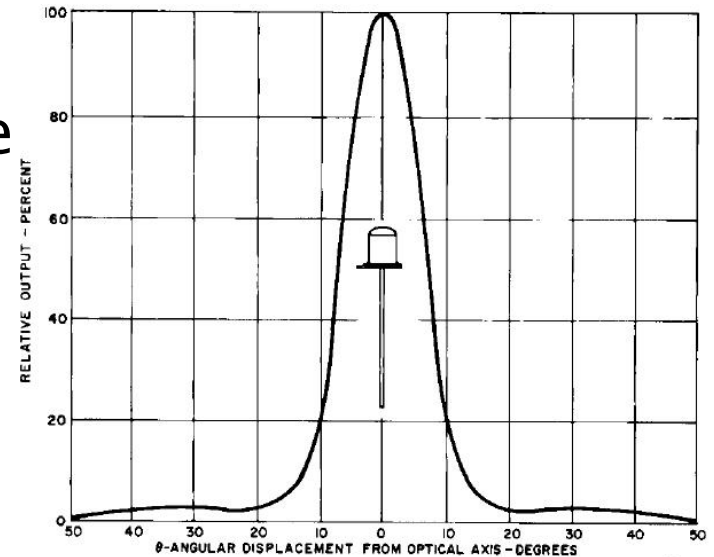
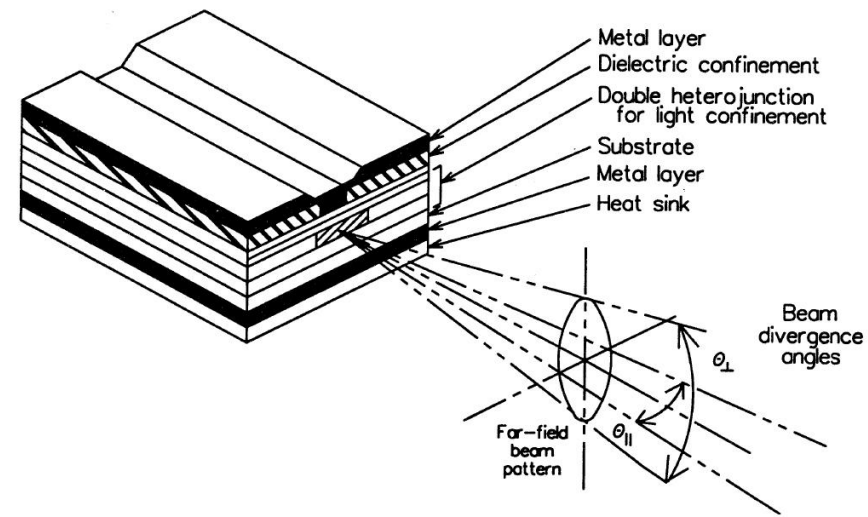

Fig. 5. Typical Radiation Pattern

ST1054



Directivitatea radiatiei exterioare

- ▶ Sursa lambertiana

$$P(\theta) = P_0 \cdot \cos \theta$$

- ▶ Aproximatie Lambertiana pentru surse cu directivitate crescuta

$$P(\theta) = P_0 \cdot \cos^n \theta$$

- ▶ Surse cu emisie asimetrica

$$P(\theta) = \frac{P_0}{\frac{\sin^2 \phi}{\cos^T \theta} + \frac{\cos^2 \phi}{\cos^L \theta}}$$

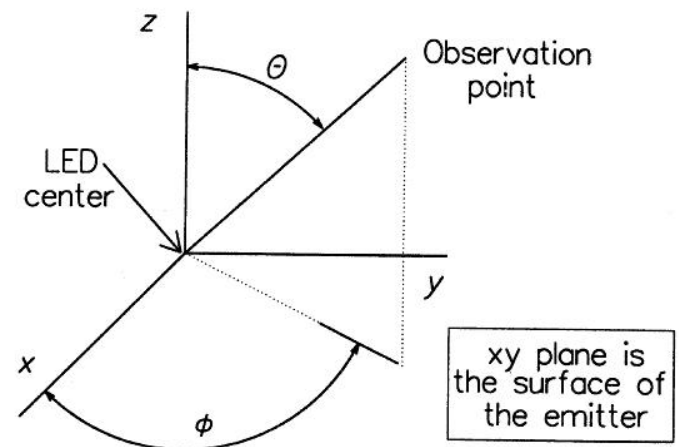
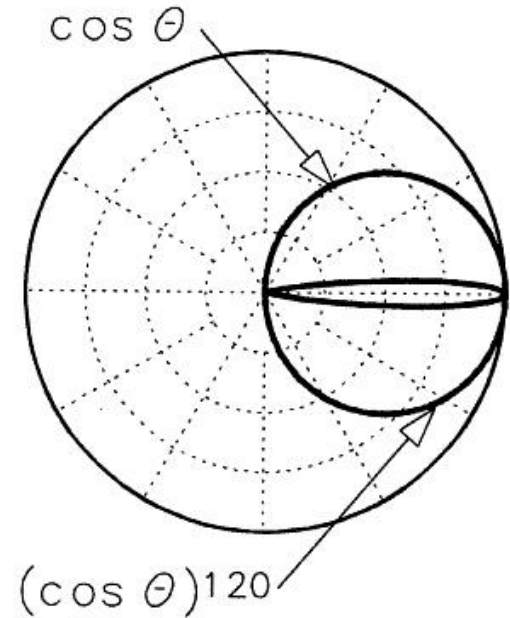

Profil de radiație a emițătorilor optici

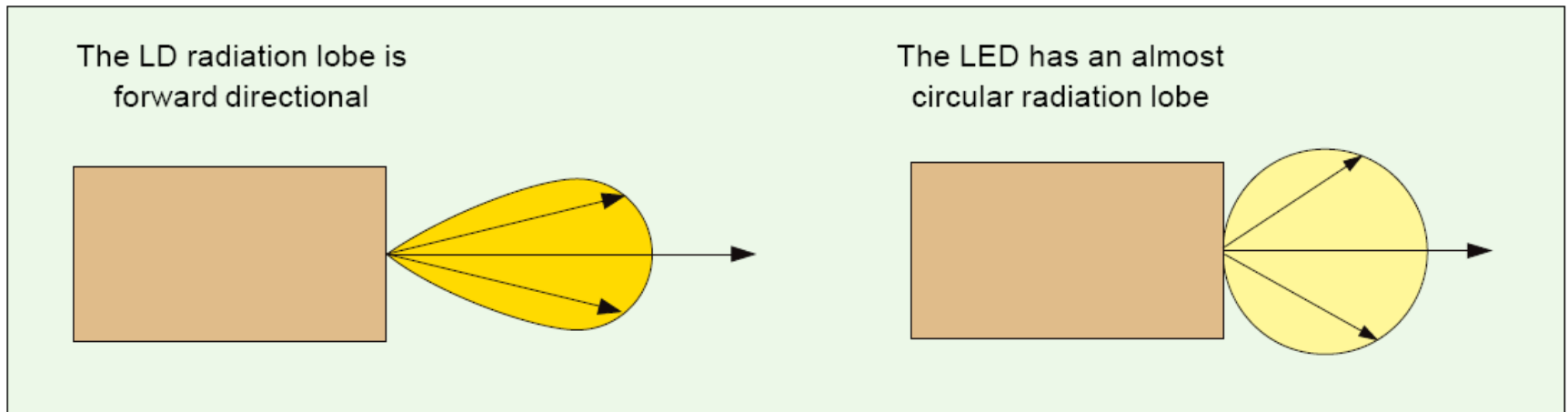

- ▶ Apertura numerică poate varia de la 0.9 pentru un LED de unghi foarte larg, la 0.2 pentru un LED prevăzut cu lentilă.
- ▶ Chiar și pentru un NA de 0.2, aria emisivă este mare comparativ cu a unui laser. În consecință, densitatea de putere emisă este mică astfel încât se reduce drastic puterea care poate fi cuplată într-o fibră cu indice gradat, și devine practic imposibilă cuplarea cu o fibră monomod.

Caracteristici putere optică/curent a emițătorilor optici

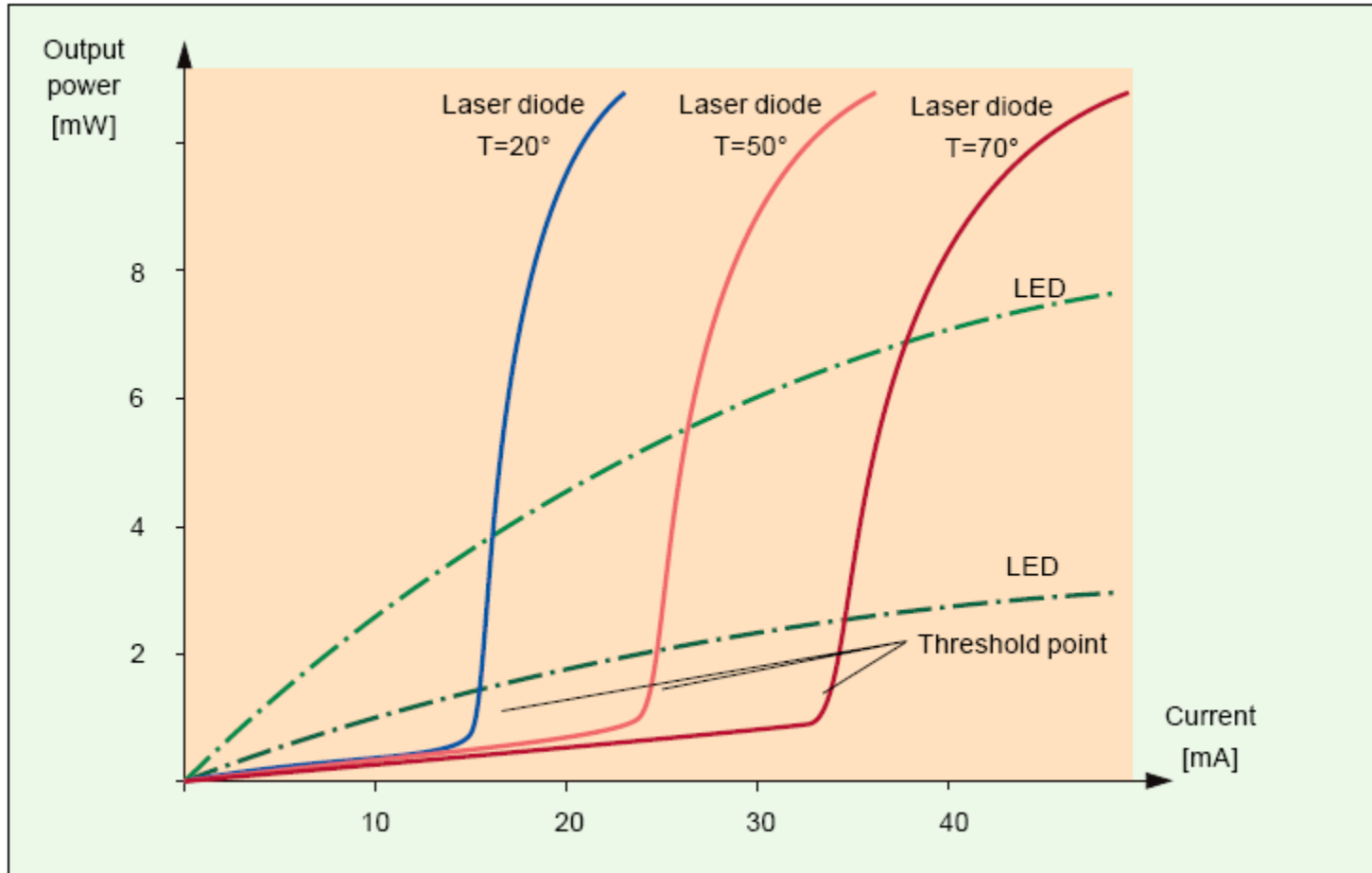

Caracteristica de raspuns a LED-urilor

- ▶ Caracteristica putere optica emisa functie de curentul direct prin LED este liniara la nivele mici ale curentului.
- ▶ Nu exista curent de prag
- ▶ La nivele foarte mari puterea optica se satureaza

- ▶ Responzivitatea

$$r = \frac{P_o}{I} \left[\frac{W}{A} \right]$$

- ▶ Tipic $r = 50 \mu\text{W}/\text{mA}$

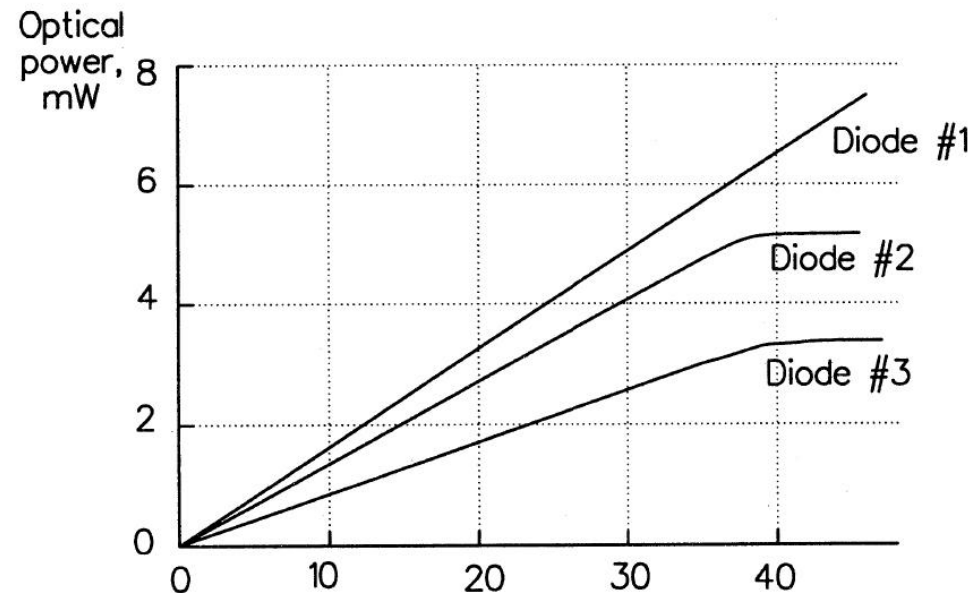

Caracteristica de raspuns a LED-urilor

- ▶ Tipic SLED au eficienta mai buna decat ELED

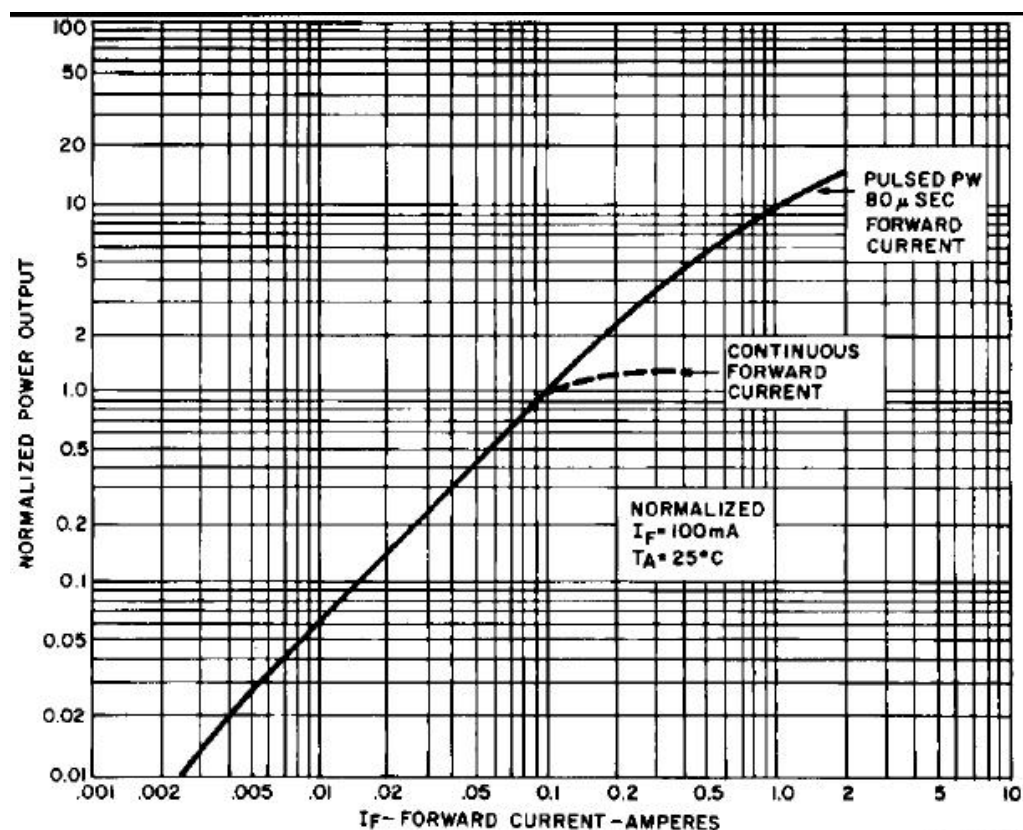
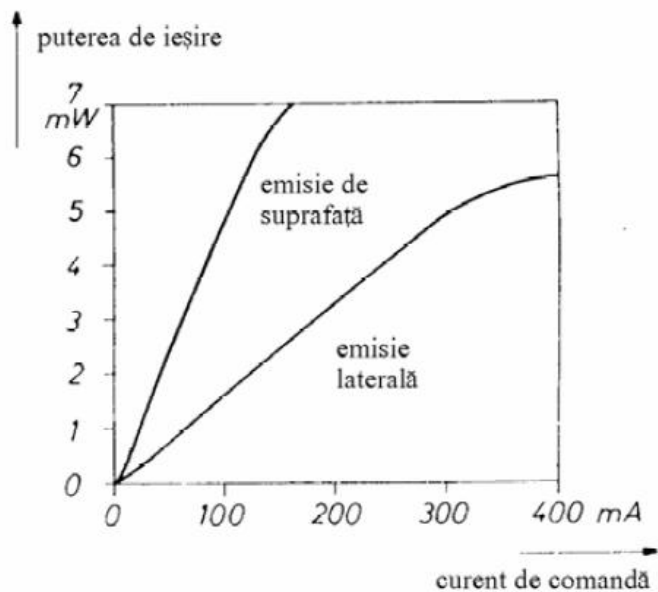
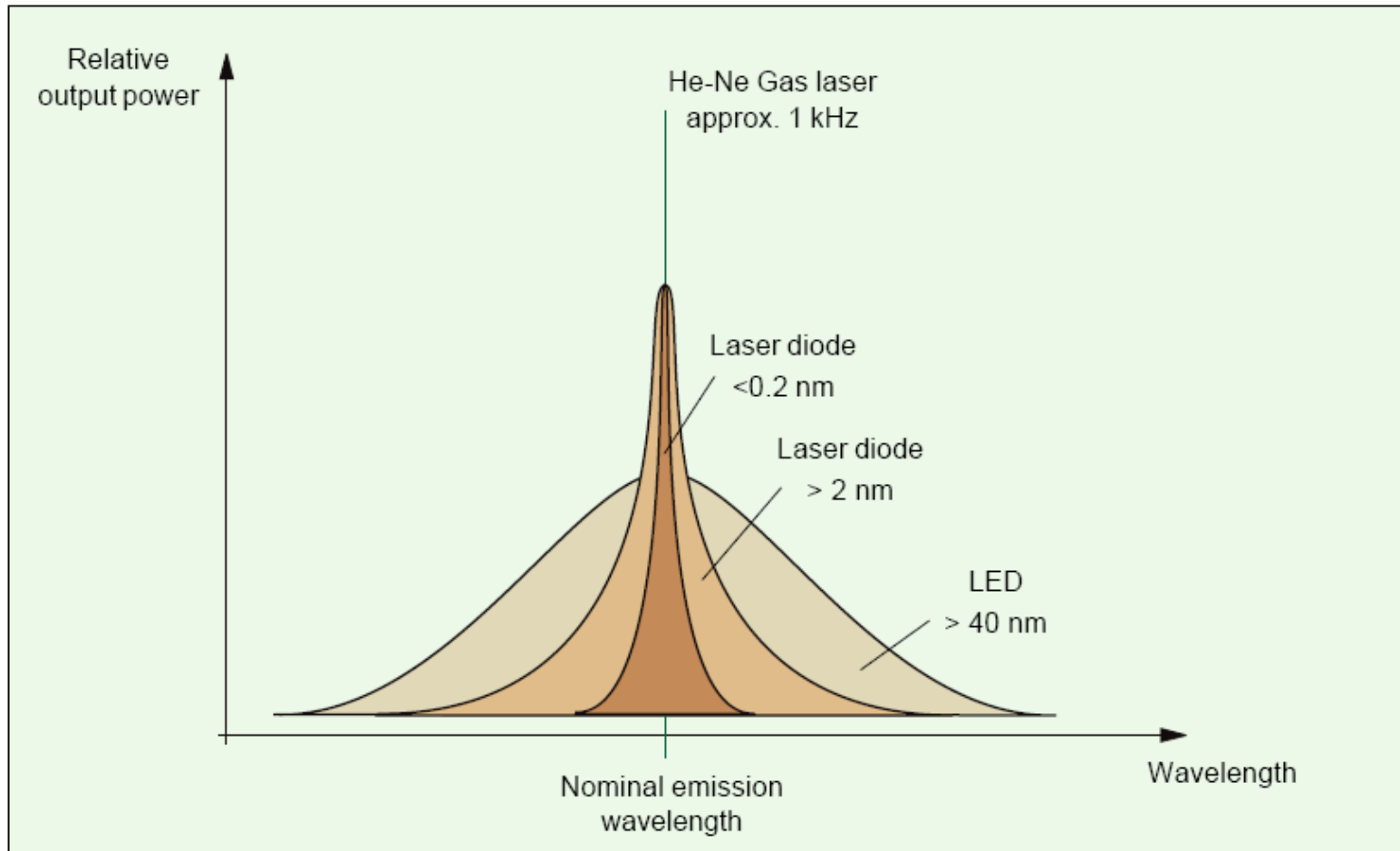

Fig. 1. Power Output vs. Input Current

ST1052

Calitatea spectrală a emițătorilor optici



Latimea spectrala a LED-urilor

- ▶ Aproximativ $\Delta\lambda \approx 0.05\lambda$
- ▶ Relatie empirica $\Delta\lambda[\mu m] \approx 1.45\lambda^2[\mu m](kT)[eV]$
- ▶ Tipic
 - GaAlAs – 20–40 nm
 - InGaAsP
 - SLED – 100 nm
 - ELED – 60–80 nm
 - GaInN – 30–40 nm (10%)

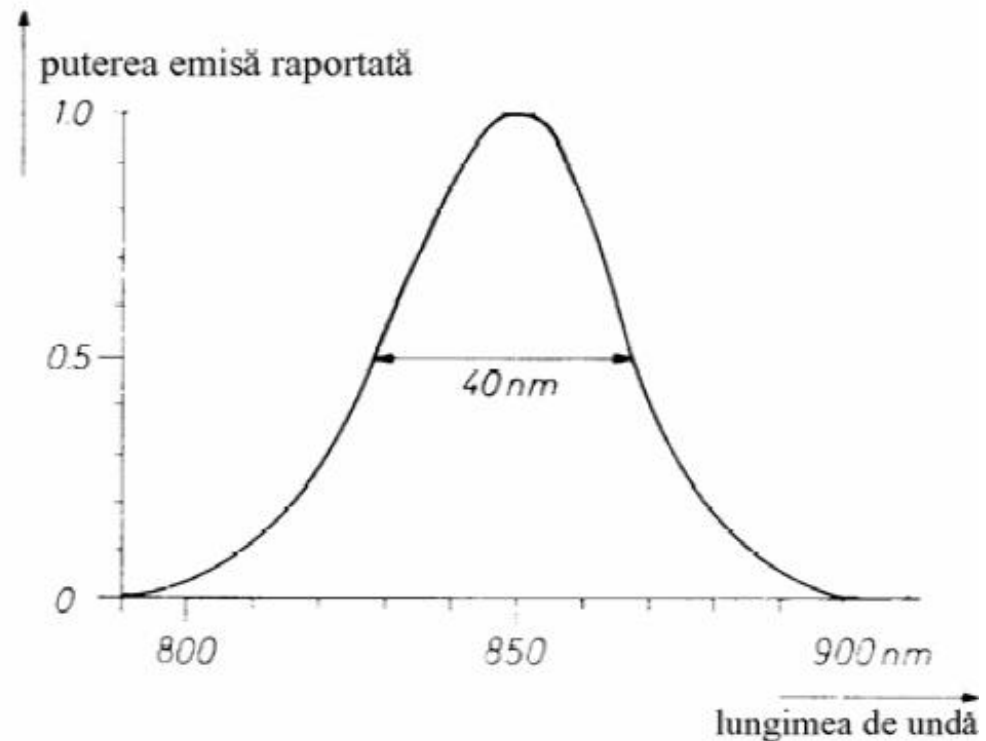

Comportare dinamica a LED

- ▶ Puterea de iesire la modulatia cu un semnal sinusoidal cu ω

$$P_{out} = \frac{P_o}{1 + \omega^2 \tau_{lf}^2}$$

- Puterea electrica variaza proportional cu patratul curentului
- Puterea optica variaza proportional cu curentul
- ▶ Banda la 3 dB electrica

$$\frac{P_{out}^2}{P_o^2} = \frac{1}{2}$$

$$f_{3dB-el} = \frac{1}{2 \cdot \pi \cdot \tau_{lf}}$$

- Banda la 3 dB optic

$$\frac{P_{out}}{P_o} = \frac{1}{2}$$

Comportare dinamica a LED

- ▶ Cand curentul care trece prin dispozitiv e mic timpul de viata al purtatorilor e independent de curent si este dependent liniar de nivelul de dopare in regiunea activa
- ▶ Cand curentul este mare timpul de viata al purtatorilor este proportional cu \sqrt{d} si invers proportional cu \sqrt{J}
- ▶ Banda poate fi crescuta
 - Crescand nivelul de dopare
 - Reducand inaltimea zonei active
 - Crescand densitatea de curent

Comportare dinamica a LED

- ▶ In domeniul timp
- ▶ Timpul de crestere (rise time)

$$t_r = 2.20 \cdot \left(\frac{2 \cdot k \cdot T \cdot C_s}{e \cdot I_p} + \tau_{lf} \right)$$

- ▶ Capacitatea asociata sarcinilor in regiunea activa: 350 ÷ 1000pF
- ▶ Produs Putere × Banda

$$P \times \Delta f = \frac{h \cdot c}{2 \cdot \pi \cdot e \cdot \lambda} \cdot \frac{J}{\tau_{lf}}$$

Aplicatii majore LED

- ▶ Comunicatii
 - Infrarosu (InGaAsP)
- ▶ Vizibil
 - Spectru vizibil (GaAlAs)
- ▶ Iluminare
 - Putere ridicata, lumina alba (GaInN)

LED albastru

- ▶ bazat pe GaInAs
- ▶ dezvoltare tardiva (GaN)

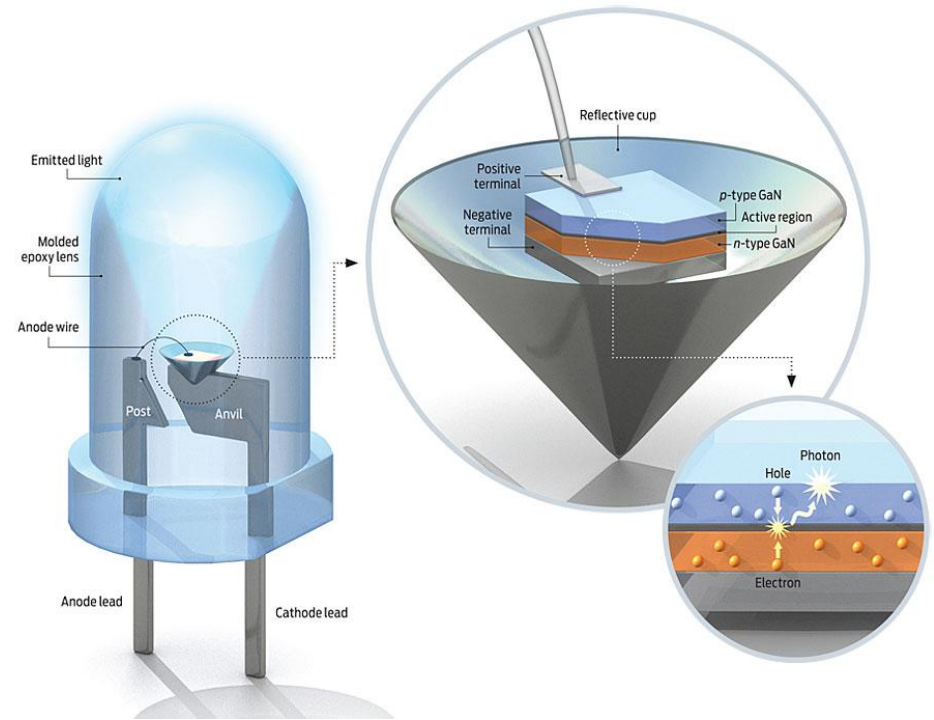
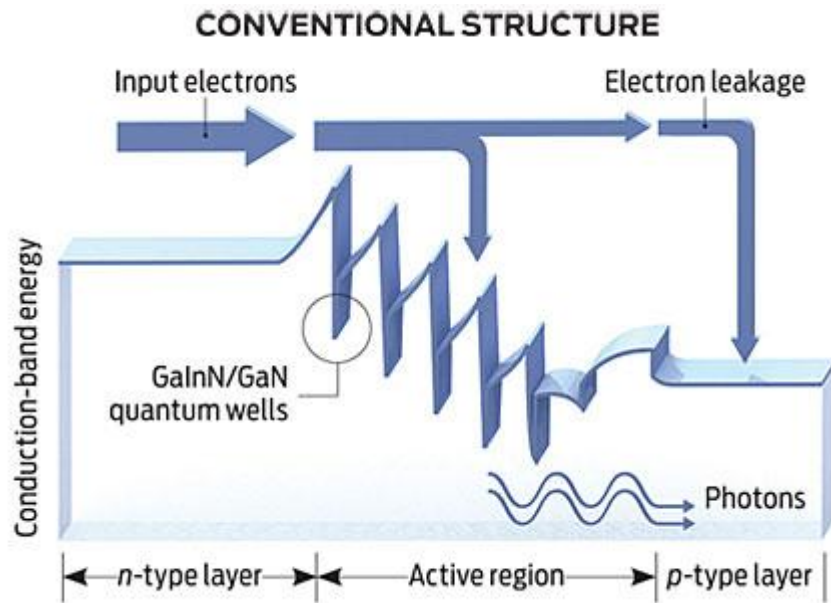

LED albastru

- realizare: GaInN Quantum Well/GaN

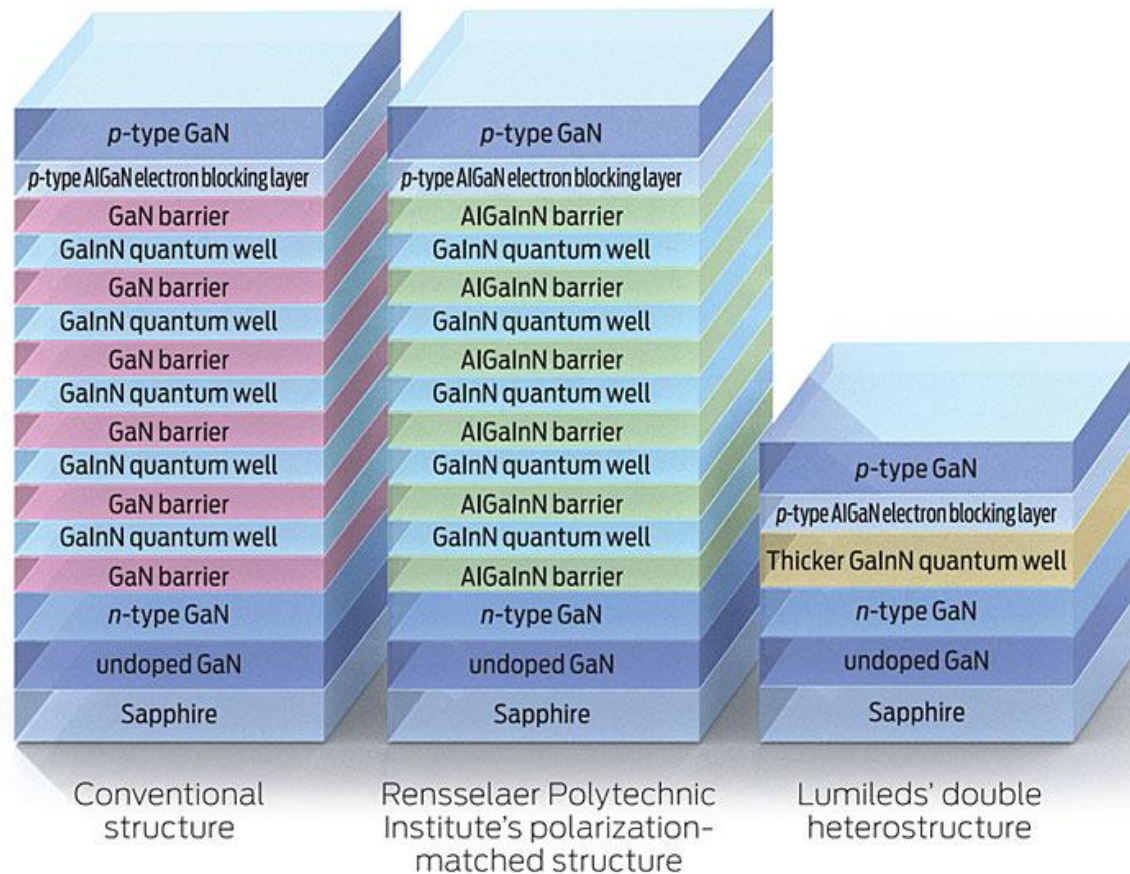

Spectru LED albastru

- ▶ $\Delta\lambda$ relativ la λ mai mare

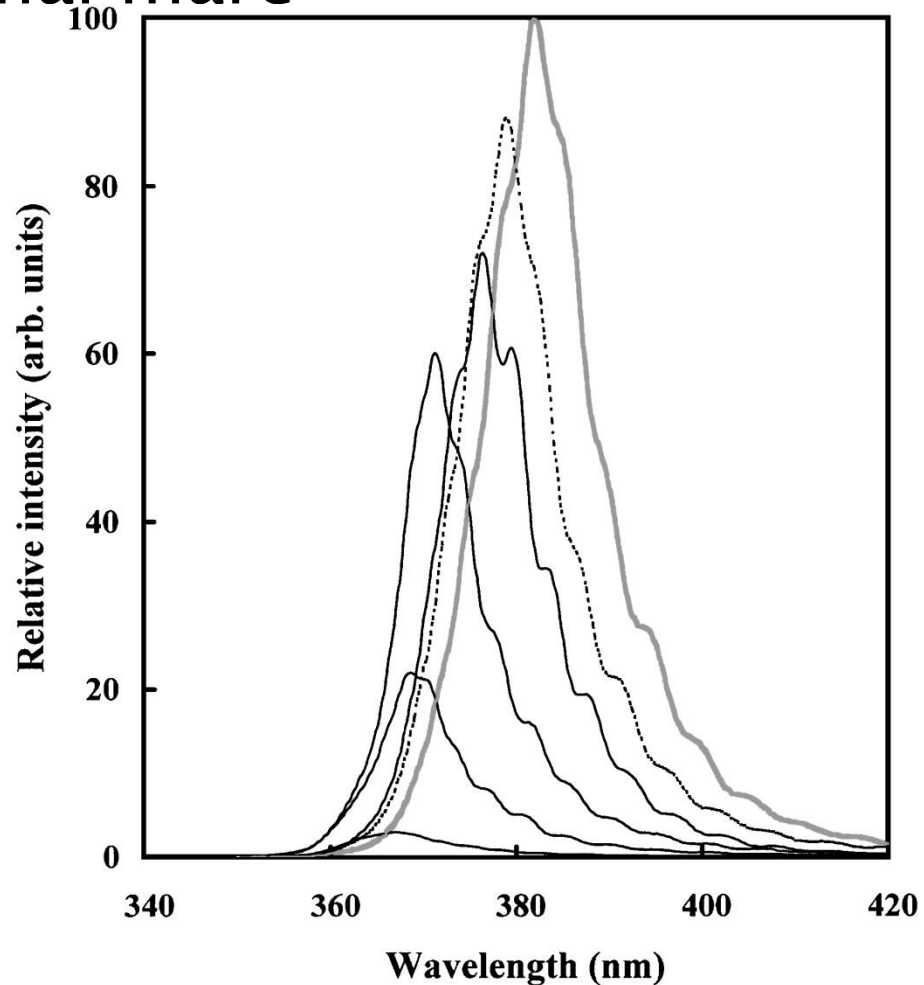

Eficiencia cuantica

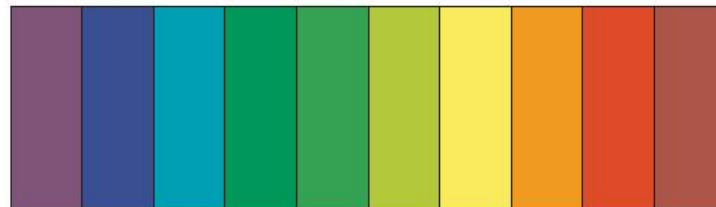
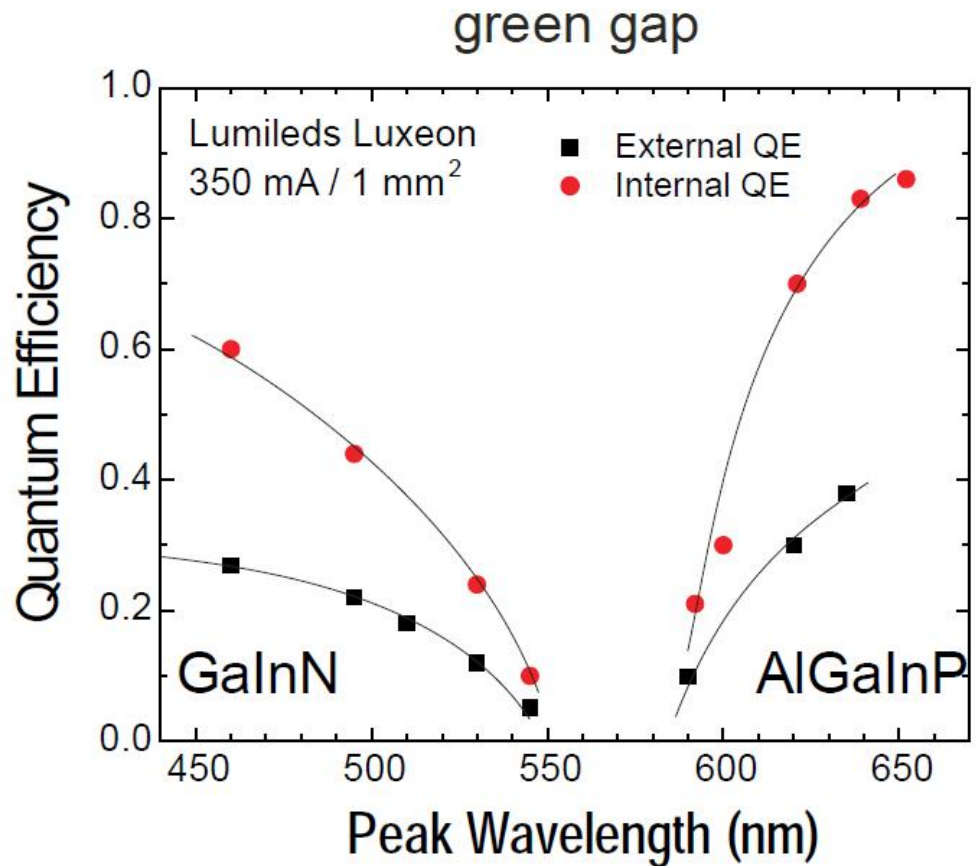

Culori/materiale - 1

Color	Wavelength (nm)	Voltage (V)	Semiconductor Material
Infrared	$\lambda > 760$	$\Delta V < 1.9$	Gallium arsenide (GaAs) Aluminium gallium arsenide (AlGaAs)
Red	$610 < \lambda < 760$	$1.63 < \Delta V < 2.03$	Aluminium gallium arsenide (AlGaAs) Gallium arsenide phosphide (GaAsP) Aluminium gallium indium phosphide (AlGaInP) Gallium(III) phosphide (GaP)
Orange	$590 < \lambda < 610$	$2.03 < \Delta V < 2.10$	Gallium arsenide phosphide (GaAsP) Aluminium gallium indium phosphide (AlGaInP) Gallium(III) phosphide (GaP)
Yellow	$570 < \lambda < 590$	$2.10 < \Delta V < 2.18$	Gallium arsenide phosphide (GaAsP) Aluminium gallium indium phosphide (AlGaInP) Gallium(III) phosphide (GaP)
Green	$500 < \lambda < 570$	$1.9 < \Delta V < 4.0$	Indium gallium nitride (InGaN) / Gallium(III) nitride (GaN) Gallium(III) phosphide (GaP) Aluminium gallium indium phosphide (AlGaInP) Aluminium gallium phosphide (AlGaP)

Culori/materiale - 2

Color	Wavelength (nm)	Voltage (V)	Semiconductor Material
Blue	$450 < \lambda < 500$	$2.48 < \Delta V < 3.7$	Zinc selenide (ZnSe) Indium gallium nitride (InGaN) Silicon carbide (SiC) as substrate Silicon (Si) as substrate — (under development)
Violet	$400 < \lambda < 450$	$2.76 < \Delta V < 4.0$	Indium gallium nitride (InGaN)
Purple	multiple types	$2.48 < \Delta V < 3.7$	Dual blue/red LEDs, blue with red phosphor, or white with purple plastic
Ultraviolet	$\lambda < 400$	$3.1 < \Delta V < 4.4$	Diamond (235 nm) Boron nitride (215 nm) Aluminium nitride (AlN) (210 nm) Aluminium gallium nitride (AlGaInN) — (down to 210 nm)
White	Broad spectrum	$\Delta V = 3.5$	Blue/UV diode with yellow phosphor

Denumiri tipice – LED



Wavelength (nm)	Color Name
940	Infrared
880	Infrared
850	Infrared
660	Ultra Red
635	High Eff. Red
633	Super Red
620	Super Orange
612	Super Orange
605	Orange
595	Super Yellow
592	Super Pure Yellow
585	Yellow
4500K	"Incandescent" White
6500K	Pale White
8000K	Cool White
574	Super Lime Yellow
570	Super Lime Green
565	High Efficiency Green
560	Super Pure Green
555	Pure Green
525	Aqua Green
505	Blue Green
470	Super Blue
430	Ultra Blue

Aplicatii majore LED

- ▶ Comunicatii
 - Infrarosu (InGaAsP)
- ▶ Vizibil
 - Spectru vizibil (GaAlAs)
- ▶ Illuminare
 - Putere ridicata, lumina alba (GaInN)

Eficiența

- ▶ Bec cu incandescenta
 - 16 lm/W
- ▶ Tub fluorescent
 - 100 lm/W
- ▶ LED
 - curent: 250 lm/W
 - curand: 300 lm/W

Eficienta in timp

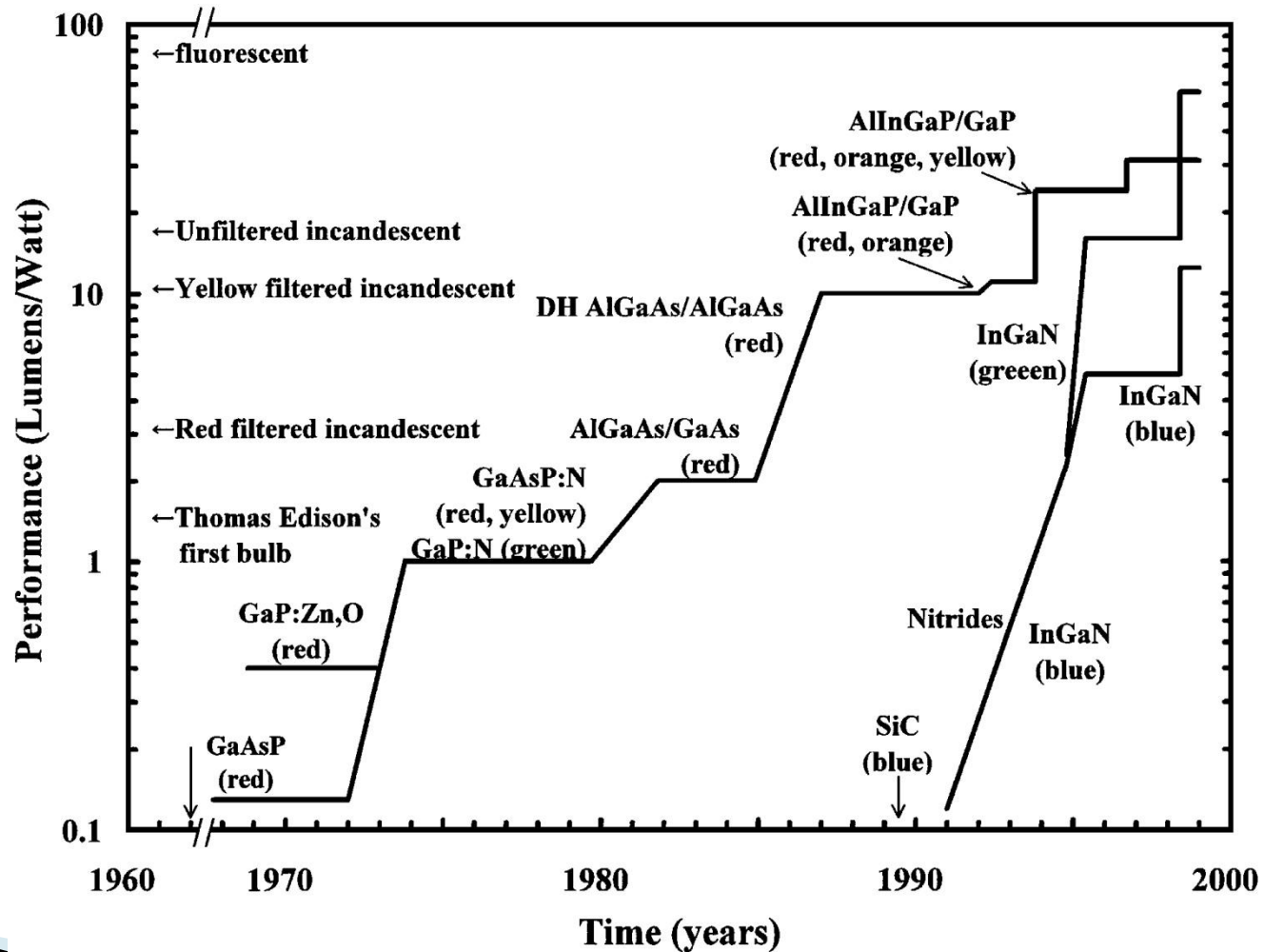

Eficienta in timp

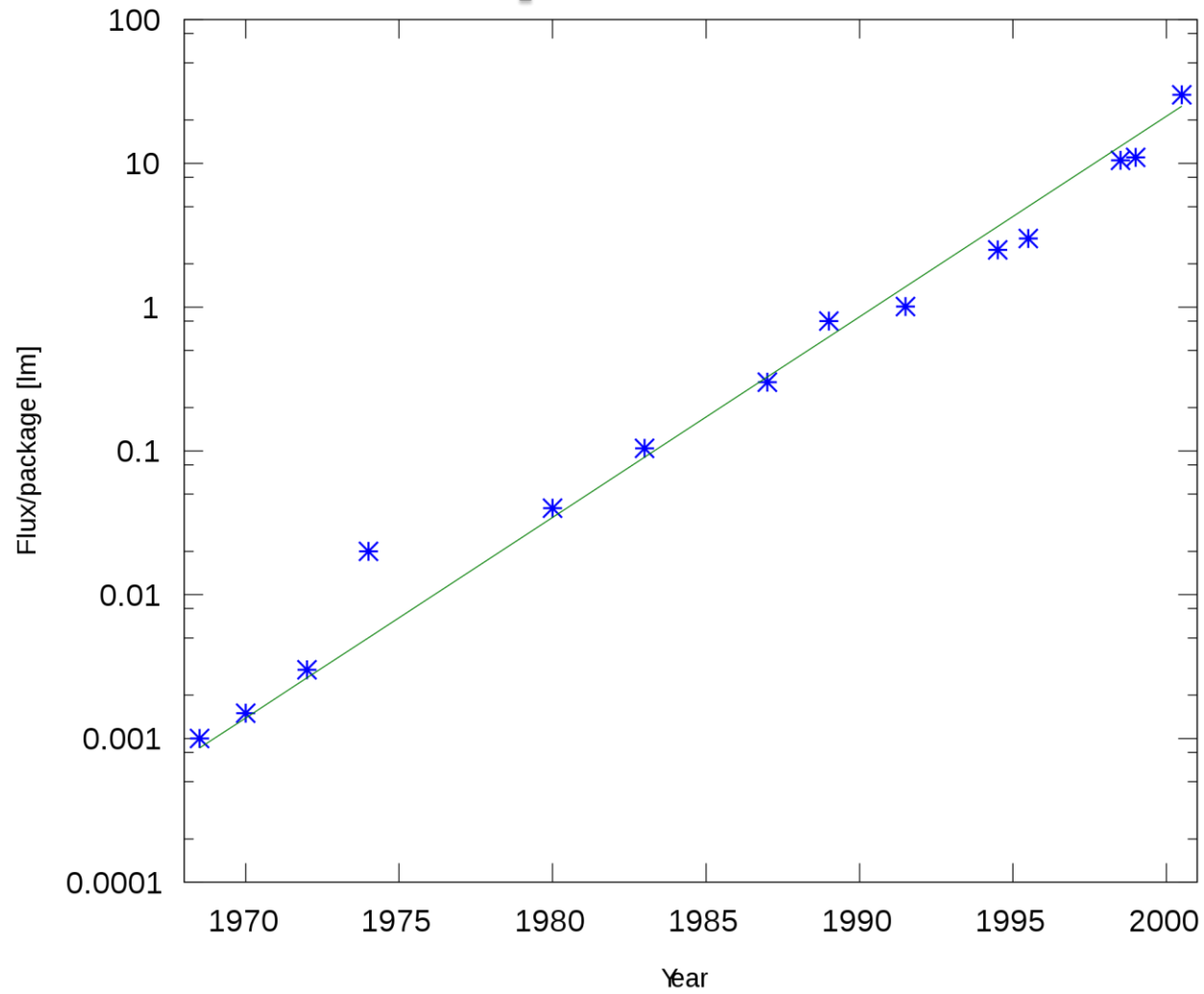

Culoare alba

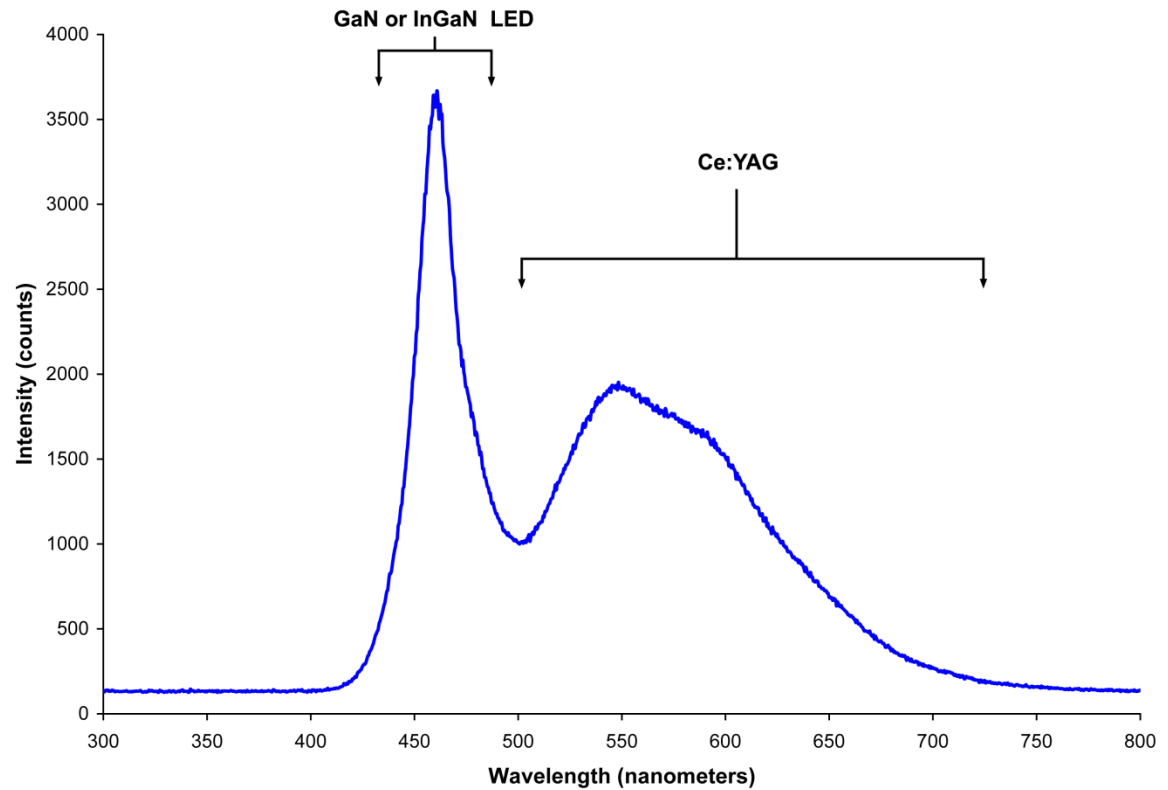
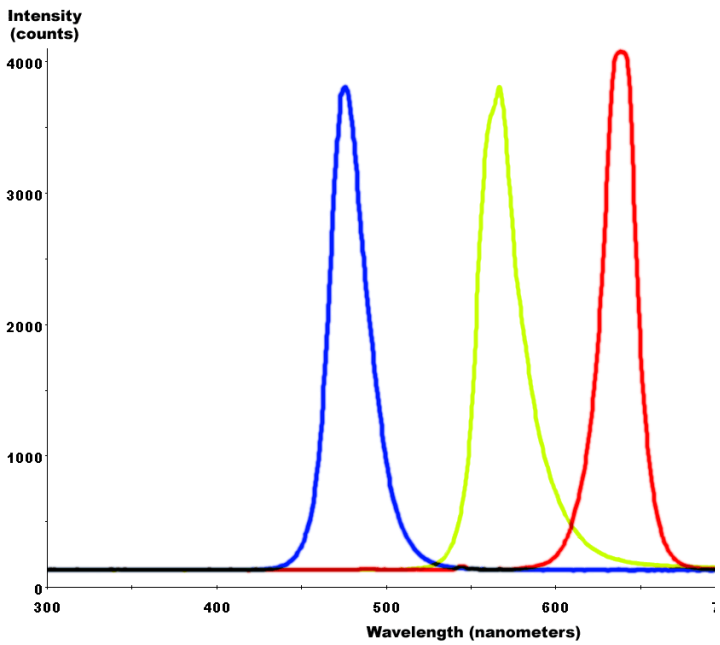

Fosfor activat de LED albastru/UV

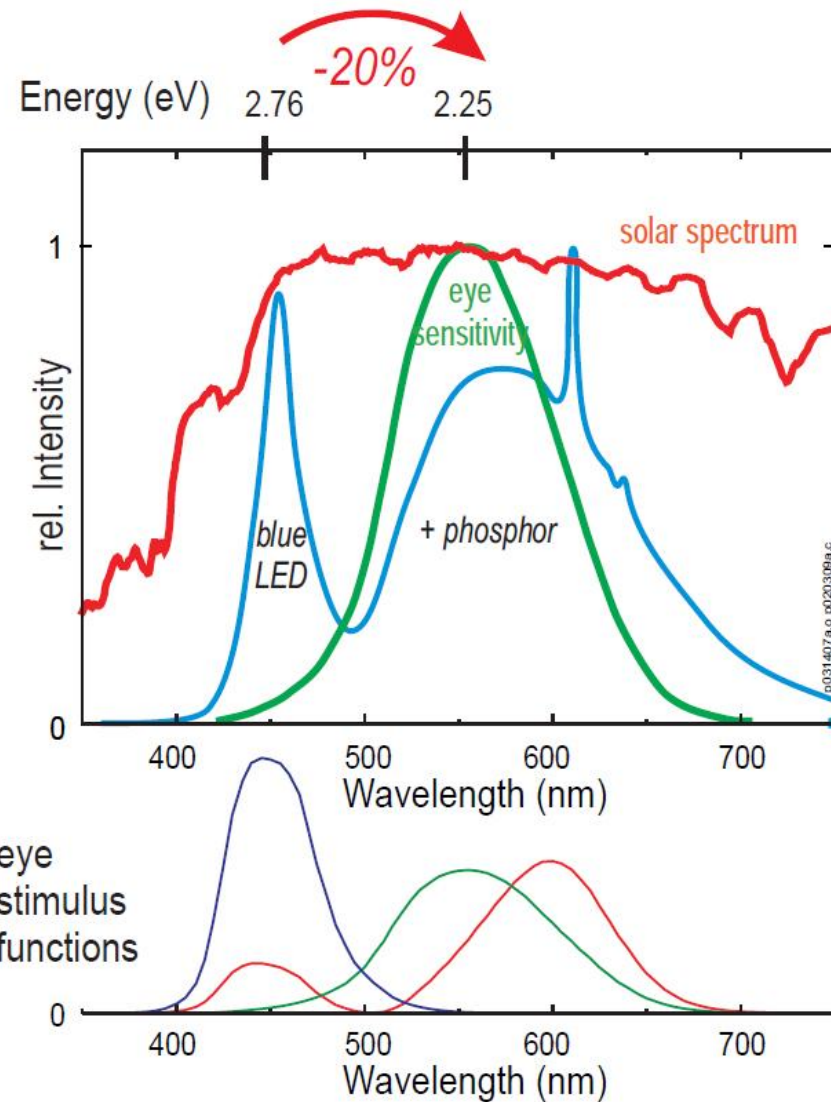

Realizare LED de putere

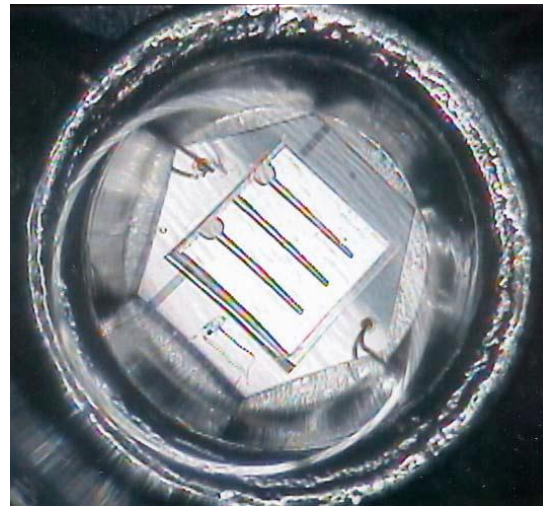
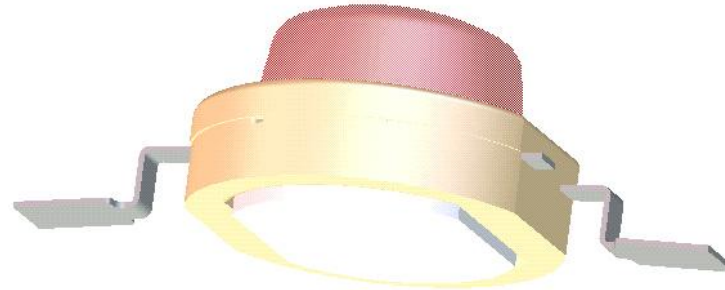
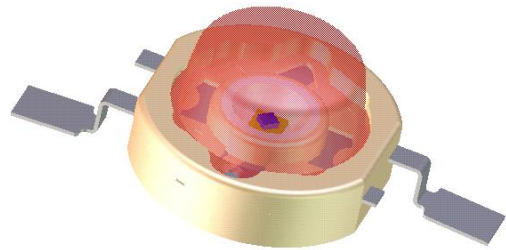

Realizare LED de putere

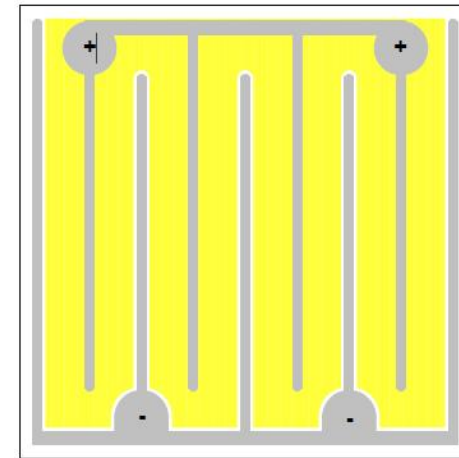
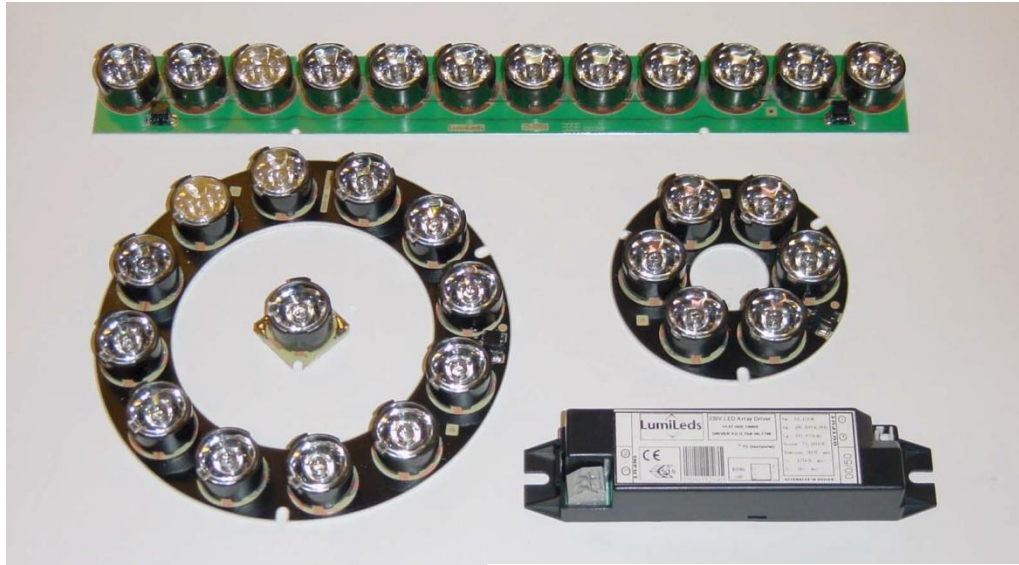

$A_{\text{chip}} \sim 1 \times 1 \text{ mm}^2$; $N = 4$

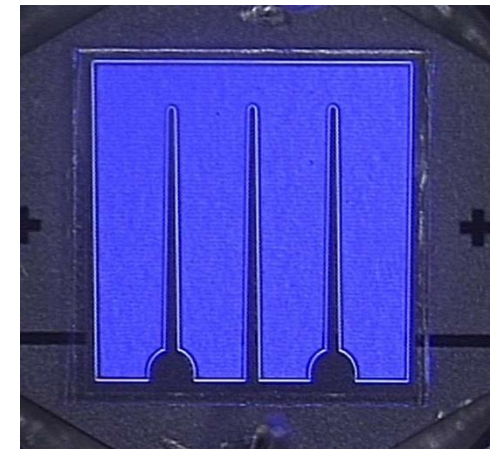
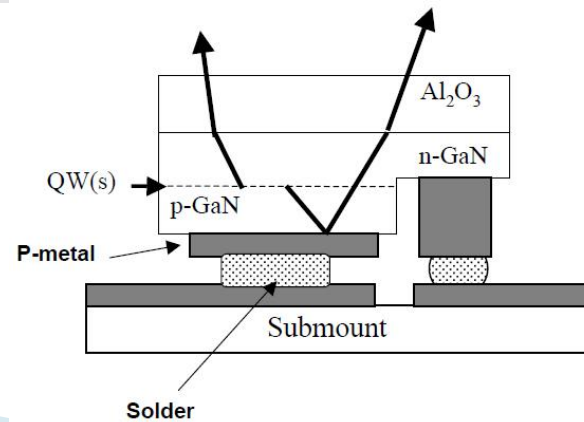

Performanta

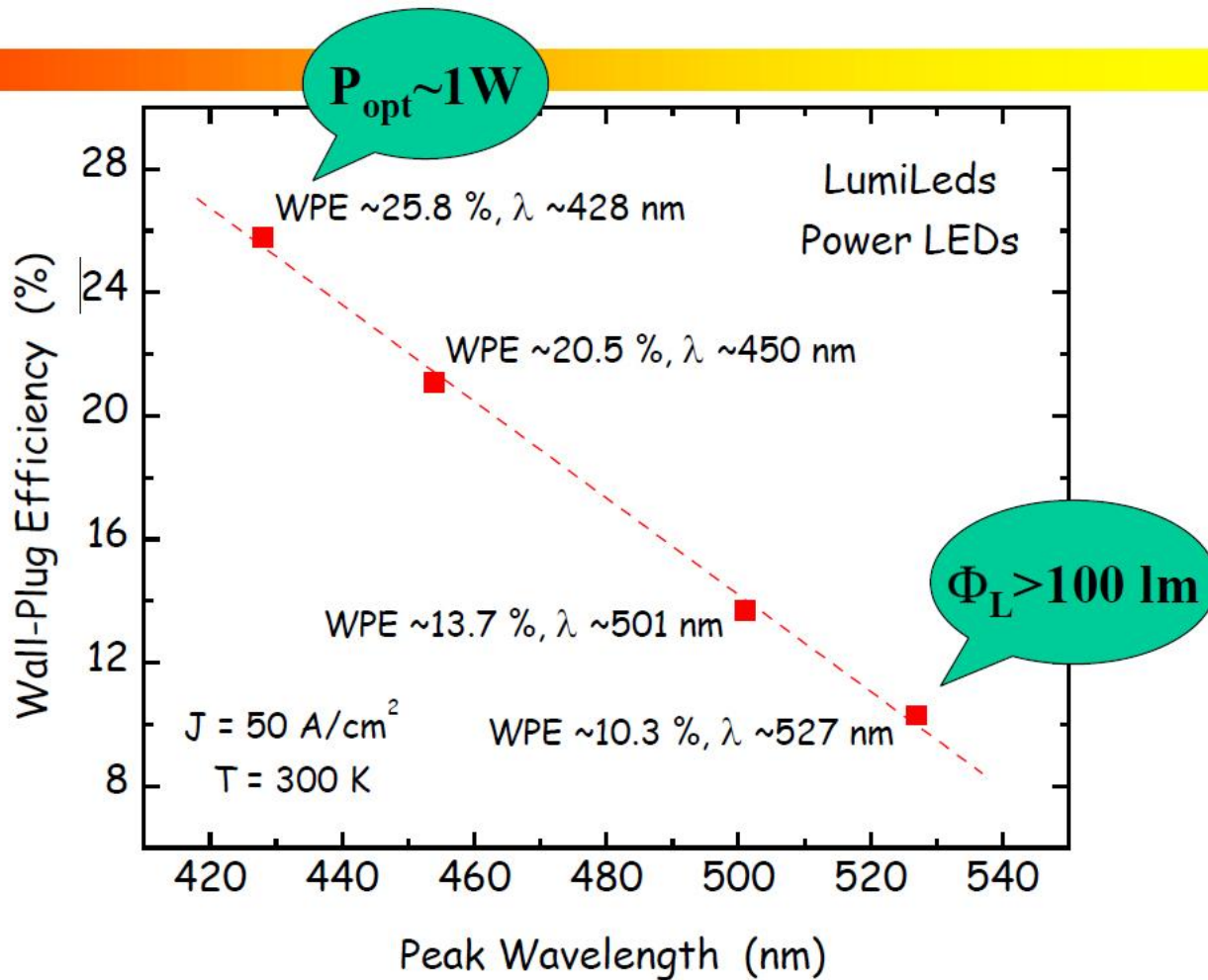

Aplicatii

- ▶ auto



Aplicatii

▶ auto

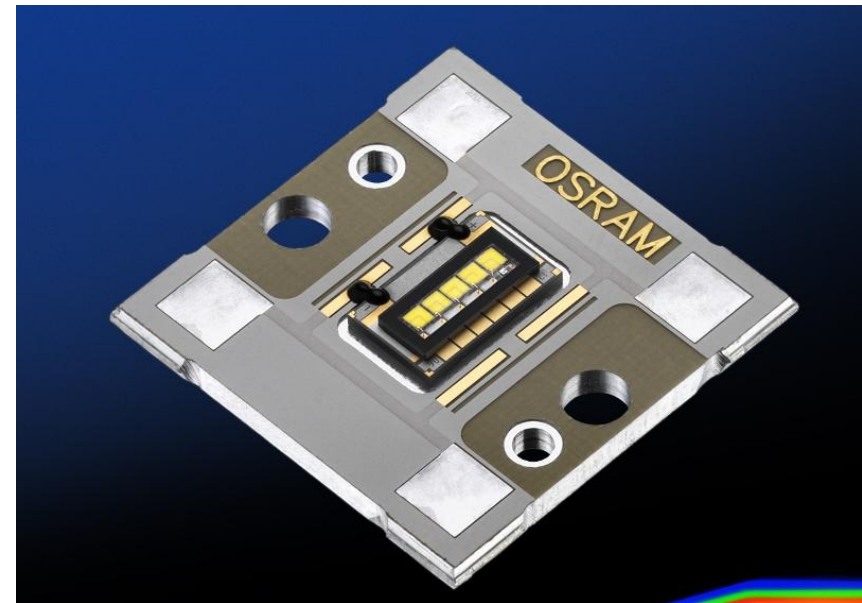

Avantaje

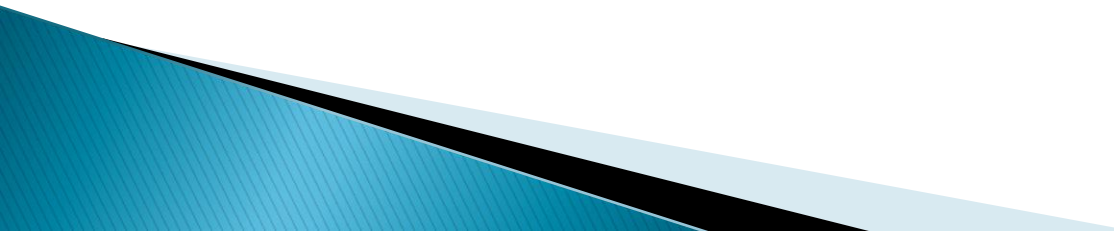
- ▶ Eficienta
 - ▶ Culoare usor de implementat (nativ)
 - ▶ Dimensiune
 - ▶ Timp de raspuns
 - ▶ Reglaj al intensitatii luminoase
 - ▶ Radiatie de caldura (IR) redusa
 - ▶ Timp de viata
 - ▶ Rezistenta la socuri
 - ▶ Directivitatea luminii (nativ)
- 

Dezavantaje

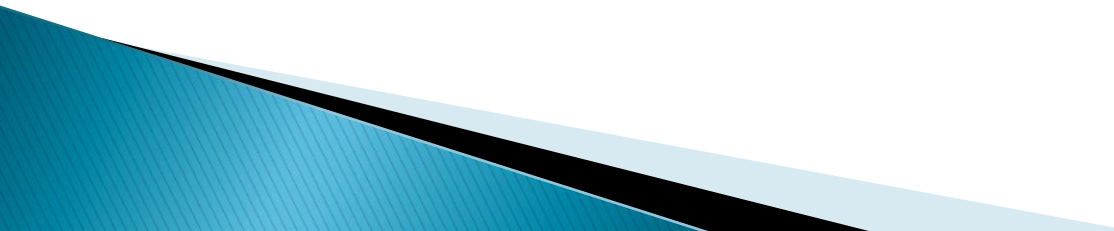
- ▶ Pret
 - ▶ Dependenta de temperatura
 - ▶ Sensibilitate la tensiune (prag)
 - ▶ Calitatea luminii (corp negru)
 - ▶ Directivitate (sursa de suprafata/punctuala)
- 

OLED

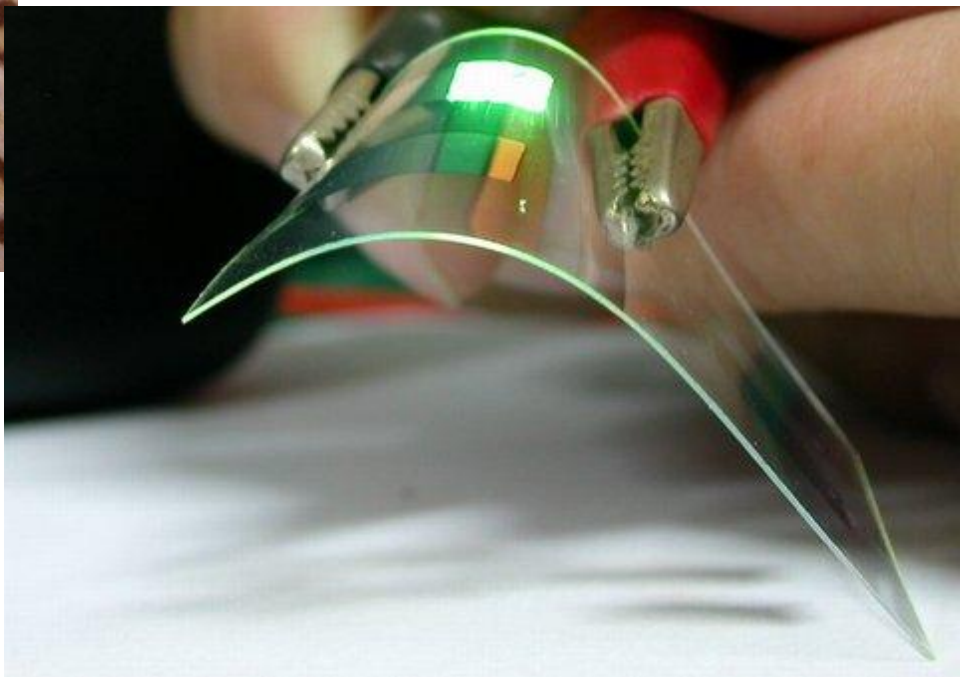

Limite putere/bandă a dispozitivelor optoelectronice

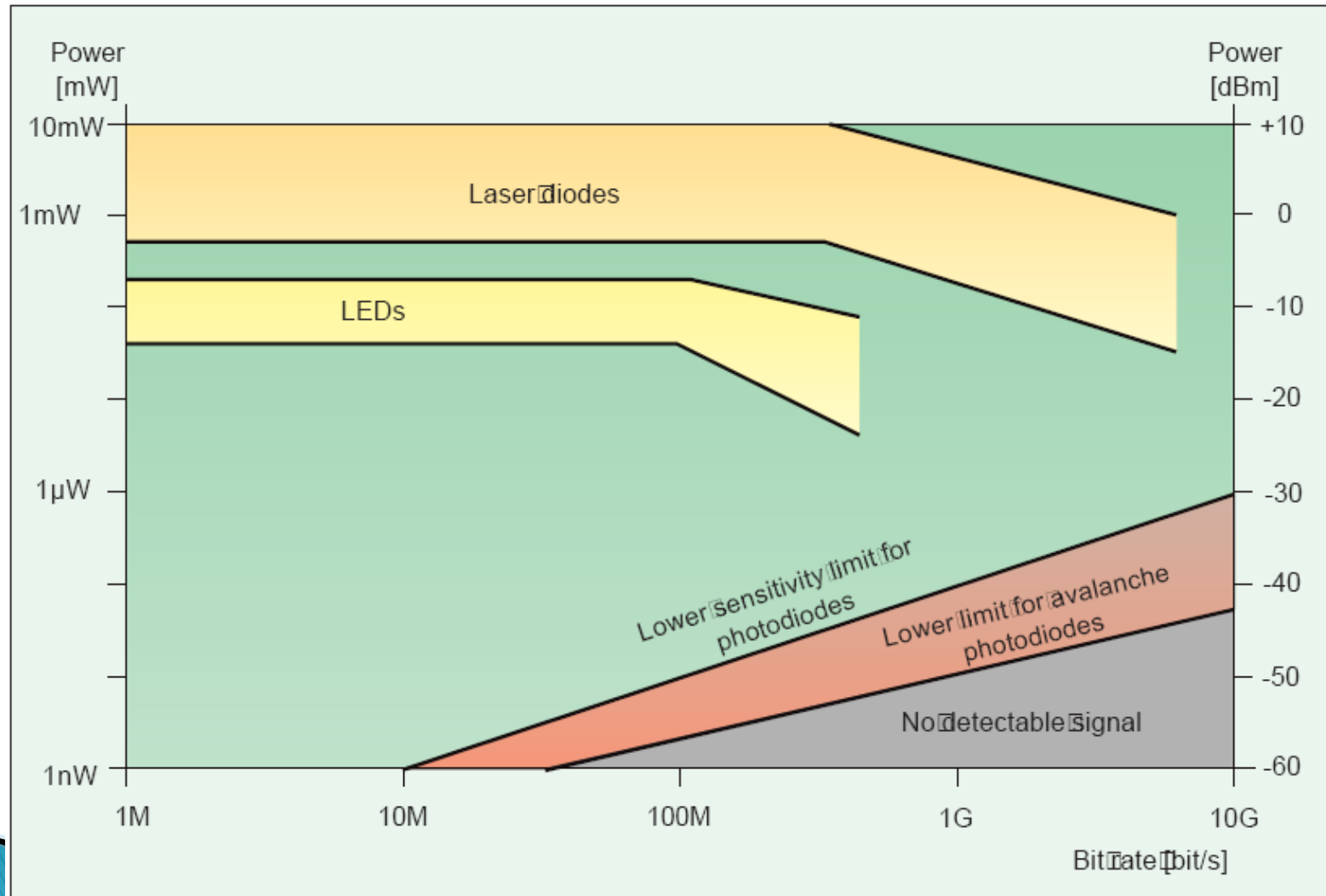

Contact

- ▶ Laboratorul de microunde si optoelectronica
- ▶ <http://rf-opto.etti.tuiasi.ro>
- ▶ rdamian@etti.tuiasi.ro